



**Where  
Automation  
Connects.**

## Technical Note



# ILX56-MM Redundant ProSoft Tested

**Document Code: TN2009\_ILX56-MM\_Redundant\_Tested**  
 Author: Ken Roslan  
 Date: April 2010



### Asia Pacific

#### Malaysia Office

Phone: +603.7724.2080  
 asiapc@prosoft-technology.com  
*Languages spoken: Chinese, English, Japanese*

#### China Office

Phone: +86.21.5187.7337  
 asiapc@prosoft-technology.com  
*Languages spoken: Chinese, English*

### Europe

#### France Office

Phone: +33 (0)5.34.36.87.20  
 support.emea@prosoft-technology.com  
*Languages spoken: French, English*

#### Middle East and Africa

Phone: +971.(0)4.214.6911  
 mea@prosoft-technology.com  
*Languages spoken: English, Hindi*

### North America

#### California and Wisconsin Offices

Phone: +1 661.716.5100  
 support@prosoft-technology.com  
*Languages spoken: English, Spanish*

### Latin America

#### Brasil Office

Phone: +55.11.5083.3776  
 brasil@prosoft-technology.com  
*Languages spoken: Portuguese, English*

#### Mexico and Central America Office

Phone: +52.222.3.99.6565  
 soporte@prosoft-technology.com  
*Languages spoken: Spanish, English*

#### Regional Office

Phone: +1.281.298.9109  
 latinam@prosoft-technology.com  
*Languages spoken: Spanish, English*

## Overview

### Introduction

This document and matching ladder provide a template of how to setup the ILX56-MM for applications requiring redundant modules. The example ladder checks the health of the ILX56-MMs, selects the valid ILX56-MM transfer data to be used by the ControlLogix program and supplies diagnostic tags. This example uses two ILX56-MMs in the same rack as the ControlLogix processor. This code will support using two ILX56-MMs in separate remote racks. The RSLogix 5000 project would have to be modified to add the ILX56-MMs in their respective remote racks and modify the ladder to point to the new module addresses. This example has data transferring to a ControlLogix from: a SLC 5/05 through a 1756-ENBT, a Siemens S7 controller through the ILX56-MM's on board Ethernet port, and a ProSoft Modbus TCP/IP gateway through the ILX56-MM's on board Ethernet port. This same method would need to be used for all ILX56-MM data transfers.

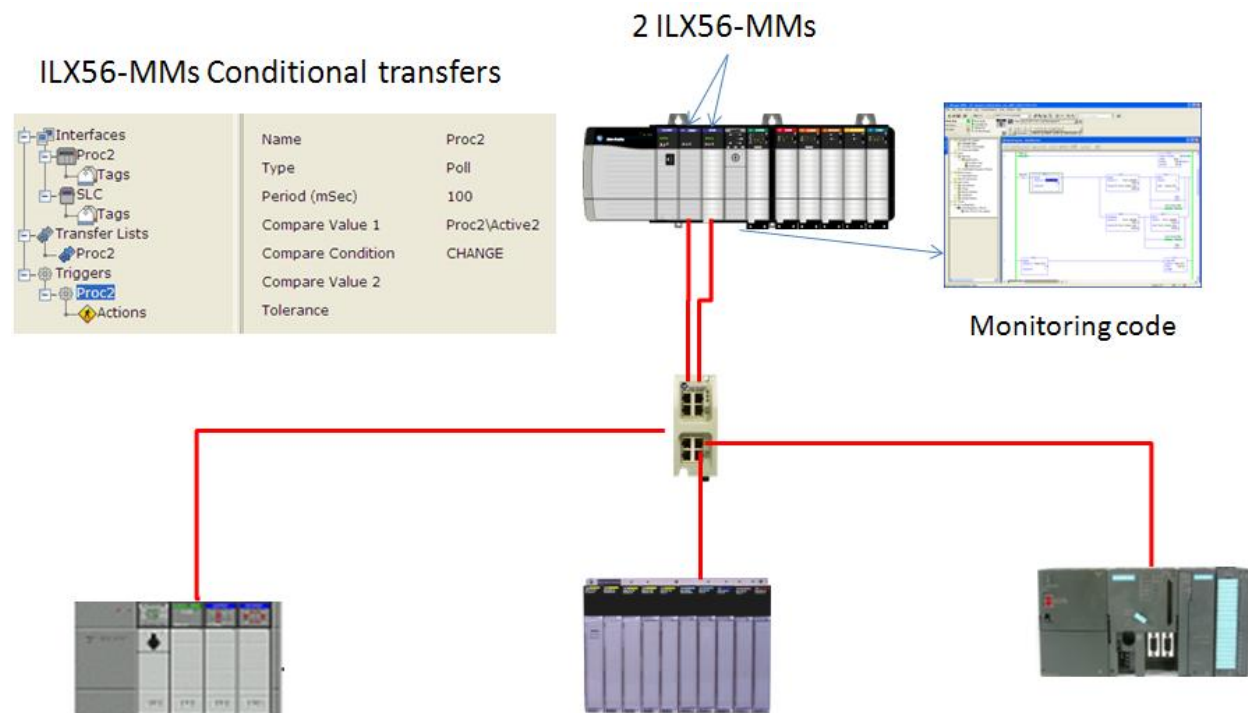

## Configuration Option

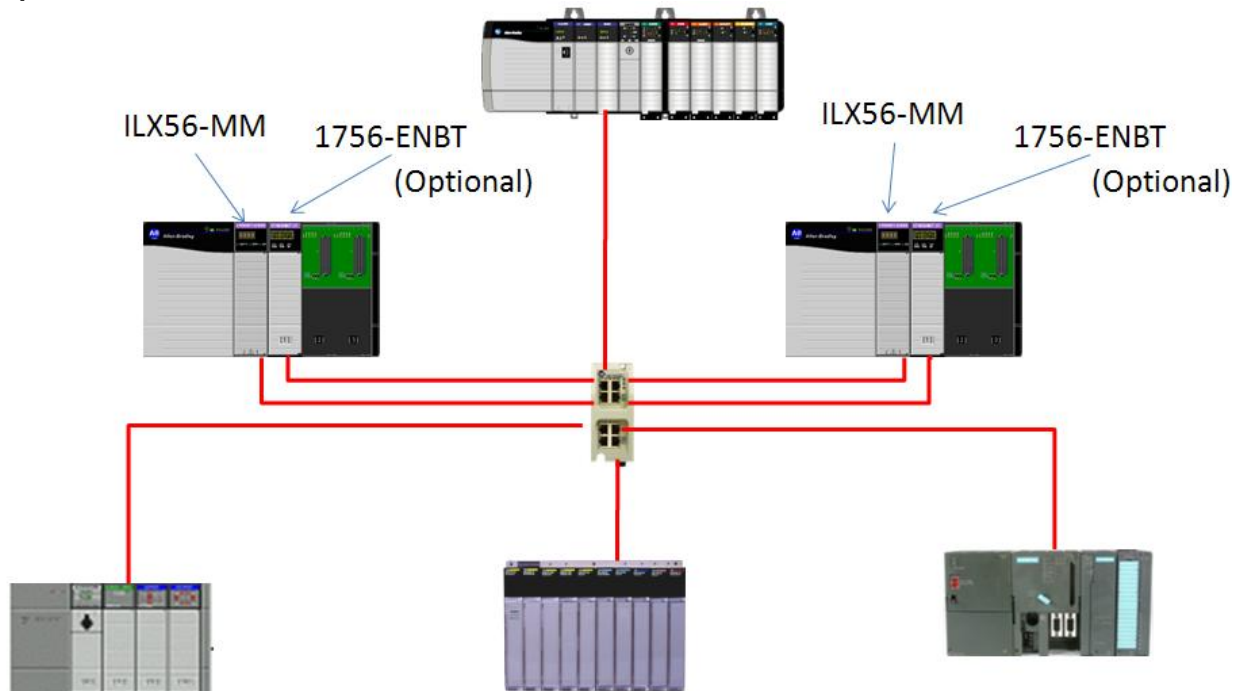

## Trigger options:

The ladder supports a number of different redundant operation modes depending on the trigger mode configured in the ILX56-MMs using Internet Explorer.

### 1) Always

This option has both ILX56-MM modules continually running and talking to the devices in their lists. The ladder will only use data from one module but will switch over to the other module in the event of a failure. This will have the fastest switchover time but will use twice as much network bandwidth and PAC/PLC communication resources. The code is used only to monitor module status and communication errors.

### 2) Change

This option has only one ILX56-MM module communicating to the PAC/PLCs at a time. The code will cause a switch over on an ILX56-MM failure or if the ILX56-MM is placed in "Idle" mode. All transfers will stop if the ControlLogix is not in "Run" mode. The tags "ILX\_MM\_1\_On\_Change" and "ILX\_MM\_2\_On\_Change" are used for this option.

### 3) Equal

This option has only one ILX56-MM module communicating to the PAC/PLCs at a time based on the tag "ILX\_MM\_Active". The code will cause a switch over on an ILX56-MM failure or if the ILX56-MM is placed in "Idle" mode. This has the ILX56-MM transferring data even when the ControlLogix is in the "Program" mode.

### Example ILX56-MM "Always" Option Trigger configuration

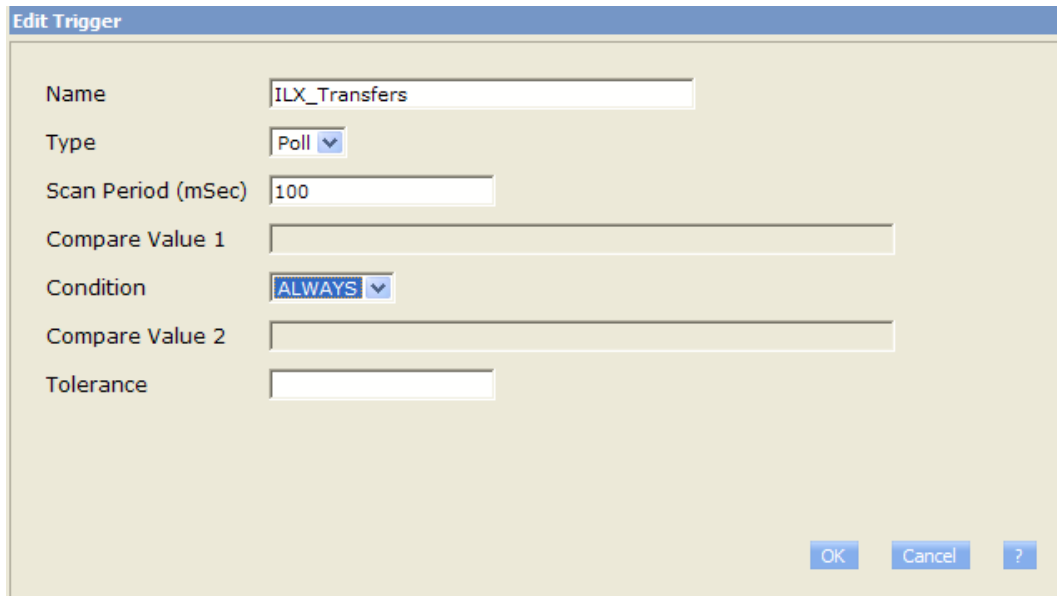

The screenshot shows the 'Edit Trigger' dialog box with the following configuration:

- Name: ILX\_Transfers
- Type: Poll
- Scan Period (mSec): 100
- Compare Value 1: (empty)
- Condition: ALWAYS
- Compare Value 2: (empty)
- Tolerance: (empty)

Buttons at the bottom: OK, Cancel, ?

### Example ILX56-MM "Change" Option Trigger configuration

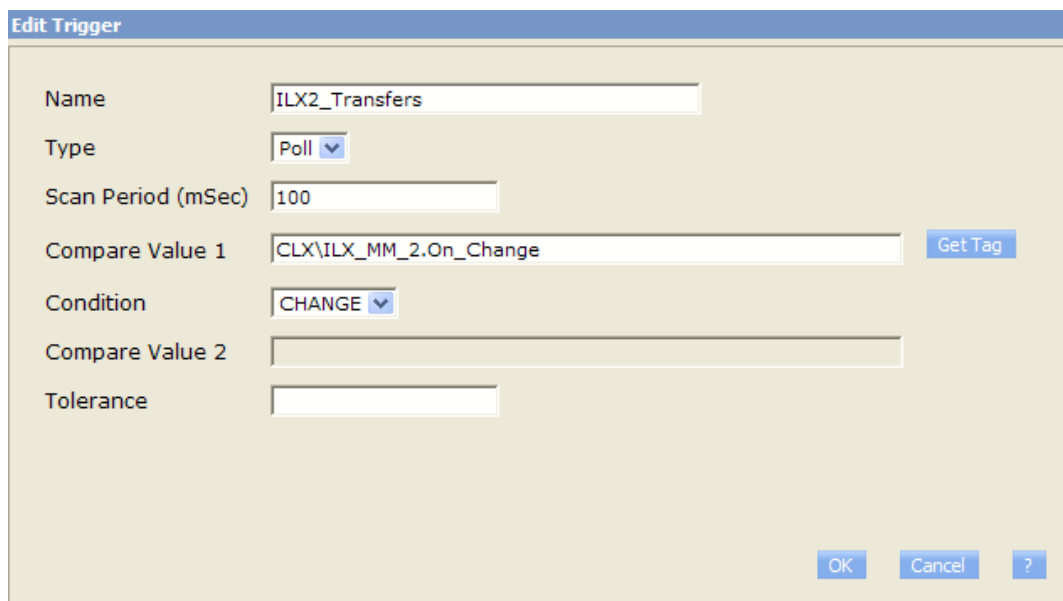

The screenshot shows the 'Edit Trigger' dialog box with the following configuration:

- Name: ILX2\_Transfers
- Type: Poll
- Scan Period (mSec): 100
- Compare Value 1: CLX\ILX\_MM\_2.On\_Change (with a 'Get Tag' button to the right)
- Condition: CHANGE
- Compare Value 2: (empty)
- Tolerance: (empty)

Buttons at the bottom: OK, Cancel, ?

## Example ILX56-MM “Equal” Option Trigger configuration

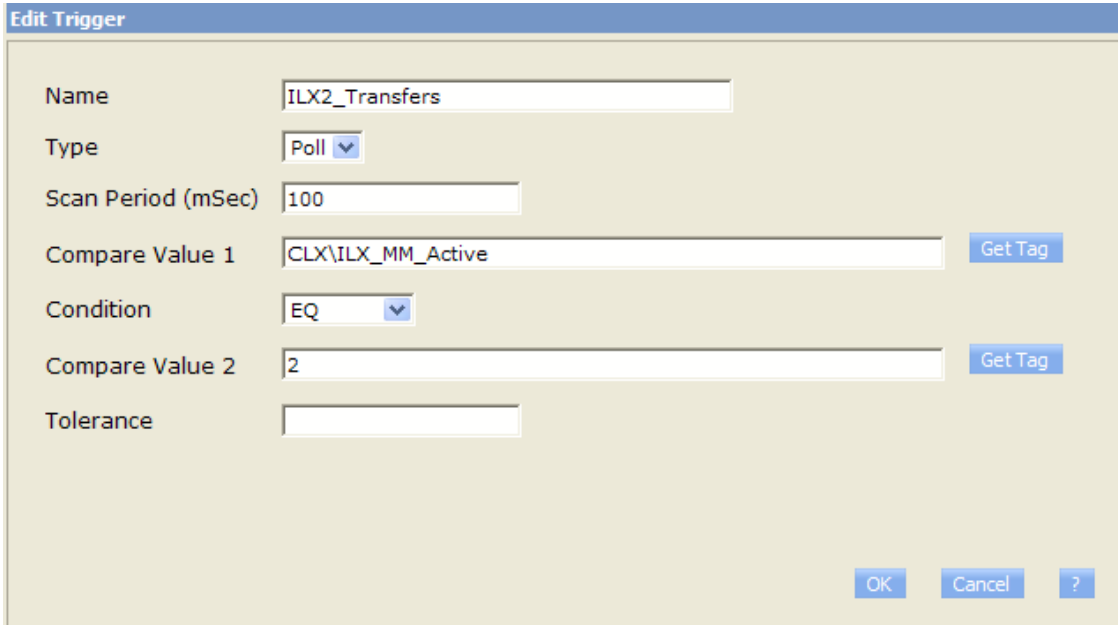

The screenshot shows the 'Edit Trigger' dialog box with the following configuration:

- Name: ILX2\_Transfers
- Type: Poll
- Scan Period (mSec): 100
- Compare Value 1: CLX\ILX\_MM\_Active (with a 'Get Tag' button)
- Condition: EQ
- Compare Value 2: 2 (with a 'Get Tag' button)
- Tolerance: (empty field)

Buttons at the bottom: OK, Cancel, ?

### SETUP

Sample ladder, ProSoft\_ILX56\_MM\_Redundancy\_RevB1.ACD V17, has been developed to assist in using two ILX56-MMs in a redundant mode (primary, secondary). This code needs to be added to your ControlLogix application code and modified to point to your ILX56-MM I/O locations. The ILX56-MM firmware must be Version 1.06 (P0330\_093 P: v1.00) or later.

The Sample ladder supplies several diagnostic features including an ILX\_MM\_1.Failure or ILX\_MM\_2.Failure flag, a counter of how many swaps occurred, an ILX\_MM\_1.Error bit to identify an error from any device not communicating to the ILX56-MM and which ILX56-MM is being used. It also contains a Date Time record of the first 10 times the swaps occurred for each module.

The optional Start\_Reset Ladder is used to initialize the diagnostic registers. This can be triggered from the main routine by toggling the Main\_Start\_reset bit.

Configure the first ILX56-MM using Internet Explorer including the data transfers you require using the Trigger option you select. Back-up the ILX56-MM configuration and then restore it to the second ILX56-MM. The Ethernet IP address(s) will need to be changed. The trigger will need to be pointed to the appropriate tag if the “Change” trigger option is used.

Put the ILX56-MMs in the “Run” mode and then put the ControlLogix in the “Run” mode and then test your system.

## Example ILX56-MM Configuration showing the Modbus TCP/IP Transfer

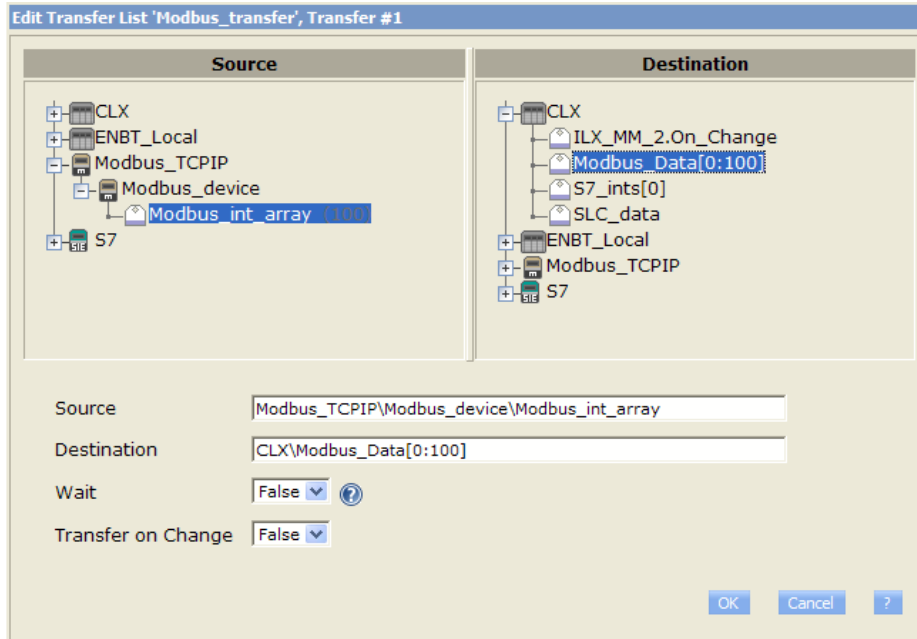

## Example code ControlLogix Controller Tags

Name	Value	Data Type	Description
Ex_Failure_count1_les_10	0	INT	Used to limit How many wall clock values are saved. First 10 ILX1
Ex_Failure_count2_les_10	0	INT	Used to limit How many wall clock values are saved. First 10 ILX1
Example_Failure_count_1	{...}	COUNTER	How many times the module has swapped since last time manually set to 0
Example_Failure_count_2	{...}	COUNTER	How many times the module has swapped since last time manually set to 0
ILX_Main_timer	{...}	TIMER	ILX56-MM health check rate
ILX_MM_1	{...}	ILX_MM	ILX56-MM Status UDT
ILX_MM_1.Activity_counter	6972019	DINT	ILX56-MM Status UDT
ILX_MM_1.Activity_counter_old	6972009	DINT	ILX56-MM Status UDT
ILX_MM_1.On_Change	25193	INT	ILX56-MM Status UDT
ILX_MM_1.Switch	0	BOOL	ILX56-MM Status UDT
ILX_MM_1.RunMode_In	1	BOOL	ILX56-MM Status UDT
ILX_MM_1.IdleMode_in	0	BOOL	ILX56-MM Status UDT
ILX_MM_1.Mode_out	2	DINT	ILX56-MM Status UDT
ILX_MM_1.Mode_change	55	DINT	ILX56-MM Status UDT
ILX_MM_1.Error	0	BOOL	ILX56-MM Status UDT
ILX_MM_1.Failure	0	BOOL	ILX56-MM Status UDT
ILX_MM_2	{...}	ILX_MM	ILX56-MM Status UDT
ILX_MM_Active	1	INT	Which ILX56-MM is being used.
Keep_alive	{...}	TIMER	Secondary ILX56-MM network device connection time out
Local:3:C	{...}	AB:1756_MODULE:C:0	
Local:3:I	{...}	AB:1756_MODULE_DINT_8Bytes:I:0	
Local:3:O	{...}	AB:1756_MODULE_DINT_8Bytes:O:0	
Local:5:C	{...}	AB:1756_MODULE:C:0	
Local:5:I	{...}	AB:1756_MODULE_DINT_8Bytes:I:0	
Local:5:O	{...}	AB:1756_MODULE_DINT_8Bytes:O:0	
Main_Start_reset	0	BOOL	Used to clear all failures, wall clock times, and make sure ILX56-MM's are in Run mode
Modbus_Data	{...}	INT[1000]	Tags for Modbus TCP/IP device data
S7_ints	{...}	INT[100]	Tags for Siemens device data
SLC_data	{...}	INT[100]	Tags for SLC 5/05 data
Start_counter	78	INT	Creates a changing value to allow the ladder to turn on the run modes for Start_Reset ladder
Time_of_ILX1_last_fail	{...}	DINT[100]	Wall Clock Time Last 10 times logic switch away from ILX1
Time_of_ILX2_last_fail	{...}	DINT[100]	Wall Clock Time Last 10 times logic switch away from ILX2

## Tag Descriptions: (x = ILX56-MM 1 or 2)

Ex_Failure_countx_les_10:	Used to limit How many wall clock values are saved. First 10 ILXx
Example_Failure_count_x:	How many times the module has swapped since last time manually set to 0
ILX_Main_timer:	How often to check the health of the ILX56-MMs
ILX_MM_x	
ILX_MM_x.Activity_counter:	ILX56-MM free running counter
ILX_MM_x.Activity_counter_old:	Shows last value of Activity Counter
ILX_MM_x.On_Change:	Checks to make sure the PAC/PLC is in run mode as well as which ILX56-MM should be polling the PAC/PLCs
ILX_MM_1.Switch	This bit forces a switch over when the ILXx has failed
ILX_MM_x.RunMode_In:	1 = Module in Run Mode
ILX_MM_x.IdleMode_in:	1 = Idle Mode
ILX_MM_x.Mode_out:	1= IdleMode 2=RunMode Requires change in Mode_change to make take effect
ILX_MM_x.Mode_change:	Change makes Mode_out take effect
ILX_MM_x.Error:	1 = Port Error in ILX
ILX_MM_x.Failure:	Problem occurred for Error_timer duration
ILX_MM_Active:	Which ILX is being used.
Main_Start_reset:	Used to clear all failures, wall clock times, and make sure ILX's are in Run mode
Modbus_Data:	Data Received from ILX56-MMs
S7_ints:	Data Received from ILX56-MMs
SLC_data:	Data Received from ILX56-MMs
Start_counter:	Creates a changing value to allow the ladder to turn on the run modes for Start_Reset ladder
Time_of_ILXx_last_fail:	Wall Clock Time Last 10 times logic switch away from ILXx

## Timing Considerations

This test case the data exchange is setup for 100 ms triggering. It took 40 ms average (36-59 ms range) for the 100 Modbus Integers to get transferred.

**\*\*For every command to a specific IP address (end device) all transfers should be added together to determine the fastest trigger speed. Separate IP addresses will have separate connections so use the longest one device being communicated too, plus some over head safety time. The RPI of the ILX56-MM's is set to 25 ms in this example. More than two RPI cycles are required to monitor a change in the free running timer of the ILX56-MM. This example uses 150 ms for the main timer preset value and is the minimum setting. You may need to increase this value if you ILX56-MM are in remote racks from the ControlLogix processor.**

Setting the Trigger poll rate faster than a transfer's "Exe Max" should NOT be done.

## ILX56-MM Trigger Status

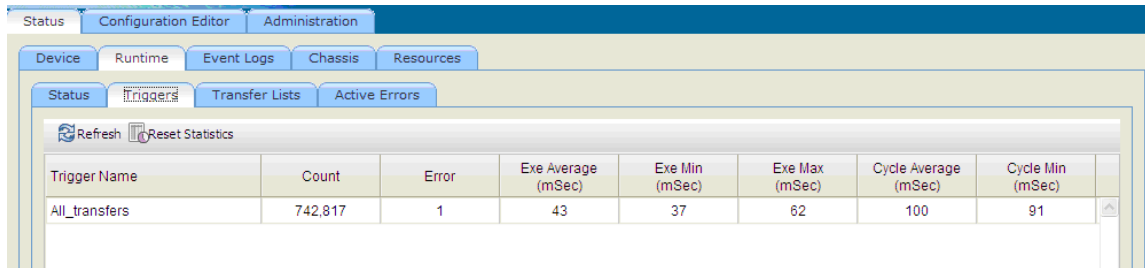

Trigger Name	Count	Error	Exe Average (mSec)	Exe Min (mSec)	Exe Max (mSec)	Cycle Average (mSec)	Cycle Min (mSec)
All_transfers	742,817	1	43	37	62	100	91

## Generic Profile Configuration

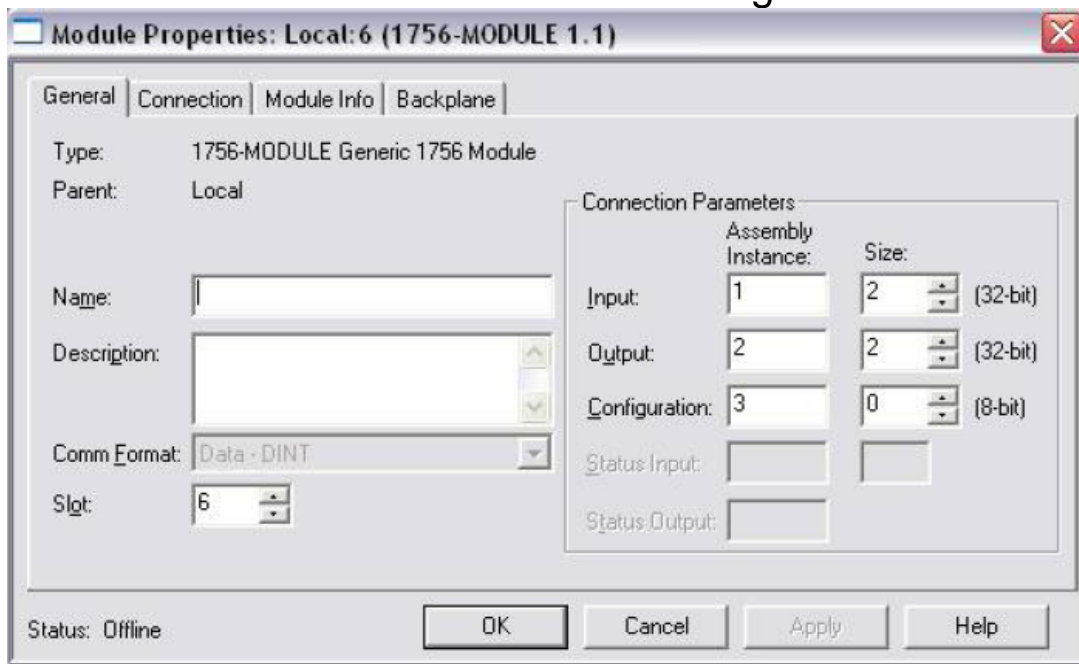

**Module Properties: Local:6 (1756-MODULE 1.1)**

General | Connection | Module Info | Backplane

Type: 1756-MODULE Generic 1756 Module  
Parent: Local

Name:

Description:

Comm Format: Data - DINT

Slot: 6

**Connection Parameters:**

	Assembly Instance:	Size:
Input:	1	2 (32-bit)
Output:	2	2 (32-bit)
Configuration:	3	0 (8-bit)
Status Input:		
Status Output:		

Status: Offline

OK Cancel Apply Help

This is how the information is used.

- CLX Output DINT[0] is the command trigger (CmdTrigger)
  - Increment (or change) this in ladder to execute the command contained in DINT[1].
- CLX Output DINT[1] is the command (Cmd).
  - Currently supported commands values are:
    - 1=Go to IdleMode
    - 2=Go to RunMode
- CLX Input DINT[0] is status information.
  - Bit[0] = IdleMode indicator
  - Bit[1] = RunMode indicator
  - Bit[2] = ActiveError indicator
- CLX Input DINT[1] is a FreeRunCounter.



RPI should not be less than 25.0 ms

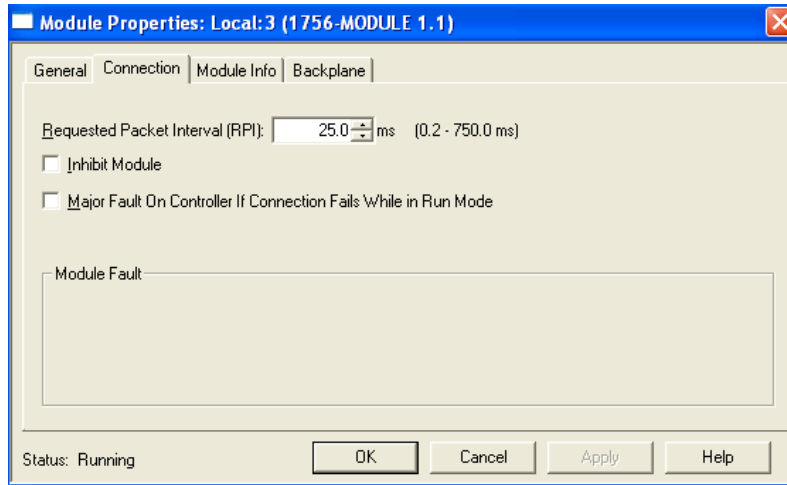

## Code to copy ILX56-MMs Status data to named Controller Tags

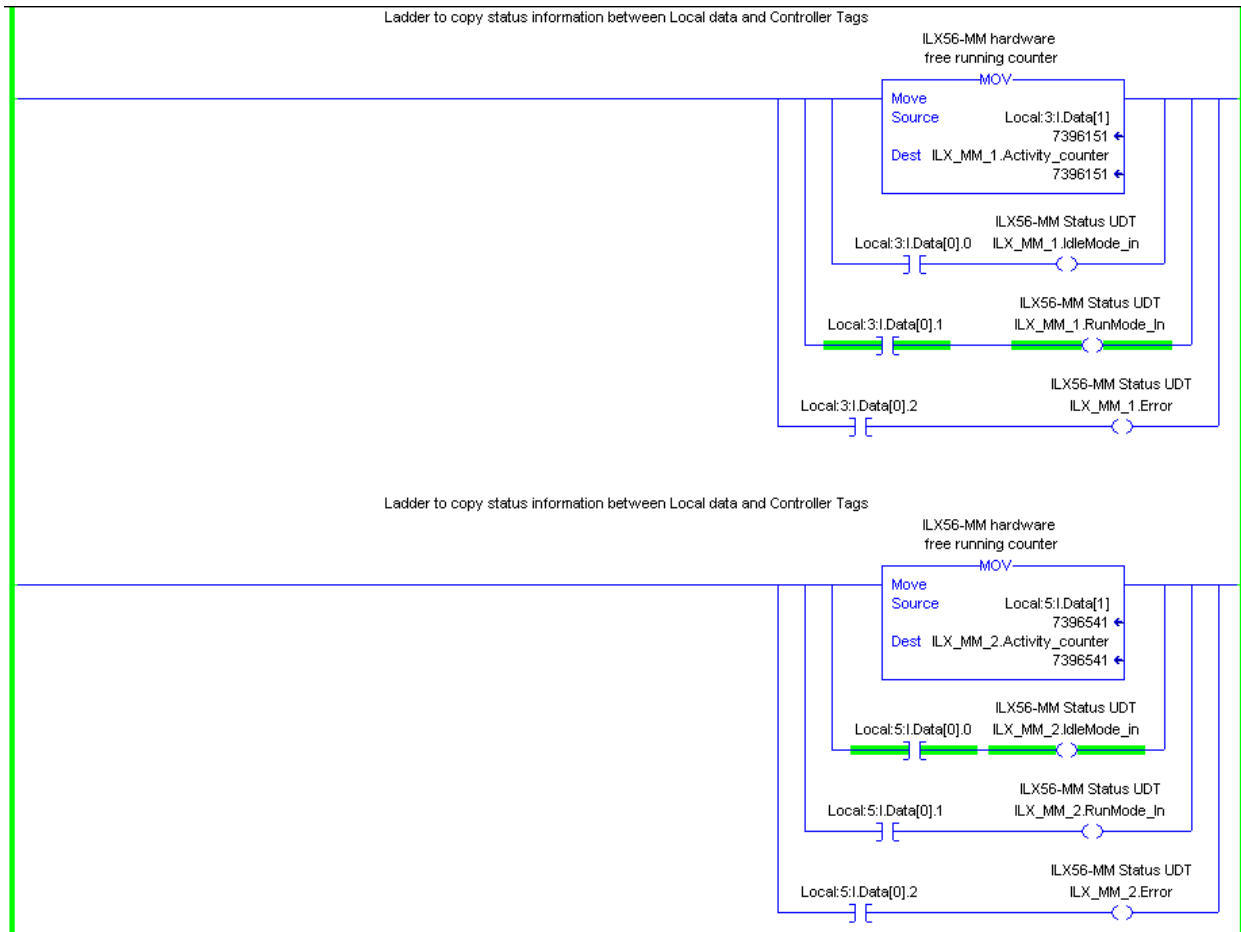

## Code to set how often to check the ILX56-MM's health

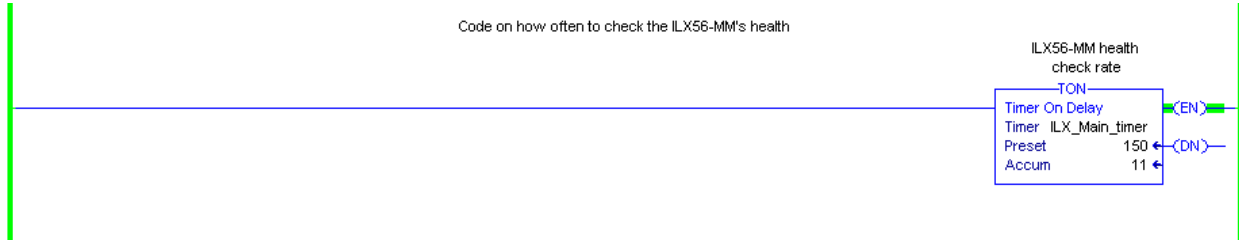

## Code that checks which ILX56-MM is healthy and is running

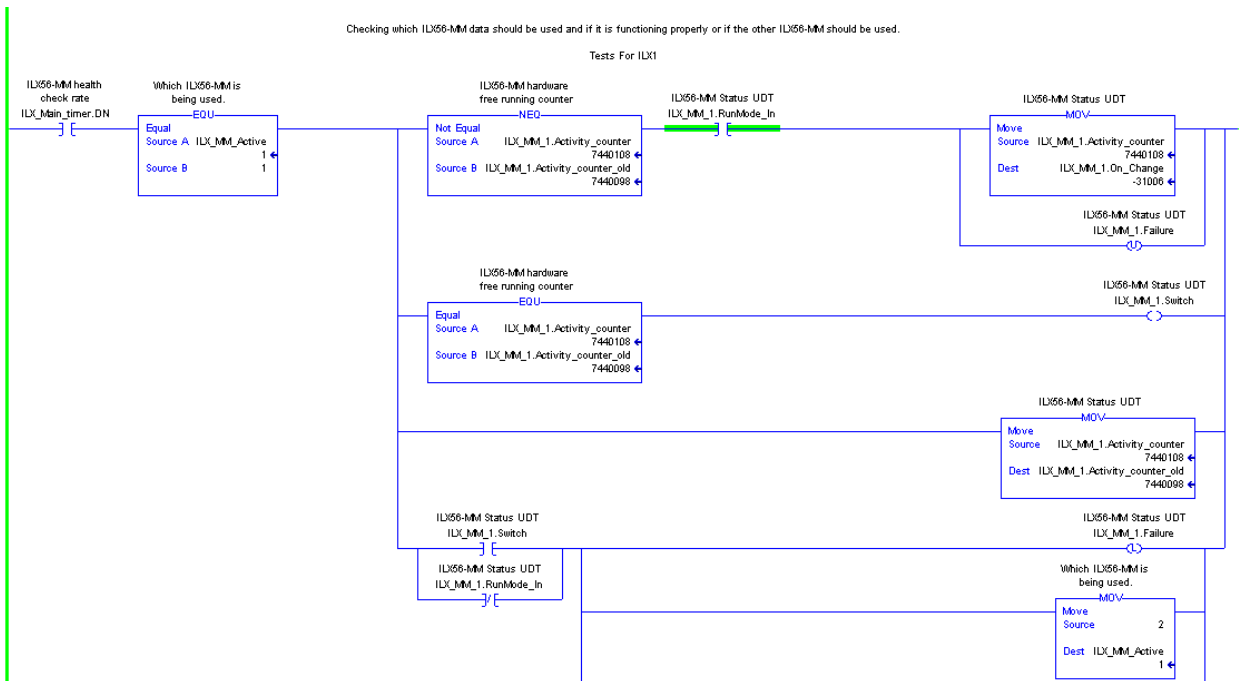

## Code that counts failures and time date stamps the event

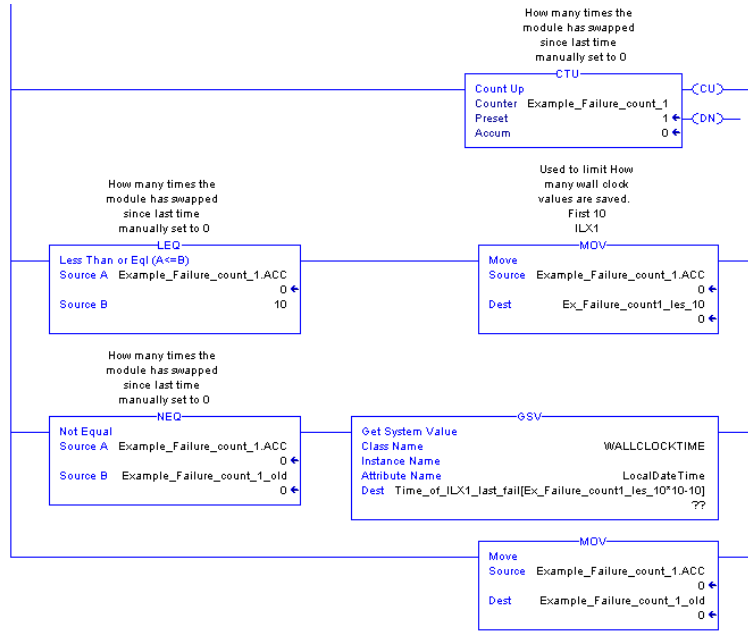

## Code used for PAC setting ILX56-MM to Run or Idle mode

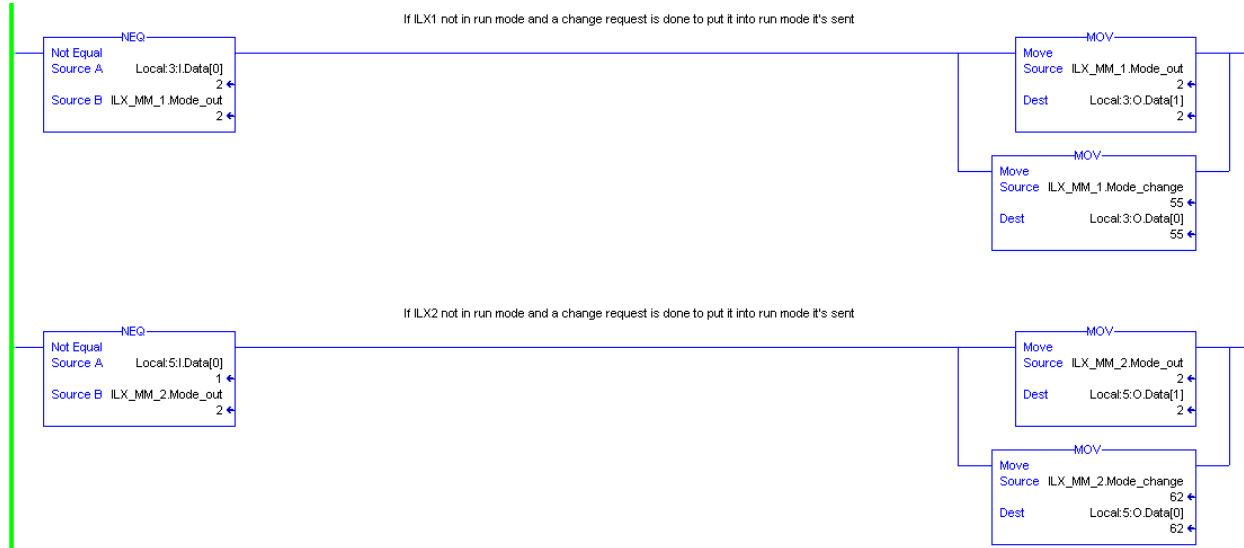

Optional:

## Start Reset Ladder code

Makes sure the ILX56-MMs are in run mode, resets counters in ladder, and clears time stamp history in the controller tags

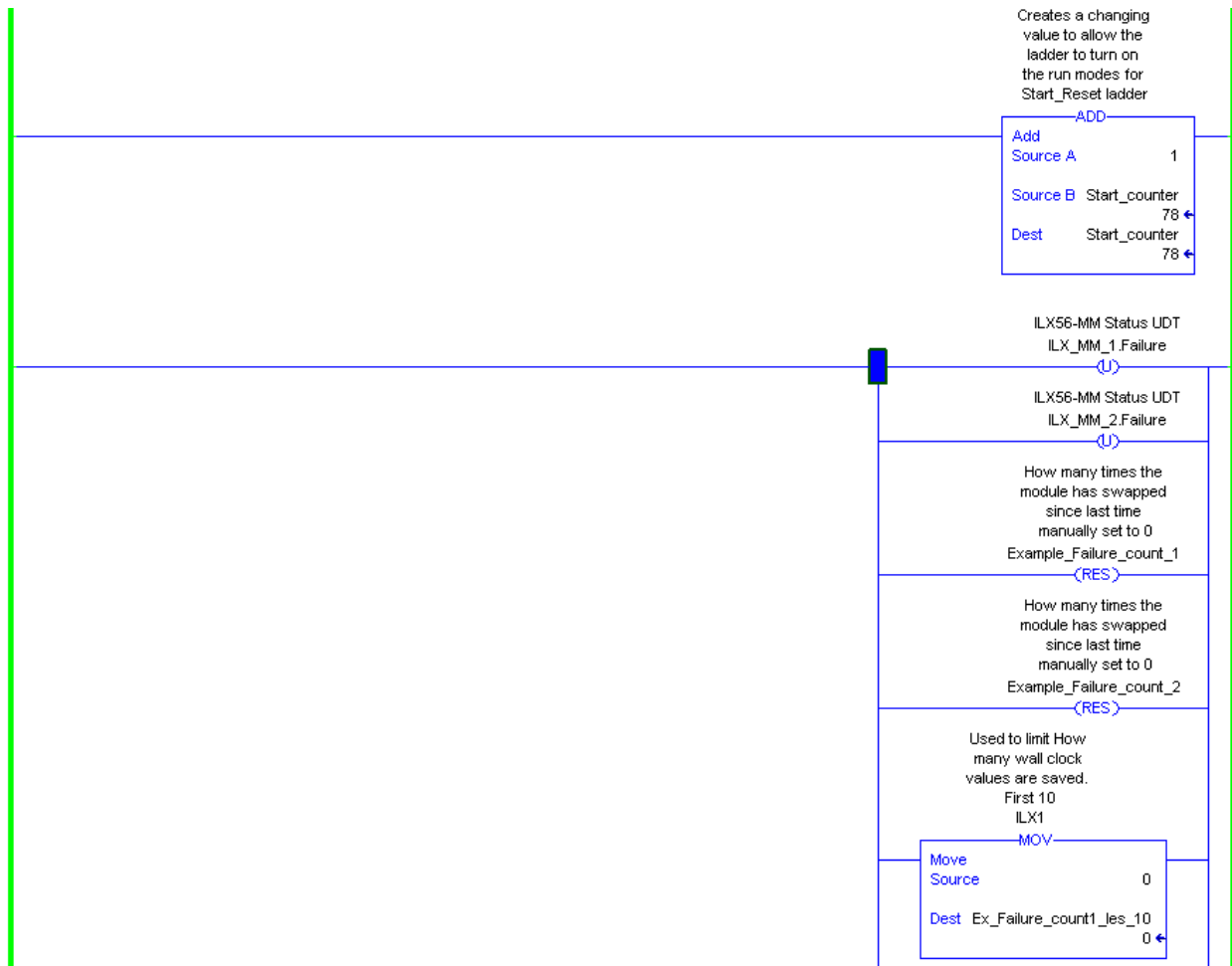

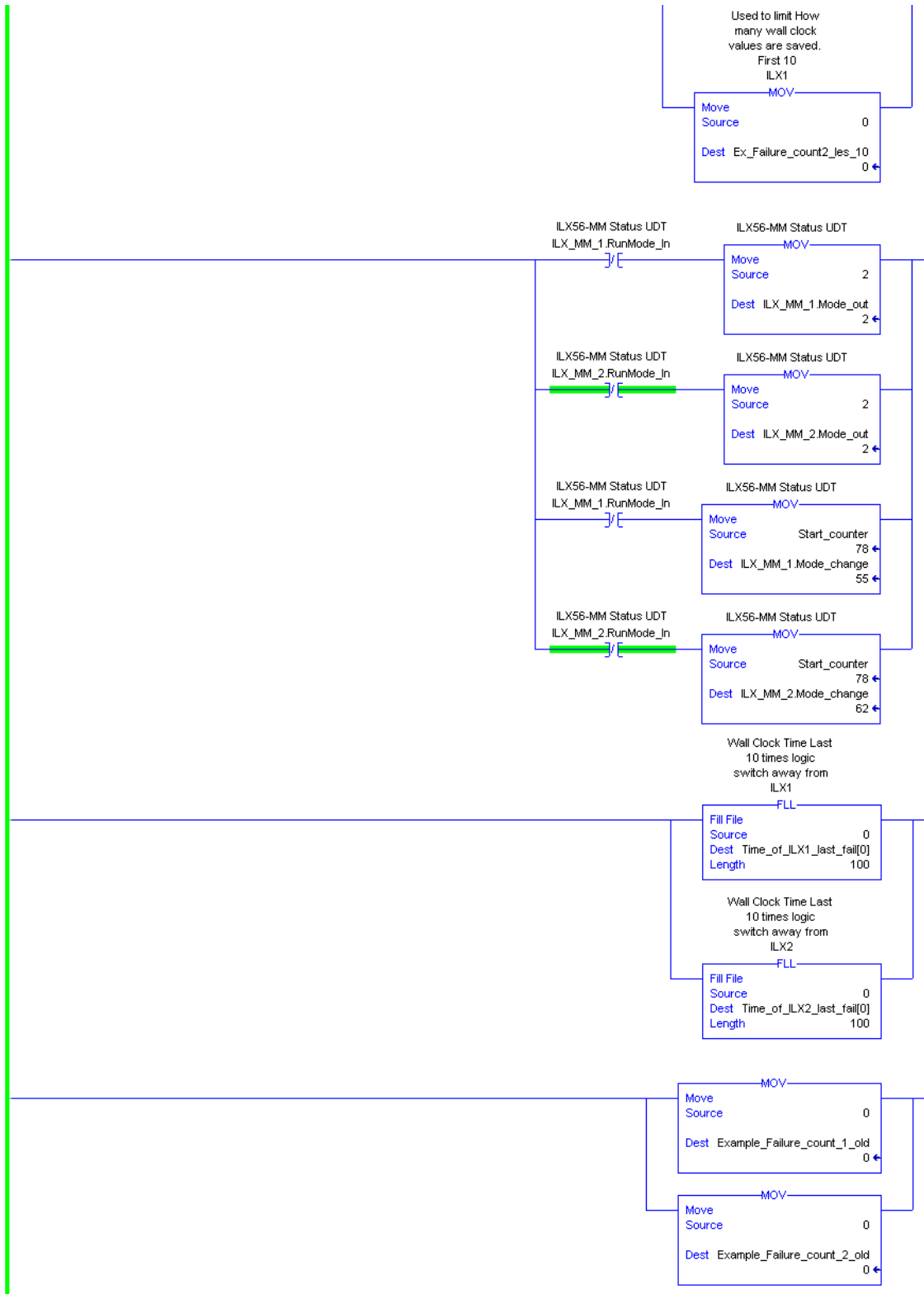

## Asia Pacific

### Malaysia Office

Phone: +603.7724.2080

asiapc@prosoft-technology.com

*Languages spoken: Chinese, English, Japanese*

### China Office

Phone: +86.21.5187.7337

asiapc@prosoft-technology.com

*Languages spoken: Chinese, English*

## Europe

### France Office

Phone: +33 (0)5.34.36.87.20

support.emea@prosoft-technology.com

*Languages spoken: French, English*

### Middle East and Africa

Phone: +971.(0)4.214.6911

mea@prosoft-technology.com

*Languages spoken: English, Hindi*

## North America

### California and Wisconsin Offices

Phone: +1 661.716.5100

support@prosoft-technology.com

*Languages spoken: English, Spanish*

## Latin America

### Brasil Office

Phone: +55.11.5083.3776

brasil@prosoft-technology.com

*Languages spoken: Portuguese, English*

### Mexico and Central America Office

Phone: +52.222.3.99.6565

soporte@prosoft-technology.com

*Languages spoken: Spanish, English*

### Regional Office

Phone: +1.281.298.9109

latinam@prosoft-technology.com

*Languages spoken: Spanish, English*