



PLX82-EIP-61850
Communication Gateway
EtherNet/IP to IEC 61850 Gateway

October 14, 2024

Your Feedback Please

We always want you to feel that you made the right decision to use our products. If you have suggestions, comments, compliments or complaints about our products, documentation, or support, please write or call us.

How to Contact Us

ProSoft Technology, Inc.
+1 (661) 716-5100
+1 (661) 716-5101 (Fax)
www.prosoft-technology.com
support@prosoft-technology.com

PLX82-EIP-61850 User Manual
For public use

October 14, 2024

ProSoft Technology®, is a registered copyright of ProSoft Technology, Inc. All other brand or product names are or may be trademarks of, and are used to identify products and services of, their respective owners.

In an effort to conserve paper, ProSoft Technology no longer includes printed manuals with our product shipments. User Manuals, Datasheets, Sample Ladder Files, and Configuration Files are provided at our website: www.prosoft-technology.com

Content Disclaimer

This documentation is not intended as a substitute for and is not to be used for determining suitability or reliability of these products for specific user applications. It is the duty of any such user or integrator to perform the appropriate and complete risk analysis, evaluation and testing of the products with respect to the relevant specific application or use thereof. Neither ProSoft Technology nor any of its affiliates or subsidiaries shall be responsible or liable for misuse of the information contained herein. Information in this document including illustrations, specifications and dimensions may contain technical inaccuracies or typographical errors. ProSoft Technology makes no warranty or representation as to its accuracy and assumes no liability for and reserves the right to correct such inaccuracies or errors at any time without notice. If you have any suggestions for improvements or amendments or have found errors in this publication, please notify us.

No part of this document may be reproduced in any form or by any means, electronic or mechanical, including photocopying, without express written permission of ProSoft Technology. All pertinent state, regional, and local safety regulations must be observed when installing and using this product. For reasons of safety and to help ensure compliance with documented system data, only the manufacturer should perform repairs to components. When devices are used for applications with technical safety requirements, the relevant instructions must be followed. Failure to use ProSoft Technology software or approved software with our hardware products may result in injury, harm, or improper operating results. Failure to observe this information can result in injury or equipment damage.

Copyright © 2024 ProSoft Technology, Inc. All Rights Reserved.



For professional users in the European Union

If you wish to discard electrical and electronic equipment (EEE), please contact your dealer or supplier for further information.



Warning – Cancer and Reproductive Harm – www.P65Warnings.ca.gov

Important Safety Information

Power, Input, and Output (I/O) wiring must be in accordance with Class I, Division 2 wiring methods, Article 501-4 (b) of the National Electrical Code, NFPA 70 for installation in the U.S., or as specified in Section 18-1J2 of the Canadian Electrical Code for installations in Canada, and in accordance with the authority having jurisdiction. The following warnings must be heeded:

North America Warnings

- A** Warning - Explosion Hazard - Substitution of components may impair suitability for Class I, Division 2.
- B** Warning - Explosion Hazard - When in Hazardous Locations, turn off power before replacing or rewiring modules.
- C** Warning - Explosion Hazard - Do not disconnect equipment unless power has been switched off or the area is known to be nonhazardous.

Agency Approvals and Certifications

Please visit our website: www.prosoft-technology.com

Contents

Your Feedback Please	2
How to Contact Us.....	2
Content Disclaimer	2
Important Safety Information	3
1 Start Here	7
1.1 Overview	7
1.2 System Requirements	8
1.3 Deployment Checklist	8
1.4 Package Contents	9
1.5 Setting Jumpers	9
1.6 Mounting the PLX82-EIP-61850 on a DIN-rail.....	10
1.7 Connecting Power to the Unit	10
1.8 Installing ProSoft Software	11
1.8.1 Installing the ProSoft Discovery Service.....	11
1.8.2 Installing the ProSoft EIP-61850 Configuration Manager.....	11
1.8.3 Installing the ProSoft EIP-61850 Tag Monitor	11
2 Configuring the PLX82-EIP-61850 Gateway	12
2.1 Connecting Your PC to the Gateway.....	12
2.2 Setting a Temporary IP Address in the Gateway	12
2.3 Creating a New Project in the Configuration Manager	14
2.4 Importing a Project into the Configuration Manager	16
2.5 Configuring the Gateway EtherNet/IP Adapter	16
2.6 Importing IED Files	18
2.7 Creating the IED Network	21
2.8 Mapping Data Attributes from IEDs to the Gateway	22
2.8.1 Mapping MMS Messages	23
2.8.2 Mapping MMS Write Messages.....	26
2.8.3 Mapping Reports	27
2.8.4 Mapping GOOSE Messages	30
2.8.5 Deleting one or more IEC 61850 mappings	32
2.9 Mapping Tags in the Gateway to EtherNet/IP	33
2.10 Validating the Configuration.....	36
2.11 Downloading the Configuration File to the Gateway	37
2.12 Uploading the Configuration from the Gateway.....	38
2.13 Exporting the IED Add-On Instructions for RSLogix 5000.....	39
2.14 Exporting a Project from the Configuration Manager	40
2.15 Importing Updated IED Files.....	40
3 Configuring the EtherNet/IP Driver	42
3.1 Create or open a project in RSLogix 5000	42
3.2 Adding an Ethernet Bridge.....	43
3.3 Adding the Gateway	45
3.4 Download the project to the processor to verify the connection.....	49
3.5 Import the AOI from the Configuration Manager	50
3.6 Adding the Rung to Your Project	52
3.7 Mapping to the Generic Ethernet Bridge	54

3.8	Importing an updated AOI from an updated IED	56
3.9	Configuring Class 3 MSG Instructions	57
3.9.1	CIP Data Table Write	58
3.9.2	CIP Generic Get Attribute Single	60
3.9.3	CIP Generic Set Attribute Single	61
4	Diagnostics and Troubleshooting	62
4.1	Known Anomalies	62
4.2	Important Design Considerations	62
4.3	Driver Status Data	63
4.3.1	Status Values	64
4.4	Rebooting the Gateway	66
4.5	ProSoft EIP-61850 Tag Monitor Diagnostics	67
4.6	ProSoft 61850 Configuration Manager Diagnostics	68
4.6.1	IEC 61850 Client Diagnostics	68
4.6.2	MCP Diagnostics	73
4.6.3	EtherNet/IP Diagnostics	75
4.6.4	SNTP/NTP	76
4.7	Web Service and Gateway Webpage	77
4.8	Event Logger	79
4.8.1	61850C Events	80
4.8.2	EIPS Events	80
4.8.3	MCP Events	81
4.8.4	MCP Interface Events	81
4.8.5	SNTP/NTP Events	81
4.8.6	InterProcess Communication (IPC) Events	82
5	Reference	83
5.1	Specifications	83
5.1.1	Module	83
5.1.2	EtherNet/IP (EIP)	83
5.1.3	IEC 61850 Client	84
5.1.4	SNTP/NTP Client	84
5.2	Hardware Specifications	85
5.3	LEDs	86
5.3.1	Module LEDs	86
5.3.2	Ethernet Port LEDs	86
5.4	Gateway Specifications	87
5.4.1	Asynchronous Processes	87
5.4.2	Tag Database	88
5.4.3	SNTP/NTP	89
5.5	IEC 61850 Specifications	90
5.5.1	Application Association Model	90
5.5.2	DATA-SET	93
5.5.3	Report Control Block	93
5.5.4	GOOSE Control Block	97
5.5.5	Control	99
5.5.6	MMS	103
5.5.7	EtherNet/IP Adapter	107
5.5.8	IEC 61850 Client	108
5.6	IEC 61850 Standard Introduction	109
5.6.1	Integrating the Substation	109

5.6.2	IEC 61850 Benefits	110
5.6.3	IEC 61850 Communication Features	111
5.6.4	SCL / Standardized Data Exchange	111
5.6.5	Advantages to Substation Configuration Description Language (SCL).....	111
5.6.6	Report Control Block BRCB (Clause 14)	113
5.6.7	GSE (Clause 15).....	114
5.6.8	Control (Clause 17).....	114
5.6.9	Naming Conventions (Clause 19).....	120
5.7	Usage Examples.....	121
5.7.1	Rockwell Automation PLC Device Configuration.....	121
5.7.2	Energy Application	123
5.7.3	Monitoring	124
5.7.4	Measuring and Metering	124
5.7.5	Supervision and Protection	124
6	List of Abbreviations	125

7	Support, Service & Warranty	140
7.1	Contacting Technical Support.....	140
7.2	Warranty Information	140

1 Start Here

To get the most benefit from this User Manual, you should have the following skills:

- **Rockwell Automation® RSLogix™ software:** launch the program, configure ladder logic, and transfer the ladder logic to the processor
- **Microsoft Windows®:** install and launch programs, execute menu commands, navigate dialog boxes, and enter data
- **Hardware installation and wiring:** install the module, and safely connect EIP-61850 and ControlLogix or CompactLogix devices to a power source and to the PLX82-EIP-61850 gateway's Ethernet port
- **Intelligent Electronic Device (IED):** have one or more IEDs and be familiar with the IED configuration software

1.1 Overview

This User Manual explains the features of the PLX82-EIP-61850 EtherNet/IP to IEC 61850 gateway. It guides you through configuring the gateway, showing how to map IEC 61850 Data Attributes between an Intelligent Electronic Device (IED) and a Rockwell Automation® ControlLogix® or CompactLogix™ (PLC). The ProSoft EIP-61850 Configuration Manager software creates files to import into RSLogix™ 5000 programming software, integrating the gateway into your system.

This document provides examples of how to move IEC 61850 Data Attributes using IEC 61850 8.1 MMS messages. The PLC reads and writes data to the IED. The gateway uses Class 1 EtherNet/IP I/O messaging to send data from the IEDs to the Logix processor.

IEDs are generally supplied with their own configuration software, and a template IED Capability Description (ICD) file. The template file represents a device that is not configured. Once configured, the device makes a Configured IED Description (CID) file. Some devices can also make a System Configuration Description (SCD) file. Some IEDs generate an ICD file (rather than a CID file) for their configured file. You must have these files on hand before beginning this process.

PLX82-EIP-61850 gateways with firmware version v2.002 and above support the Link Layer Discovery Protocol (LLDP). For a complete list of features and supported functions of the PLX82-EIP-61850 gateway, refer to the IEC 61850 PICS Statement, available as a separate download at: www.prosoft-technology.com.

1.2 System Requirements

The PLX82-EIP-61850 module requires the following minimum hardware and software components:

- Rockwell Automation ControlLogix or CompactLogix processor (firmware version 10 or higher).
- Rockwell Automation RSLogix 5000 programming software version 16 or higher
- Rockwell Automation RSLinx® communication software version 2.51 or higher.

The ProSoft EIP-61850 Configuration Manager configuration software for the PLX82-EIP-61850 gateway requires the following minimum hardware and software components:

- Pentium® II 450 MHz minimum. Pentium III 733 MHz (or better) recommended
- 128 Mbytes of RAM minimum, 256 Mbytes of RAM recommended
- 100 Mbytes of free hard disk space (or more based on application requirements)

Supported operating systems:

- Microsoft Windows 10
- Microsoft Windows 7 (32 or 64-bit)
- Microsoft Windows 2000 Professional with Service Pack 1, 2, or 3
- Microsoft Windows Server 2003

ProSoft fdt Configuration Manager requires that Microsoft .NET be installed on the PC or laptop used to configure the gateway.

1.3 Deployment Checklist

Before you begin to configure the module, consider the following questions. Your answers will help you determine the scope of your project, and the configuration requirements for a successful deployment.

- Are the RSLogix 5000 and RSLinx software installed?
RSLogix and RSLinx are required to communicate to the ControlLogix or CompactLogix.
- Do you have the Intelligent Electronic Devices (IEDs) and their configuration files?

1.4 Package Contents

The following components are included with your PLX82-EIP-61850 gateway, and are all required for installation and configuration.

Important: Before beginning the installation, verify that all of the following items are present.

Qty.	Part Name	Part Number	Part Description
1	EtherNet/IP to IEC 61850 gateway	PLX82-EIP-61850	ProSoft communication gateway
1	Screwdriver	HRD250	Small, flat-bladed screwdriver
1	Power Connector	J180	3-wire DC power connector

If any of these components are missing, please contact ProSoft Technology Technical Support for replacement parts.

1.5 Setting Jumpers

Jumper settings are located on the back of the module. For security reasons, the Mode 1 and Mode 2 jumpers are not readily accessible. Under normal conditions, these two jumpers will not be needed. The following diagram illustrates the available Setup Jumper setting.

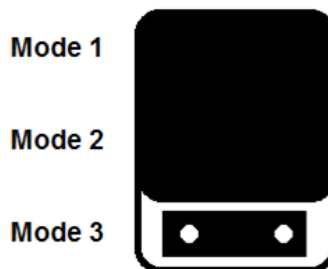

Setup Jumper:

Mode 3 is jumpered by default. It must be jumpered when performing a firmware upgrade or when downloading a configuration file to the module.

For normal operation, this jumper should be hung on only one pin (not jumpered). This allows for better communications between the IEC 61850 and EtherNet/IP drivers.

1.6 Mounting the PLX82-EIP-61850 on a DIN-rail

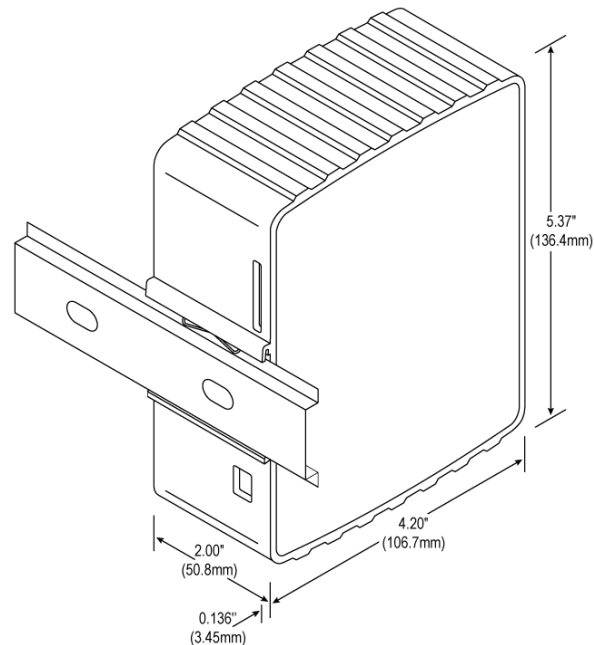

- 1 Position the PLX82-EIP-61850 on the DIN-rail B at a slight angle.
- 2 Hook the lip on the rear of the adapter onto the top of the DIN-rail, and rotate the adapter onto the rail.
- 3 Press the adapter down onto the DIN-rail until flush. The locking tab snaps into position and locks the module to the DIN-rail.
- 4 If the adapter does not lock in place, use a screwdriver or similar device to move the locking tab down while pressing the adapter flush onto the DIN-rail and release the locking tab to lock the adapter in place. If necessary, push up on the locking tab to lock.

1.7 Connecting Power to the Unit

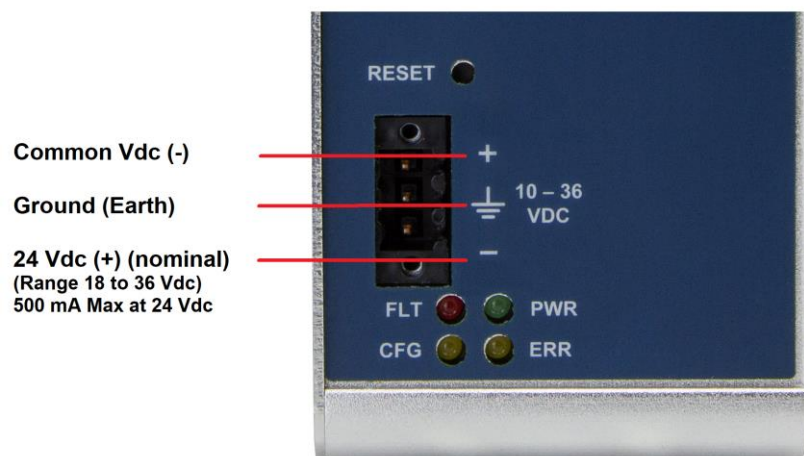

1.8 Installing ProSoft Software

1.8.1 Installing the ProSoft Discovery Service

ProSoft Discovery Service (PDS) is a Windows-based software program that connects to the gateway through the Ethernet port for the following purposes:

- Automatically discovering the gateway on the Ethernet network.
- Setting a temporary IP address for the gateway for commissioning.
- Allowing PDS to select the gateway for monitoring and IP address reconfiguration.

This software is supplied as a stand-alone utility, available from <http://www.prosoft-technology.com>. To install the PDS, follow these steps:

- 1 Navigate to **Products > ProSoft Software**.
- 2 Scroll through the list to locate ProSoft Discovery Service.
- 3 Choose **PROSOFT DISCOVERY SERVICE** to install.

1.8.2 Installing the ProSoft EIP-61850 Configuration Manager

Use the ProSoft EIP-61850 Configuration Manager to configure the gateway. You can find the ProSoft EIP-61850 Configuration Manager at: www.prosoft-technology.com

- 1 Navigate to your PLX82-EIP-61850 product.
- 2 Choose **PROSOFT EIP-61850 CONFIGURATION MANAGER** to install.

Note: To use the ProSoft EIP-61850 Configuration Manager under the Windows 7 (or Windows 10) OS, you must be sure to install it using the *Run as Administrator* option. To find this option, right-click the Setup.exe program icon, and then click **RUN AS ADMINISTRATOR** on the context menu. You must install using this option even if you are already logged in as an Administrator on your network or personal computer (PC). Using the Run as Administrator option allows the installation program to create folders and files on your PC with proper permissions and security. If you do not use the Run as Administrator option, the ProSoft EIP-61850 Configuration Manager may appear to install correctly, but you will receive multiple file access errors whenever the ProSoft EIP-61850 Configuration Manager is running, especially when changing configuration screens. If this happens, you must completely uninstall the ProSoft EIP-61850 Configuration Manager and then re-install using the Run as Administrator option to eliminate the errors.

1.8.3 Installing the ProSoft EIP-61850 Tag Monitor

Use the ProSoft EIP-61850 Tag Monitor to monitor the data tag values through the gateway. It is automatically installed when you install the ProSoft EIP-61850 Configuration Manager.

2 Configuring the PLX82-EIP-61850 Gateway

To configure the PLX82-EIP-61850 gateway, follow these topics in the order as they appear.

You must import the Intelligent Electronic Device (IED) files before you configure the EtherNet/IP device so that the ProSoft EIP-61850 Configuration Manager can help with the EtherNet/IP configuration after you set up the IEDs in the ProSoft EIP-61850 Configuration Manager.

2.1 Connecting Your PC to the Gateway

This gateway has two Ethernet ports, refer to sections Setting a Temporary IP Address in the Gateway (page 12) through Configuring the Gateway EtherNet/IP Adapter (page 16). Later, you can use a patch cable to connect the gateway to a switch, allowing the IEDs, gateway, and ControlLogix or CompactLogix PLC or PAC to all operate on the same network.

Use the ProSoft Discovery Service to locate the gateway and assign a temporary IP address. See Setting a Temporary IP Address in the Gateway (page 12). You can set a permanent IP address when you configure the module. See Configuring the Gateway EtherNet/IP Adapter (page 16).

2.2 Setting a Temporary IP Address in the Gateway

Important: ProSoft Discovery Service (PDS) locates the gateway through UDP broadcast messages. These messages may be blocked by routers or layer 3 switches. In that case, PDS is unable to locate the gateways.

To use PDS, arrange the Ethernet connection so that there is no router or layer 3 switch between the computer and the gateway OR reconfigure the router or layer 3 switch to allow the routing of the UDP broadcast messages.

- 1 In PDS, click the Windows **START** button, and then choose **PROGRAMS > PROSOFT TECHNOLOGY > PROSOFT DISCOVERY SERVICE**.
- 2 Right-click module, and then click **ASSIGN TEMPORARY IP**.

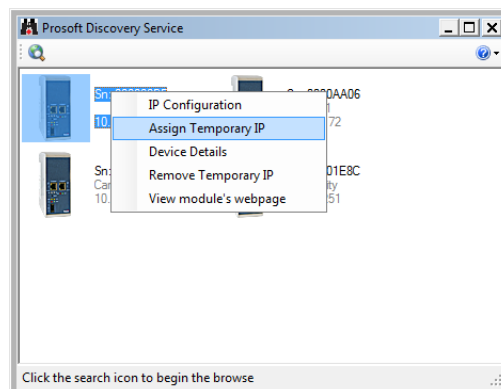

- 3 The module's default IP address is 192.168.0.250.

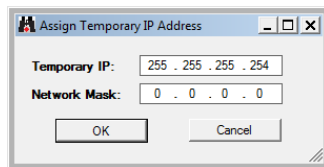

- 4 Enter an unused IP within your subnet, and then click **OK**.
- 5 See Configuring the Ethernet Port for the steps to set the permanent IP address in the gateway.

2.3 Creating a New Project in the Configuration Manager

You configure the gateway with the ProSoft EIP-61850 Configuration Manager software. The first step is creating a project for the gateway.

- 1 If you have not installed the ProSoft EIP-61850 Configuration Manager, refer to Installing the ProSoft EIP-61850 Configuration Manager (page 11).
- 2 Click the Windows **START** button, and then choose **PROGRAMS > PROSOFT TECHNOLOGY > PROSOFT EIP-61850 CONFIGURATION MANAGER**.

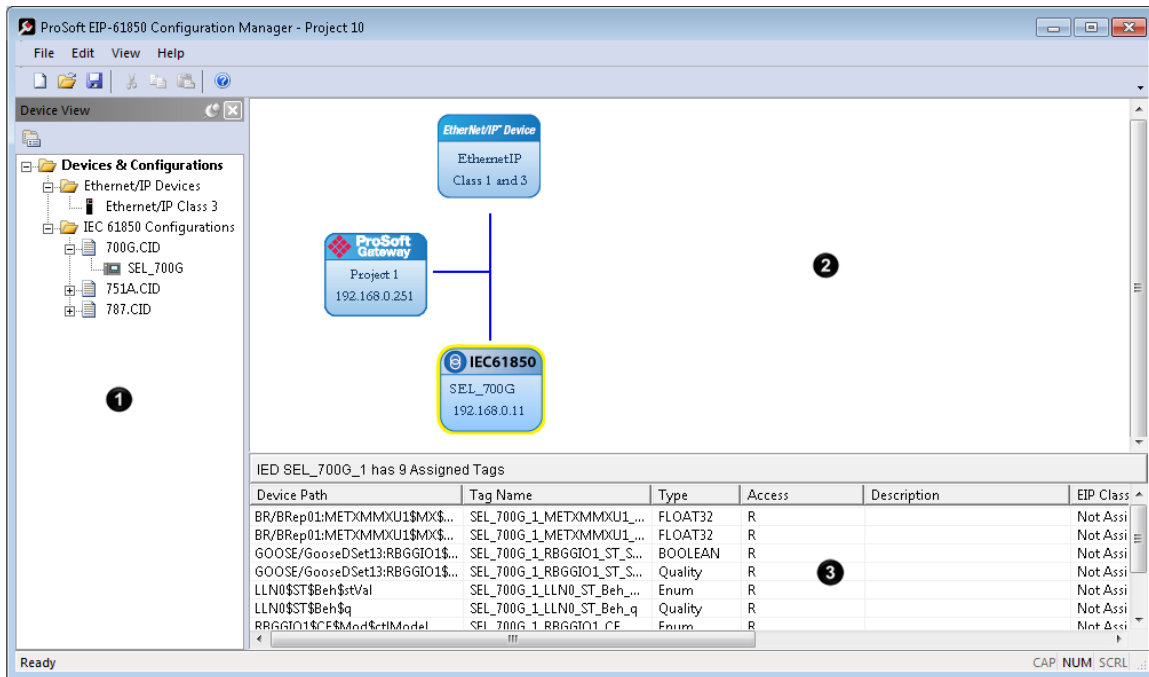

The ProSoft EIP-61850 Configuration Manager window consists three panes:

- 1 *The Device View Tree* shows the EtherNet/IP device and IEC 61850 configurations. The **IEC 61850 Configurations** folder is a list of IED configuration files. This folder is empty until you import IED files.
- 2 *The Network View pane* shows a graphic representation of the devices to be connected to the gateway. Each device appears as a "bubble". **The project bubble (ProSoft Gateway)** represents the gateway itself. **The IED bubbles (IEC61850)** represent the IEC 61850 port on the gateway, and the attached devices. **The EtherNet/IP bubbles (EtherNet/IP Device)** represent both the EtherNet/IP port on the gateway, and the attached Ethernet scanners.
- 3 *The Configured Tags pane* shows the configured tags associated with the currently selected "bubble" in the Network View pane.

When you first start the ProSoft EIP-61850 Configuration Manager, the *Device View* shows default devices and configuration, and the *Network View* shows only the project bubble (*ProSoft Gateway Project 1*).

- 3 Choose **FILE > NEW** to create a new project.
- 4 You can rename the project by right-clicking the project bubble, and then choosing **PROPERTIES**. You can also double-click the project bubble.
- 5 Enter a new name in **PROJECT NAME**, and any notes in **NOTES**, and then click **OK**.
- 6 Save the project by choosing **FILE > SAVE AS** and entering a name for the project.

Note: You need a separate Configuration Manager file for each gateway. You can run multiple instances of the Configuration Manager software at the same time.

Note that the diagram in the *Network View* does not exactly match the physical hardware. In reality, the IED connects to the 61850 side of the gateway, while the EtherNet/IP device connects to the other side. Typically these three devices are connected across a network, rather than connected directly to each other.

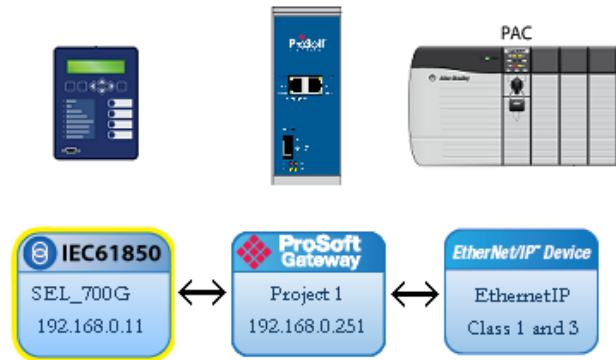

2.4 Importing a Project into the Configuration Manager

You can import a ProSoft EIP-61850 Configuration Manager file that was created and exported on a different PC. Do not try to open a project file created on another PC, because it does not contain all the IED files that were used to create it. Instead, choose **FILE > IMPORT CONFIGURATION**. This recreates all the CID/SCD/ICD files that were part of the original configuration.

If you open a project not created on your PC instead of importing it, the Device View shows a red slash through the IED files.

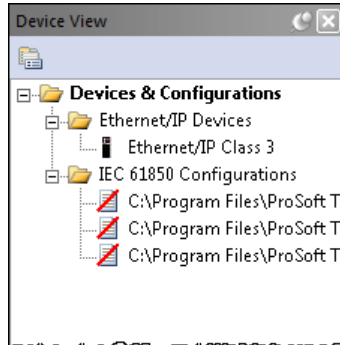

2.5 Configuring the Gateway EtherNet/IP Adapter

Configuring the gateway sets the permanent IP address for the gateway. It also defines the NTP server that the gateway can poll for the current date and time.

Note: The PLX82-EIP-61850 has two physical Ethernet ports – one for each protocol. You must configure these ports on different subnets.

- 1 Right-click the *ProSoft Gateway* bubble and choose **PROPERTIES**. You can also double-click the *ProSoft Gateway* bubble.

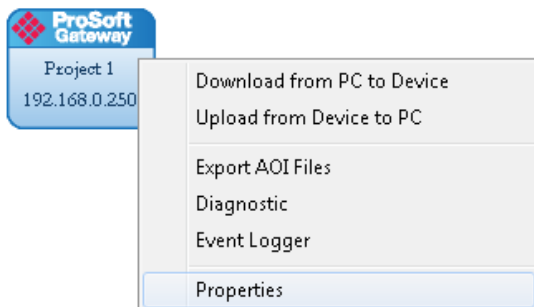

This displays the *ProSoft Gateway Configuration* dialog.

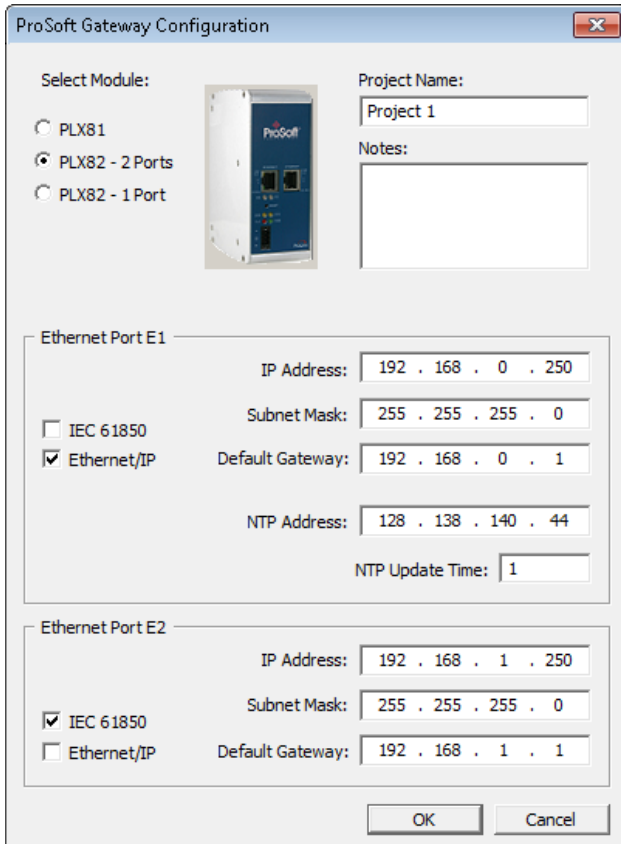

- 2 Choose the correct gateway model (one or two ports).
- 3 Select the function for the port (IEC 61850 or EtherNet/IP). If the gateway has two ports, one must be IEC 61850 and the other EtherNet/IP.
- 4 Enter the IP address and other network information for the gateway port.
 - **IP ADDRESS:** The IP address must be a fixed IP address. Contact your network administrator for assistance.
 - **SUBNET MASK:** Enter the gateway's subnet mask.
 - **IP GATEWAY:** The IP gateway address is optional, and is not required for networks that do not use a default gateway.
- 5 If the gateway has two ports, enter the network information for the second port.
- 6 Enter the **NTP ADDRESS**. The gateway polls the server for the current date and time. For example, in the USA, there are a number of time servers and their IP addresses listed at <http://tf.nist.gov/tf-cgi/servers.cgi>
- 7 Enter the **NTP UPDATE TIME**. This is the polling interval (in minutes) for the current date and time. A value of 0 means the gateway does not poll the NTP server.

2.6 Importing IED Files

After you have configured the gateway in the project, the next step is to import the configured Intelligent Electronic Device (IED) files into the project. IEDs come with a template ICD file, but an ICD file indicates possible configuration options. It usually does not contain specific configuration information. For instance, ICD files usually do not have an IP Address or other configured elements in them. Once an IED has been configured (using third-party configuration software provided by the IED manufacturer), the manufacturer's software usually creates a specific CID configuration file. Some third-party software may also create a SCD system configuration file (an SCD usually has multiple IEDs in it).

Note: You can only import configured ICD, CID, and SCD files. These files must be fully configured and saved in the software that is used to configure the IEDs. The configured file must include the IP address, subnet mask, and gateway address (if required by the network). Also, each IED must have a unique Device Name and IP address.

Note: The IED *Name* of a CID, ICD, or SCD file has a maximum of eight characters.

To import configured IED files:

- 1 In the *Device View* pane of the ProSoft EIP-61850 Configuration Manager, right-click **IEC 61850 CONFIGURATION** and then choose **ADD IED**.

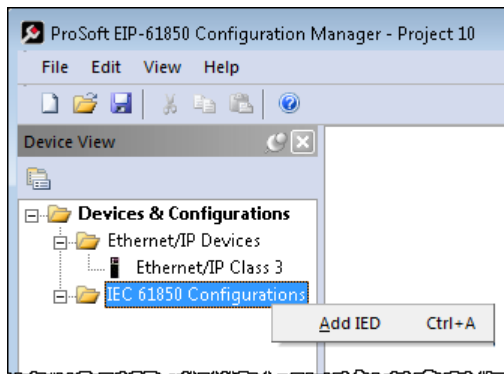

- 2 In the *Open* dialog box, browse to the directory containing the ICD, CID, or SCD file.

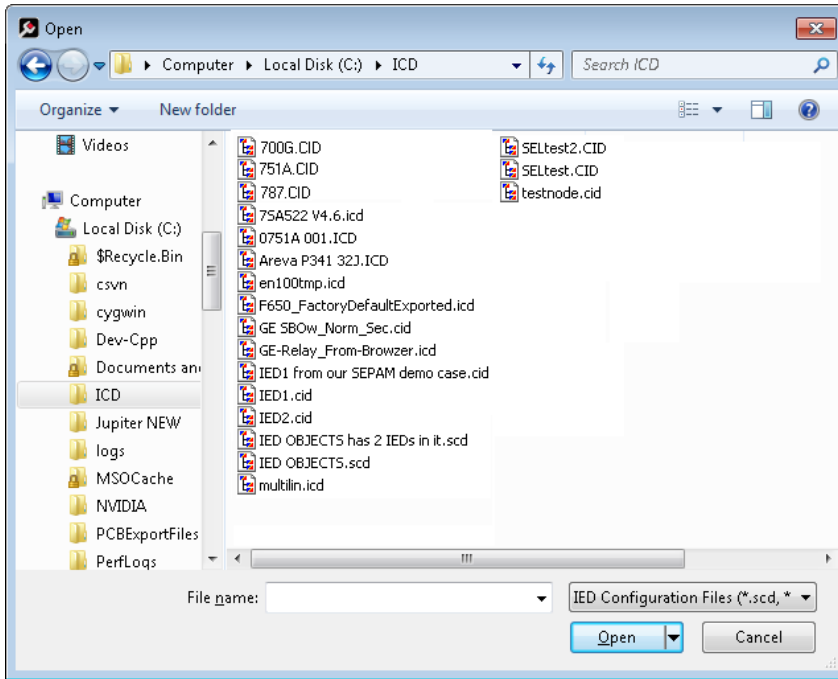

- 3 Make sure the file type is **IED CONFIGURATION FILES (*.SCD, *.ICD, *.CID)**.

Note: The IED name must contain a maximum of 9 characters.

- 4 Each IED has its own configuration file, except for SCD files which can contain more than one IED. Select one or more configuration files to import and click **OPEN**. The imported IED files appear in the *Device View* tree under **IEC 61850 CONFIGURATION**.

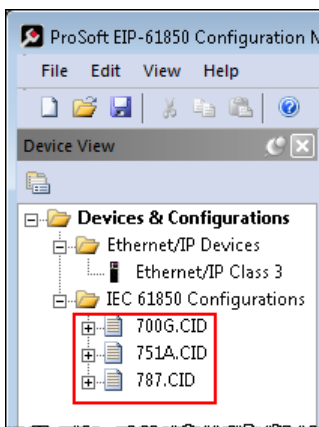

- 5 Repeat the above steps to import the rest of your IED files.

- 6 If you are familiar with the contents of CID, SCD, and ICD files, you can right-click the file name and then choose **DISPLAY** to see the contents of the file in the default text editor.

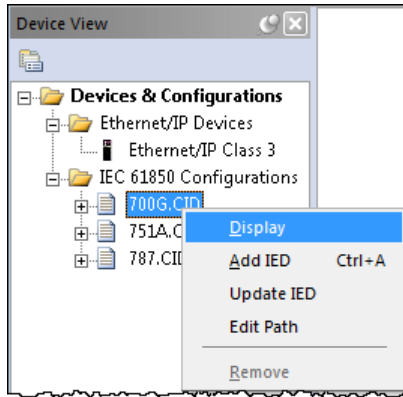

Note: Normally you only view the configuration files in the text editor for reference if you are familiar with these files. If you want to change the IED configuration, use the configuration software for the IED.

2.7 Creating the IED Network

After you have imported the IED files, you can create the IED 61950 network in the ProSoft EIP-61850 Configuration Manager.

To create the IED network configuration:

- 1 In the *Device View* pane of the Configuration Manager, expand the IED file name (700G.CID in this example) by clicking the **[+]** sign next to the file name.
- 2 Click and drag the IED name (*SEL_700G_1* in this example) from the *Device View* pane into the *Network View*. When you release the mouse button, the IED is added to the view in an *IEC 61850* bubble. The bubble shows the IED Device Name and IP address. These values are from the IED file and cannot be changed in the Configuration Manager.

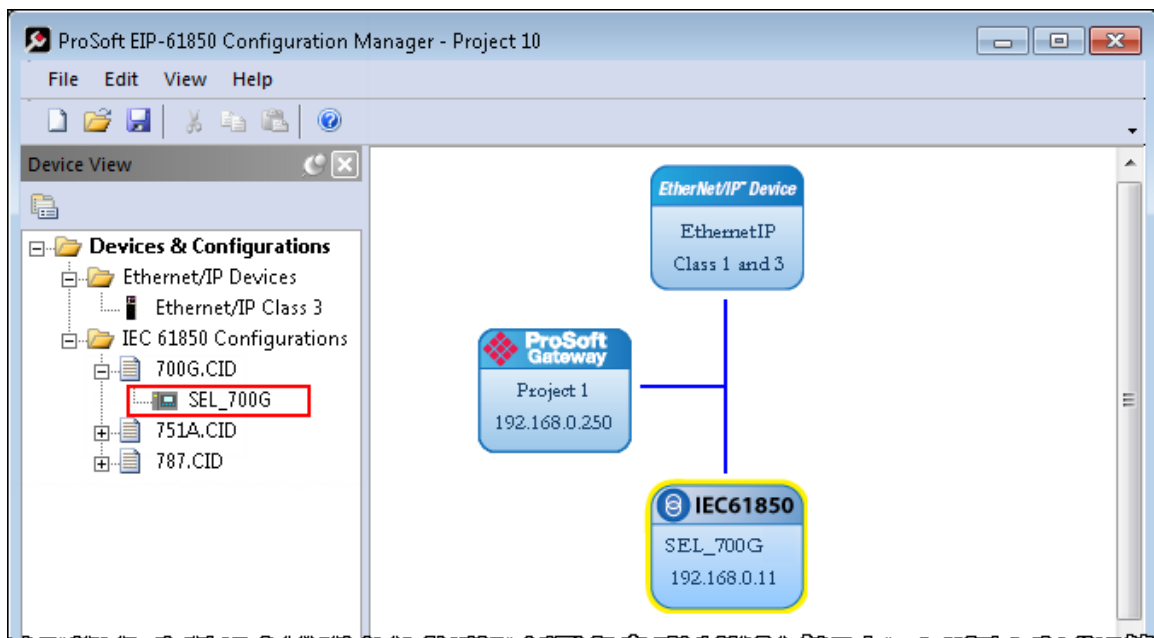

- 3 Repeat the steps above to add more IEDs to the *Network View* pane.

To delete an IED from the Network View:

Right-click the IED bubble in the *Network View* and choose **DELETE**.

To change the MMS Scan Delay:

You can change the MMS Scan Delay for any IED. This is the only property you can change for an IED, as everything else is set in the IED configuration file.

Right-click the IED bubble in the *Network View* and choose **PROPERTIES**. By default, the **MMS SCAN DELAY** is set to 1000 milliseconds.

IEC 61850 Reports and GOOSE messages are generated by the IED and are not affected by the MMS Scan Delay. The MMS Scan Delay parameter also has no impact on MMS writes. The lower you set the MMS Scan Delay value, the more network capacity is consumed by MMS Read network traffic. If you do not configure an IED to read any Data Attributes using MMS messages, then this parameter has no effect.

The **EDIT NETWORK SETTINGS** button is only for troubleshooting under the direction of ProSoft Technical Support.

To locate the IED file:

The Configuration Manager stores its own copy of the CID, SCD, or ICD file for this IED.

- 1 Right-click the IED bubble in the *Network View* and choose **PROPERTIES**.
- 2 Click the **DETAILED PROPERTIES** tab to see the path on your PC where the Configuration Manager stores the file.

2.8 Mapping Data Attributes from IEDs to the Gateway

As you add IEDs to the *Network View*, the ProSoft EIP-61850 Configuration Manager reads the device information and builds a list of tags (Data Attributes) from the device file. In this step, you map tags from the IED to the gateway database. This is the first of two steps in mapping data from the IED to the PAC:

- 1 First, you map the tag from the device to the gateway. This creates a location in the gateway database to store the data associated with the tags.
- 2 Second, you map the tag from the gateway database to the gateway EtherNet/IP port. This sets up an MMS data movement (IEC 61850-8-1) to push the data to the Logix processor (if the tag can be read) or to write to data to the device (if the tag can be written). Refer to Mapping Tags in the Gateway to EtherNet/IP (page 33) for this second step.

Note: Remember that you must configure the gateway so that the IP address is in the same subnet as the 61850 relay device. Refer to Configuring the Gateway EtherNet/IP Adapter (page 16).

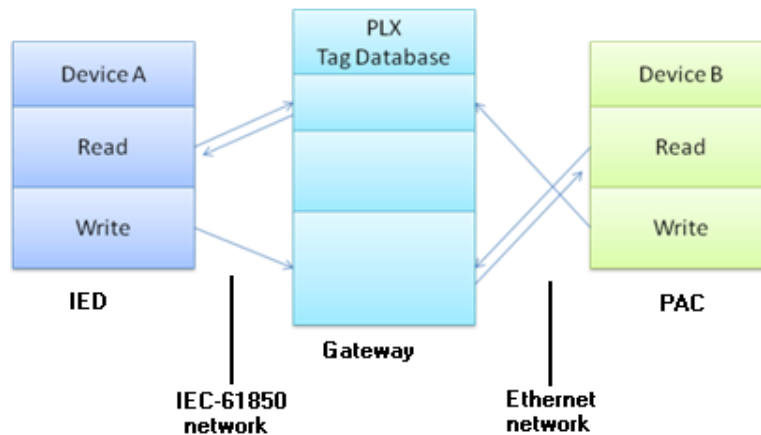

2.8.1 Mapping MMS Messages

MMS messages can be read-only (read the value from the IED) or write (write the value to the IED).

- 1 In the *Network View* pane in the ProSoft EIP-61850 Configuration Manager, right-click the *IED* bubble that you want to map, and choose **CONFIGURE**.

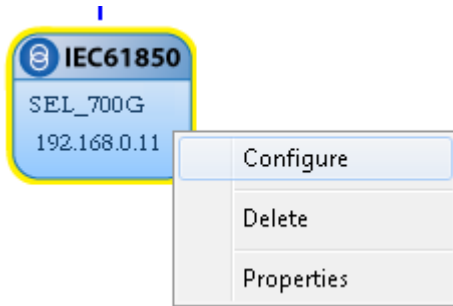

This displays the *IEC 61850 Mapping Tool* window. The window contains the tree view on the left, and the mapping table on the right.

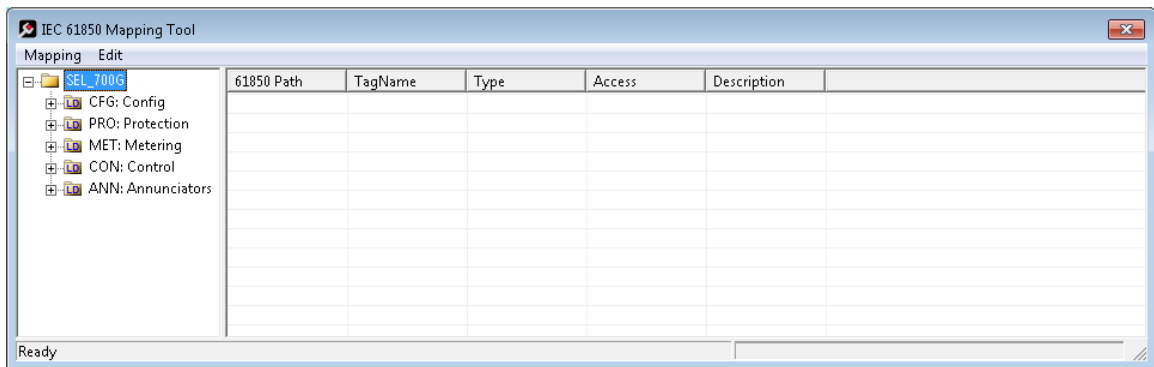

- 2 In the tree view on the left, expand the root folder (click the **[+]** sign). This shows the Logical Devices in the IED (notice the little LD in the icon).
- 3 Expand one of the Logical Devices in the IED (click the **[+]** sign) to see the Logical Nodes within it (notice the little LN in the icon). Some IED manufacturers provide descriptive information in their CID files. The ProSoft EIP-61850 Configuration Manager displays that information after the Logical Node name.

- 4 Continue to expand the Logical Node to display the Data Object (DO) and finally the individual Data Attributes. The functional constraint for a data attribute appears on the icon; for example CO for control, ST for status information, and CF for configuration (see Functional Constraints (page 106)).

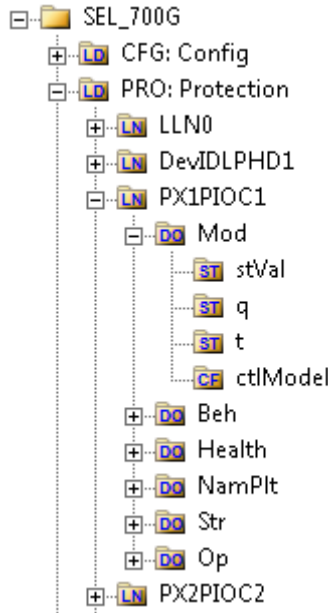

- 5 Click and drag a Data Attribute from the tree into the mapping table on the right. When you drop the Data Attribute, it fills in the table with the following values:
 - **61850 PATH** to the Data Attribute.
 - **TAGNAME** generated for the Data Attribute. This can be quite long, and is close to the actual Data Attribute name. Most devices have tag names that are short enough to map to RSLogix5000 projects. For tags that exceed this length, the Configuration Manager automatically shortens the name, ending with a sequence number (_001, _002, ...).
 - **TYPE** is the data type for the Data Attribute.
 - **ACCESS:** The Configuration Manager determines the read/write access of the tag the tag’s functional constraints:
R indicates data that the gateway can read from the IED.
W indicates data that the gateway can write to the IED.
 - **DESCRIPTION:** Enter a description for this Data Attribute.

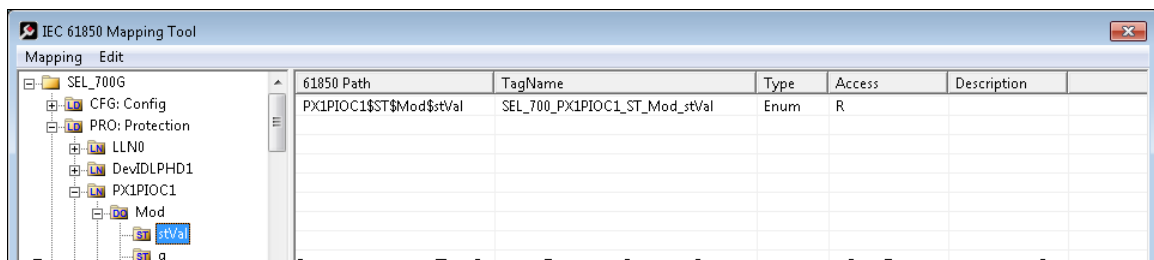

- 6 To delete tags, select the tag or tags in the table, then right-click the selected tags and choose **DELETE**.

- 7 Repeat until you have mapped the tags for the IED.
- 8 Choose **MAPPING > SAVE** to save the tag mapping. The mapped tags appear in the *Assigned Tags* pane at the lower-right of the Configuration Manager when you click the IED bubble.

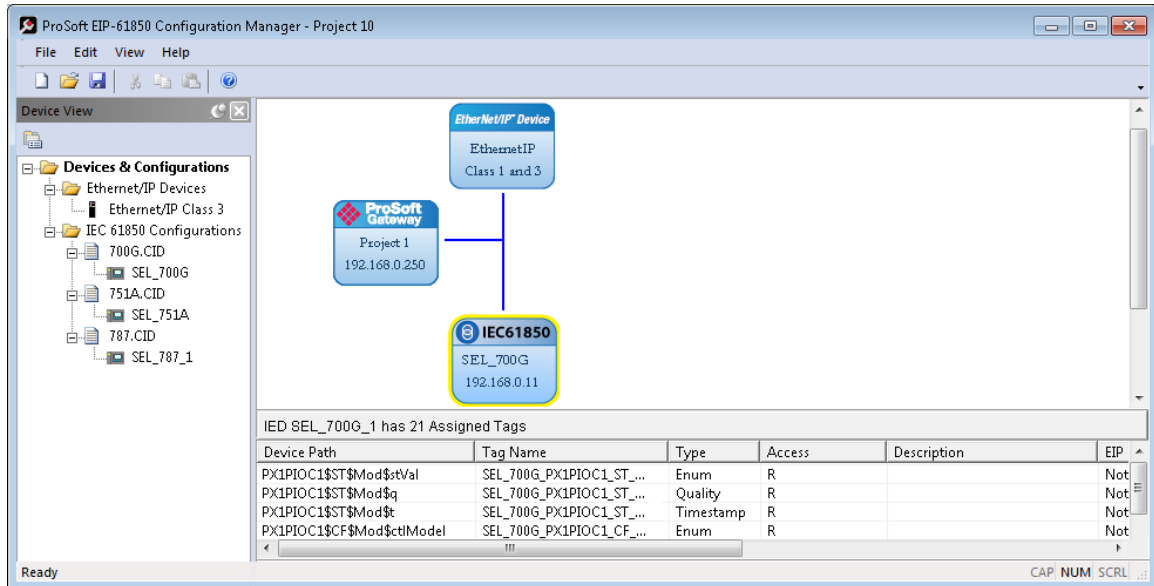

Note: You can click and drag a higher level object (such as a logical node (LN), a logical device (LD), or the IED) to map ALL the child tags descending from the higher level object. For MMS Write Data Attributes, see Mapping MMS Write Messages (page 25).

- 9 At this point, you have mapped the tags from the IED to the gateway internal database. If you download the configuration to the gateway at this point, the IEC 61850 client starts to read the values of the Data Attributes from the IED. The gateway processes the list of configured IEDs in order, one at a time, based on the MMS Scan Delay Timer. This parameter defines the interval between MMS Read commands. See Creating the IED Network (page 20) for more on this parameter.
- 10 The next step is to map the tags from the internal database to the EtherNet/IP output. Refer to Mapping Tags in the Gateway to EtherNet/IP (page 33).
- 11 If you want to delete one or more mappings, see Deleting one or more IEC 61850 mappings (page 32).

You can map other data from the IED.

- Mapping Reports (page 27)
- Mapping GOOSE Messages (page 30)

2.8.2 Mapping MMS Write Messages

You map MMS Write messages using the same steps described for all MMS messages. See Mapping MMS Messages (page 22). For writable data, drag and drop the Oper structure from the tree view on the left to the right-hand side of the window.

Important: In addition to the Oper structure, some IEDs also offer SBOw and Cancel structures within the same Data Object. For the gateway, you only need to map the Oper structure. Do not map the SBOw. The Cancel structure should only be mapped if it is required.

We strongly recommend that you map all of the Data Attributes surrounding the actual control value, and set up another exchange to read it before changing the control value and performing a write from the PLC or PAC side.

In the ProSoft EIP-61850 Configuration Manager, Oper structures that are supported by the IED have a green indicator, meaning that these may be mapped to the gateway. Those with a red indicator are not required to be mapped.

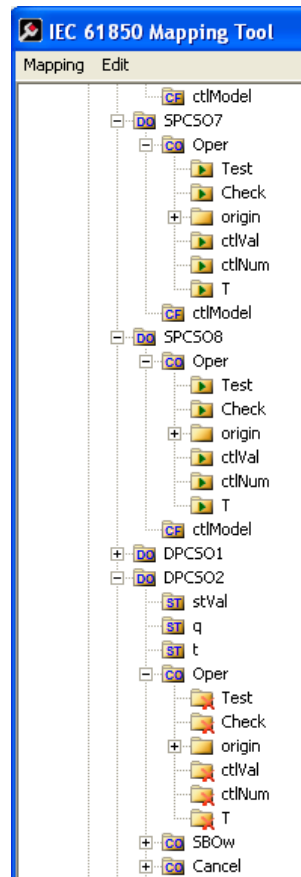

2.8.3 Mapping Reports

Reports are based upon a DATA-SET, containing a specific collection of Data Attributes. You can configure the gateway to enable an IED's Buffered Report Control Blocks (BRCBs) or Unbuffered Report Control Blocks (URCBs).

Note: Be sure that the DATA-SET on your IED contains all Data Attributes and not Data Objects.

- 1 In the *Network View* pane in the ProSoft EIP-61850 Configuration Manager, right-click the *IED* bubble that you want to map, and choose **CONFIGURE**.

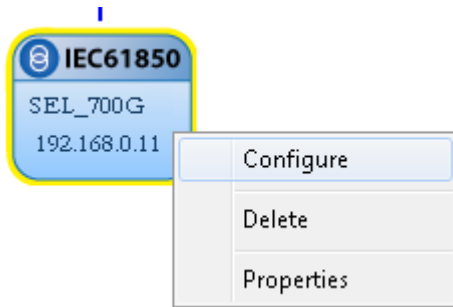

This displays the *IEC 61850 Mapping Tool* window.

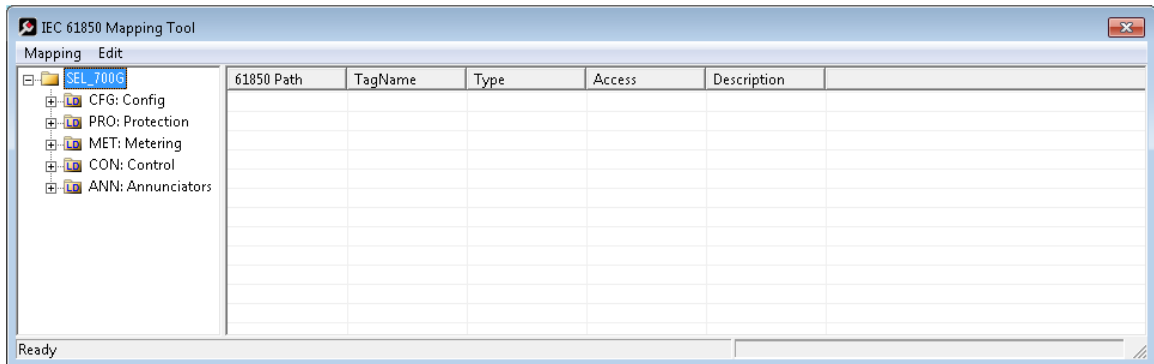

- 2 In the tree view on the left, expand the root folder (click the **[+]** sign).
- 3 Expand the Logical Device to see the Logical Nodes (click the **[+]** sign).

- Continue to expand the Logical Node to display the Reports Object (RPT) and finally the individual Reports.

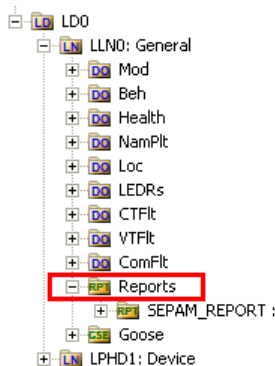

You can right-click a report name to see more information about the report, such as the Trigger Options and Report Control Block information.

- Click and drag the yellow folder showing the report name from the left side to the right side of the window. This maps the entire DATA-SET. You can also expand the individual report, then click and drag individual Data Attributes to the right side of the window. The functional constraint for a data attribute appears on the icon; for example ST for status information. See Functional Constraints (page 106).
- The Configuration Manager automatically populates the table with one row for each Data Attribute in that DATA-SET. When you drop the report or Data Attribute, it fills in the table with the following values:
 - 61850 PATH** to the Data Attribute.
 - TAGNAME** generated for the Data Attribute. This can be quite long, and is close to the actual Data Attribute name. Most devices have tag names that are short enough to map to RSLogix5000 projects. For tags that exceed this length, the Configuration Manager automatically shortens the name, ending with a sequence number (_001, _002, ...).
 - TYPE** is the data type for the Data Attribute.
 - ACCESS:** the ProSoft EIP-61850 Configuration Manager determines the read/write access of the tag's functional constraints:
R indicates data that the gateway can read from the IED.
W indicates data that the gateway can write to the IED.

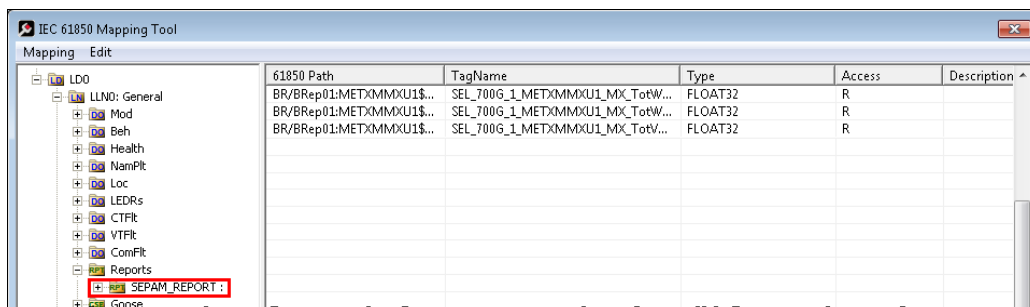

After you save the mapped tags, if you re-open the *IEC 61850 Mapping Tool* window, MMS read and write tags are highlighted in red. Report and Goose Message tags are not highlighted.

- 7 To delete tags, select the tag or tags in the table, then right-click the selected tags and choose **DELETE**.
- 8 Repeat until you have mapped the reports and individual Data Attributes for the IED.
- 9 Choose **MAPPING > SAVE** to save the tag mapping. The mapped report tags appear in the *Assigned Tags* pane at the lower-right of the Configuration Manager when you click the IED bubble.

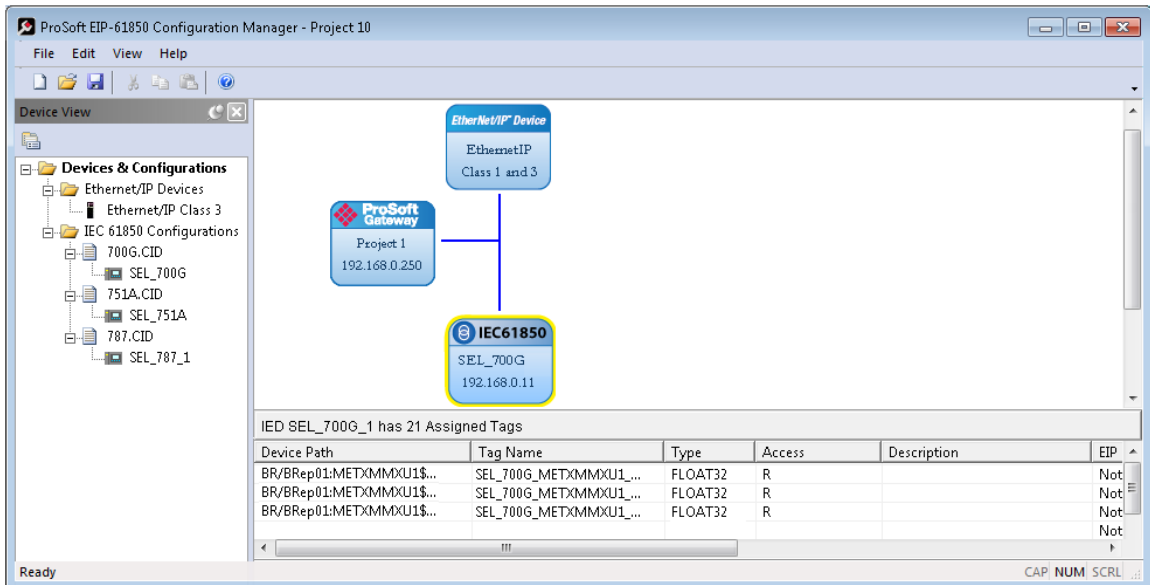

Note: The gateway stores the entire DATA-SET of data in the tag database. This make a consistently-sized set of data is available to the other protocol. You configure which Data Attributes are available when you map tags to the EtherNet/IP side of the gateway. See Mapping Tags in the Gateway to EtherNet/IP (page 33).

Report options are used as they are defined in the IED. The gateway supports General Interrogation (GI). Upon report enable, if the Report's trigger options have it set to TRUE, the gateway initiates a General Interrogation. This occurs during the first connection that the gateway makes to the IED, and on any subsequent reconnections. This ensures the gateway has a current snapshot of the values of all members of the report's DATA-SET.

2.8.4 Mapping GOOSE Messages

GOOSE (Generic Object Oriented Substation Events) messages are based upon a DATA-SET, containing a specific collection of Data Attributes. You can configure the gateway to enable an IED's GOOSE messages. GOOSE messages are based upon a DATA-SET. An entire GOOSE message must fit in one Ethernet packet. According to the IEC 61850 Standard, GSEControl information is only allowed in the logical node LLN0.

- 1 In the *Network View* pane in the ProSoft EIP-61850 Configuration Manager, right-click the *IED* bubble that you want to map, and choose **CONFIGURE**.

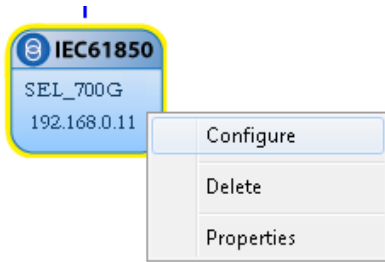

This displays the *IEC 61850 Mapping Tool* window.

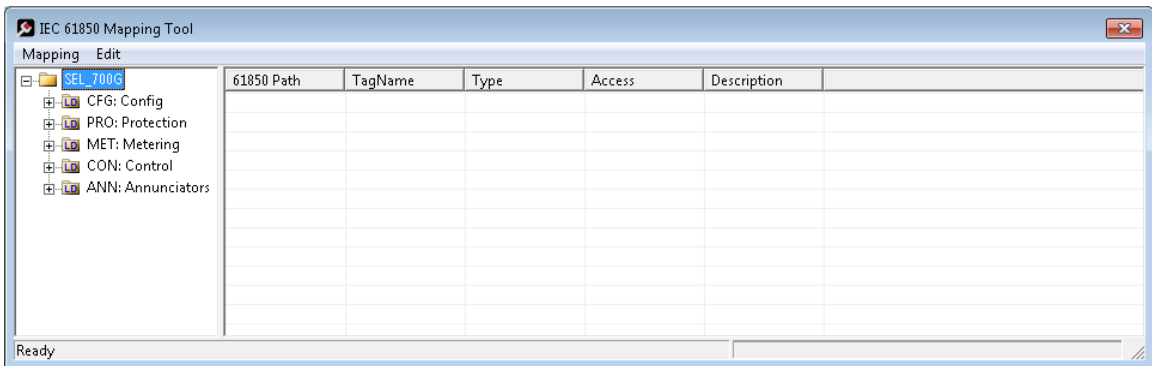

- 2 In the tree view on the left, expand the root folder (click the **[+]** sign).
- 3 Expand the Logical Device to see the Logical Nodes (click the **[+]** sign).
- 4 Continue to expand the Logical Node to display the GOOSE (GSE) and finally the individual DATA-SETS.

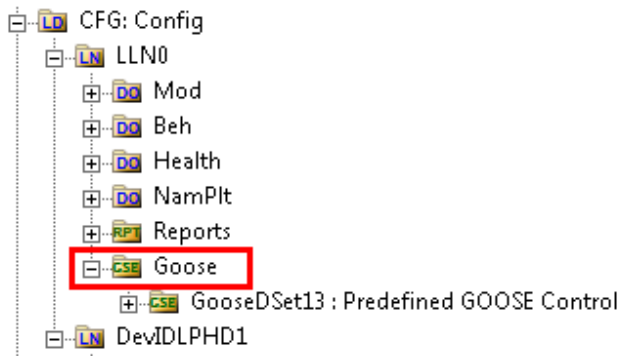

- 5 Click and drag the yellow folder showing the DATA-SET name from the left side to the right side of the window. This maps the entire DATA-SET. You can also expand the individual DATA-SET, then click and drag individual Data Attributes to the right side of the window. The functional constraint for a data attribute appears on the icon; for example ST for status information. See Functional Constraints (page 106).
- 6 The Configuration Manager automatically populates the table with one row for each Data Attribute in that DATA-SET. When you drop the report or Data Attribute, it fills in the table with the following values:
 - **61850 PATH** to the Data Attribute. The ProSoft EIP-61850 Configuration Manager adds GOOSE as a prefix to the standard IEC-61850 path.
 - **TAGNAME** generated for the Data Attribute. This can be quite long, and is close to the actual Data Attribute name. Most devices have tag names that are short enough to map to the PLC or PAC. For tags that exceed this length, the Configuration Manager automatically shortens the name, ending with a sequence number (_001, _002, ...).
 - **TYPE** is the data type for the Data Attribute.
 - **ACCESS:** the ProSoft EIP-61850 Configuration Manager determines the read/write access of the tag's functional constraints:
R indicates data that the gateway can read from the IED.
W indicates data that the gateway can write to the IED.

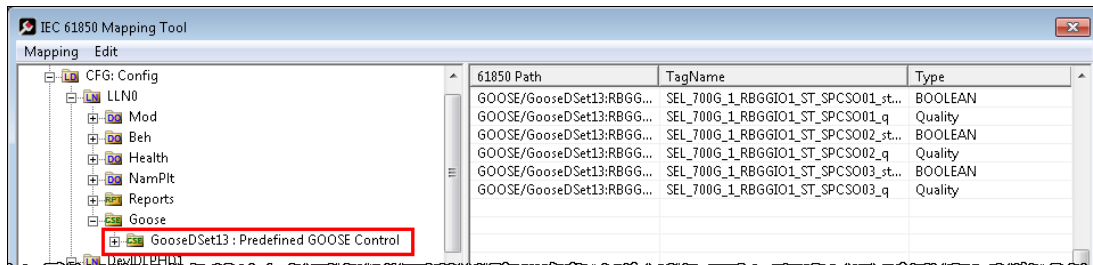

After you save the mapped tags, if you re-open the *IEC 61850 Mapping Tool* window, MMS read and write tags are highlighted in red. Report and Goose Message tags are not highlighted.

- 7 To delete tags, select the tag or tags in the table, then right-click the selected tags and choose **DELETE**.
- 8 Repeat until you have mapped the GOOSE DATA-SETS and individual Data Attributes for the IED.

- Choose **MAPPING > SAVE** to save the tag mapping. The mapped tags appear in the *Assigned Tags* pane at the lower-right of the Configuration Manager when you click the IED bubble.

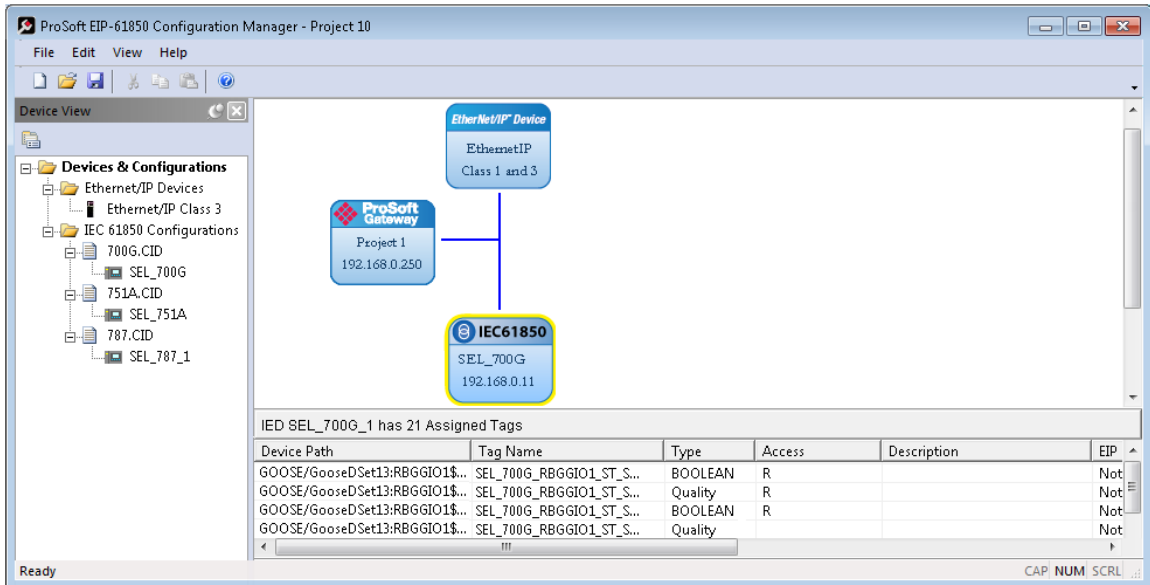

2.8.5 Deleting one or more IEC 61850 mappings

You can delete one or more MMS messages, Report, and GOOSE mapping from the IED to the gateway.

- In the *Network View* pane in the ProSoft EIP-61850 Configuration Manager, right-click the *IED* bubble that you want to map, and choose **CONFIGURE**. This displays the *IEC 61850 Mapping Tool* window. The mappings are listed in the table on the right side of the window.
- Select the mappings in the table, then right-click the selected mappings and choose **DELETE**. You can also delete all the mappings by choosing **EDIT > CLEAR ALL**.
- Note that if you delete a mapping from the IED to the Gateway, you also delete the corresponding mapping on the EtherNet/IP side of the Gateway. See Mapping Tags in the Gateway to EtherNet/IP (page 33).

2.9 Mapping Tags in the Gateway to EtherNet/IP

After you have mapped the MMS messages, Report, and GOOSE mapping from the IED to the gateway, you must map these tags to the EtherNet/IP side of the gateway. This makes the tags and associated data available to the PLC. This is the second of two steps in mapping data from the IED to the PAC.

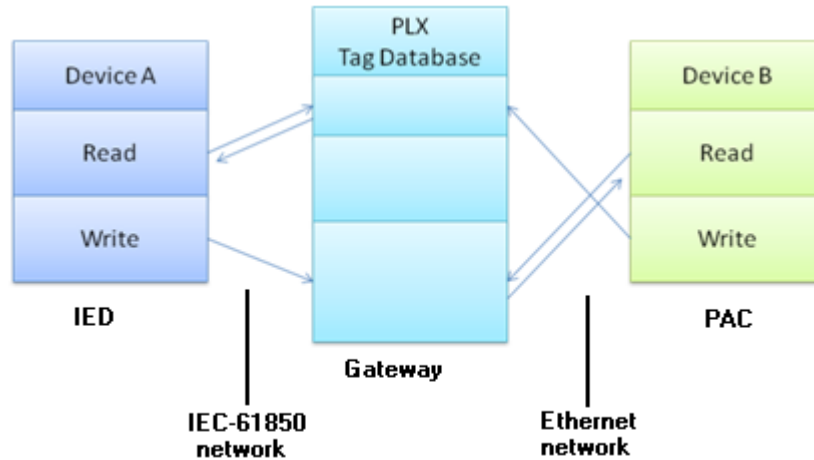

- 1 First, you mapped the tag from the device to the gateway. This creates a location in the gateway database to store the data associated with the tags. Refer to Mapping Data Attributes from IEDs to the Gateway (page 22) for this first step.
- 2 Second, you map the tag from the gateway database to the gateway EtherNet/IP port. This sets up an MMS data movement (IEC 61850-8-1) to push the data to the Logix processor (if the tag can be read) or to write to data to the IED (if the tag can be written).

In the Network View pane in the ProSoft EIP-61850 Configuration Manager, double-click the *EtherNet/IP Device* bubble.

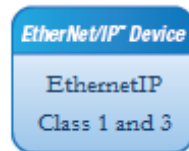

This displays the *EtherNet/IP Mapping Tool* window.

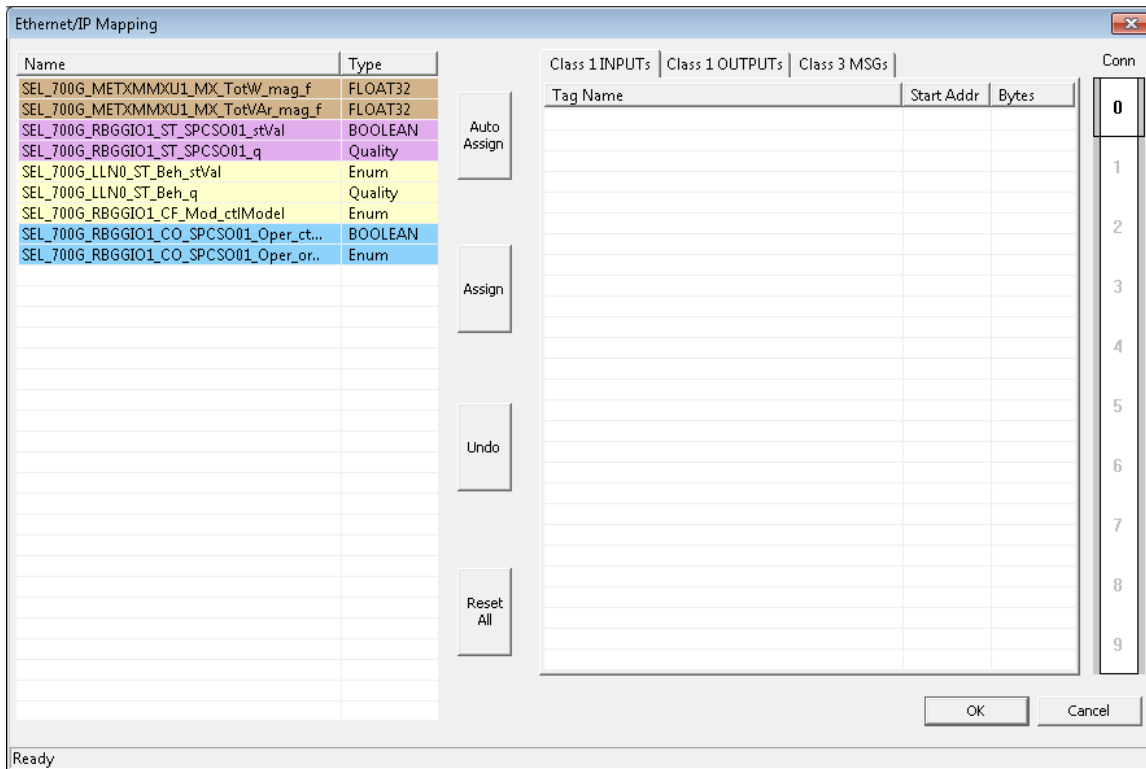

The tags (Data Attributes) you mapped from the IED to the gateway appear on the left-hand side of the window. The tags you map from the gateway to the processor appear on the right-hand side of the window, and are highlighted in one of three colors:

- Tags that can be read from the IED are highlighted in yellow.
- Tags that can be written to the IED are highlighted in blue.
- Tags that are string data are highlighted in Brown. This includes tags from Reports.
- Tags that come from GOOSE messages are highlighted in purple.

You must map tags to an output on the right-hand side. You must map the available tags on the left-hand side to one of the three tabs on the right-hand side of the window.

- **CLASS 1 INPUTS** is for tags that can be read from the IED (yellow, brown, purple). These are output on the gateway EtherNet/IP as Class 1 messages. For more on Class 1 inputs, see EtherNet/IP (EIP) Specifications (page 83).
- **CLASS 2 OUTPUTS** is for tags that can be written to the IED (blue). Write tags are highlighted in blue. These can be written by the PLC to EtherNet/IP on the gateway as Class 1 messages.
- **CLASS 3 MSGS** is for any tag. In particular, if your application requires more Data Attributes than the supported number of bytes that can be transferred by EtherNet/IP Class 1 messaging, you must use Class 3 messages. These must be explicitly read or written by the PLC using Class 3 messaging. For more on Class 3 messages, see EtherNet/IP (EIP) Specifications (page 83).

The **CONN** slider allows you to choose the connection for the tags you are about to map as Class 1 Inputs or Class 2 OUTPUTs. For the PLX82-EIP61850, you can map tags to as many as 20 connections to 20 different PLCs, and each tag can be mapped to only one connection. Class 3 messages are explicit messages where you edit and create MSG instructions in the PLC to read/write to specific areas of the gateway memory. No connection parameters need to be defined.

You can map tags in several ways:

- You can click and drag one or more tags from the left-hand side to the current tab right-hand side.
- You can select one or more tags and click **ASSIGN**.
- You can map all the tags by clicking **AUTO ASSIGN**. This automatically maps all the available tags to the correct tab. All read tags are mapped to Class 1, and all write tags are mapped to Class 2.

If you try to map a tag to the wrong tab using click and drag, or the **ASSIGN** button, the Configuration Manager displays an error message and maps the tag to the correct tab.

To delete one or more mappings

Select the mappings you want to delete in the right-hand table, then click **UNDO**. You can delete all mappings by clicking **RESET ALL**. Deleting a mapping on the EtherNet/IP side of the gateway does not delete the mapping from the IED to the Gateway.

Note that if you delete a mapping from the IED to the Gateway, you also delete the corresponding mapping on the EtherNet/IP side of the Gateway. See *Deleting one or more IEC 61850 mappings* (page 32).

2.10 Validating the Configuration

You can validate the configuration file before downloading it to the gateway.

- 1 Right-click the *Project* bubble and choose **DOWNLOAD FROM PC TO DEVICE**.

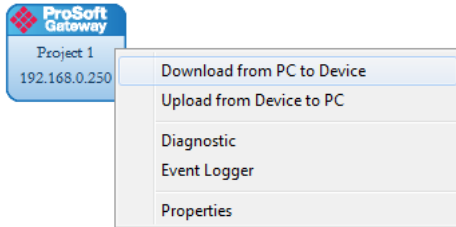

This displays the *Transfer File* dialog box.

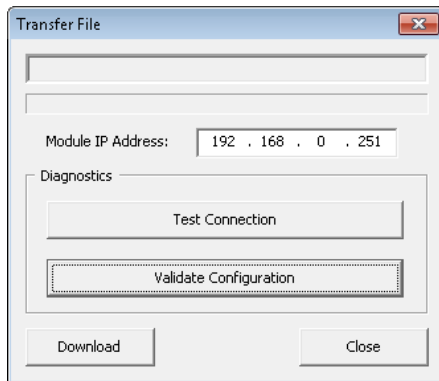

- 2 Click the **VALIDATE CONFIGURATION** button.

2.11 Downloading the Configuration File to the Gateway

After you have created the IEC 61850 project in the Configuration Manager software, you are ready to download it to the gateway.

Note: If you want to validate the configuration before downloading, refer to Validating the Configuration (page 35).

- 1 Right-click the *Project* bubble and choose **DOWNLOAD FROM PC TO DEVICE**.

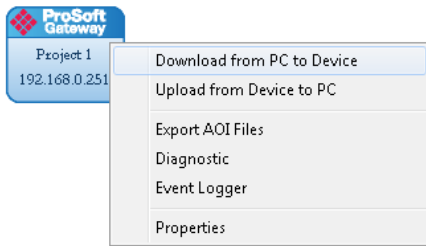

This displays the *Transfer File* dialog box.

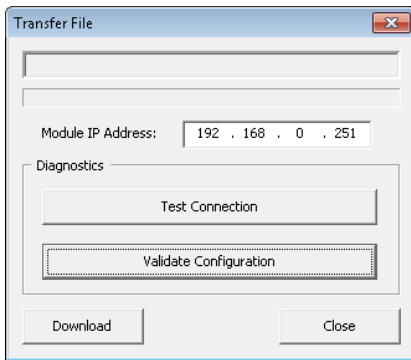

- 2 Click **TEST CONNECTION**. If the gateway's IP address does not match what was entered in ProSoft EIP-61850 Configuration Manager, then the software displays an error message:
"Error: Connecting to Module. Please check your IP Address."
If the gateway's IP address matches the address in the Configuration Manager, and the software displays the following message: *"Successfully connected."*
- 3 Click **DOWNLOAD** to download the project to the gateway.

Note: If you see the *Error: Download Configuration* message, make sure that the MODE 3 jumper is correctly installed on both pins for configuration. Refer to Setting Jumpers (page 9).

If you need to change MODE 3 jumper, note that the jumper setting is only read by the module when it powers up; therefore you must reboot the gateway before it can recognize the change in the jumper setting.

2.12 Uploading the Configuration from the Gateway

You can use this feature to retrieve the configuration from the gateway. Not only does it retrieve the configuration, but it also retrieves all the CID, ICD, and/or SCD files used in creating that configuration. There are several reasons that you might use this feature:

- You want to modify the configuration, but do not have access to the original configuration files.
- You want to copy a configuration from one gateway to another gateway.
- You want to back up the configuration for safety.

Warning: This function replaces the current configuration in the ProSoft EIP-61850 Configuration Manager with the one from the gateway. Make sure you save the current configuration before uploading the configuration from the gateway.

- 1 Optional: Create a new project in the ProSoft EIP-61850 Configuration Manager by choosing **FILE > NEW**.
- 2 Right-click the *ProSoft Gateway* bubble and choose **UPLOAD FROM DEVICE TO PC**.

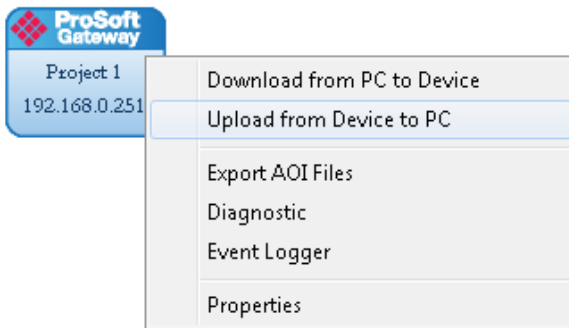

The Configuration Manager uploads the configuration from the gateway and displays it. You can then edit the configuration or save it on the computer.

2.13 Exporting the IED Add-On Instructions for RSLogix 5000

After downloading a configuration file to the module, you must export the Add-On Instruction (.L5X) file to be used in RSLogix 5000. This creates the Add-On Instructions for the IEDs that you imported Refer to Importing IED Files (page 18). The ProSoft EIP-61850 Configuration Manager creates one AOI file for each IED in the network configuration (IEDs that appear as bubbles in the Network View pane).

Important: The AOI file name and the Controller Tags within the AOI must start with a letter of the alphabet. It cannot start with a numeral as the AOI cannot be properly imported by the RSLogix 5000 application.

To prevent AOI Controller Tags from starting with a numeral, check that the IED Name within the CID, SCD, or ICD files starts with a letter.

- 1 To export the IED files, right-click the *ProSoft Gateway* bubble in the Network View and choose **EXPORT AOI FILES**.

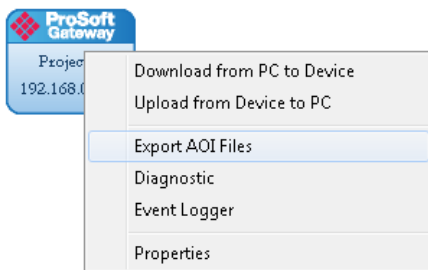

- 2 In the *Save As* dialog box, navigate to the correct directory and save the AOI files.

Note: Each IED in the network configuration must have a unique device name because the Configuration Manager uses the name to build the Add-On Instruction. The .L5X AOI file contains all the tags and ladder logic defined in your IEC 61850 project. Since the Configuration Manager builds a User-Defined Data Type (UDT) for RSLogix 5000, each device must have fewer than 512 configured IEC 61850 tags (with a BOOL data type occupying 2 tags, and all other data types occupying one tag).

2.14 Exporting a Project from the Configuration Manager

You can export a ProSoft EIP-61850 Configuration Manager file that you created on your PC. Exporting a project includes all the original IED files that you used to create the project into the export file. This allows someone on a different PC to import your configuration file and have all the CID/SCD/ICD files that are part of your project. If you need assistance from ProSoft Technology Technical Support, they will need your configuration file.

- 1 In the ProSoft EIP-61850 Configuration Manager choose **FILE > EXPORT CONFIGURATION**.
- 2 In the *Save As* dialog box, navigate to the correct directory and save the configuration file.

Note: You can also upload the configuration from the gateway, and then save it to a file. Refer to *Uploading the Configuration from the Gateway* (page 37).

2.15 Importing Updated IED Files

You may need to make changes to the CID, ICD, or SCD files after you create the IED system configuration in the gateway. For example, you may need to modify a DATA-SET, or add or remove some Data Attributes. When you make changes like this, it's easy to update the project in the ProSoft EIP-61850 Configuration Manager with the new information.

- 1 Right-mouse-click on the **CID, SCD, OR ICD** filename you want to update in the *Device View* section of the ProSoft EIP-61850 Configuration Manager and choose **UPDATE IED**.

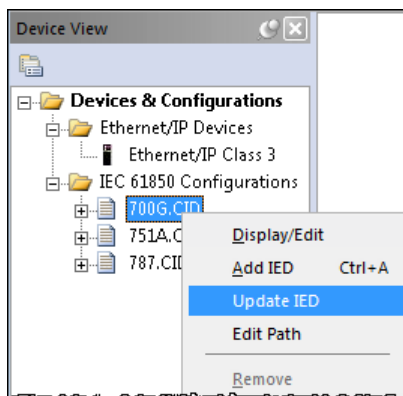

- In the *Open* dialog box, browse to the directory containing the ICD, CID, or SCD file. Often you use the exact same filename as when you first imported the file into the ProSoft EIP-61850 Configuration Manager.

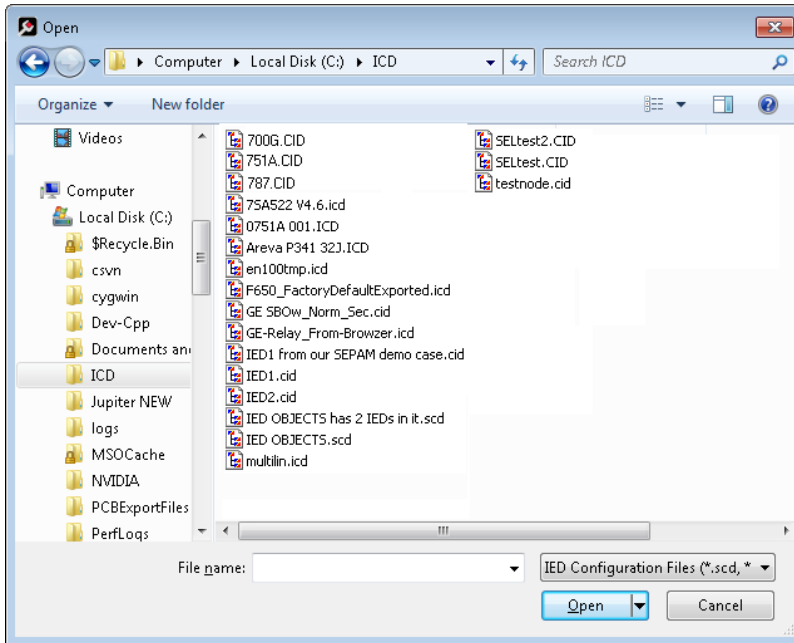

When you right-click the *IEC 61850* bubble representing that IED and choose **CONFIGURE**, the *IEC 61850 Mapping Tool* window shows the previously configured tags. If any of the previously configured Data Attributes for that IED are now missing from the new CID, SCD, or ICD file that you just imported, then those tags are highlighted in red. This lets you know that they are not in the updated IED file.

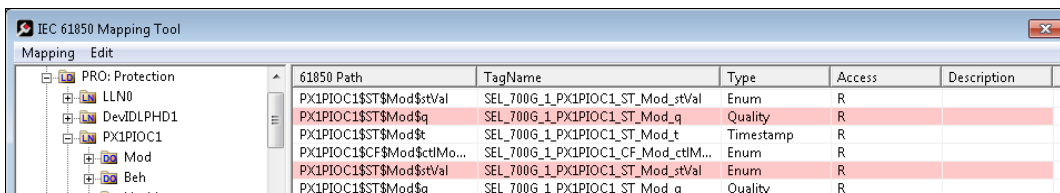

- Right-click the missing tag and choose **DELETE**. This removed the tag mapping for the IED. Any corresponding mappings on the EtherNet/IP side of the Gateway are also deleted.
- When you have finished updating the mapping, choose **MAPPING > SAVE** to save the changes.
- Download the updated project to the gateway.

3 Configuring the EtherNet/IP Driver

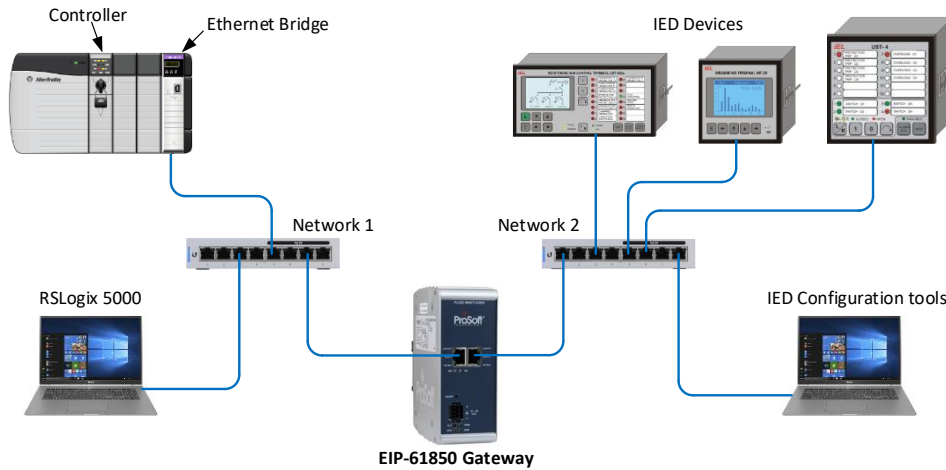

3.1 Create or open a project in RSLogix 5000

Before you can import the IED tags from the ProSoft EIP-61850 Configuration Manager into RSLogix 5000, you must create a new project or open an existing project.

If you want to add the PLX82-EIP-61850 gateway to an existing project, skip to Adding an Ethernet Bridge (page 43).

To create a new project:

- 1 In RSLogix 5000, choose **FILE > NEW**.
- 2 Select your EtherNet/IP scanner (ControlLogix, or CompactLogix PAC).
- 3 Select **REVISION 16** or newer.
- 4 Enter a name for your controller, such as **MY_CONTROLLER**.
- 5 Select your PAC chassis type and click **OK**.

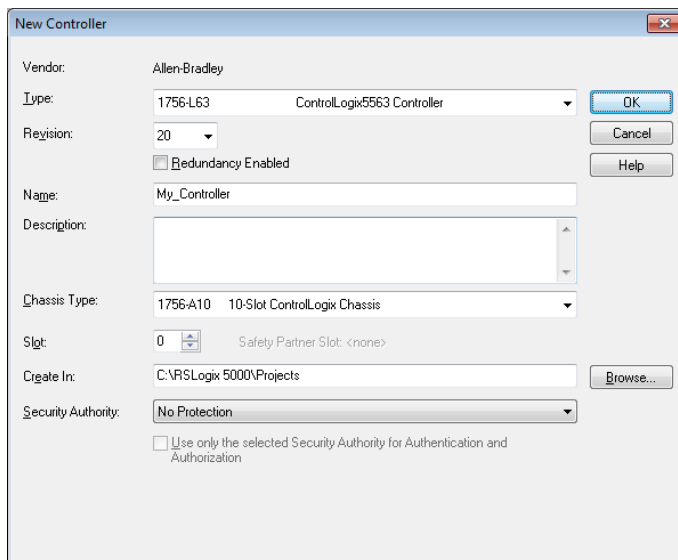

3.2 Adding an Ethernet Bridge

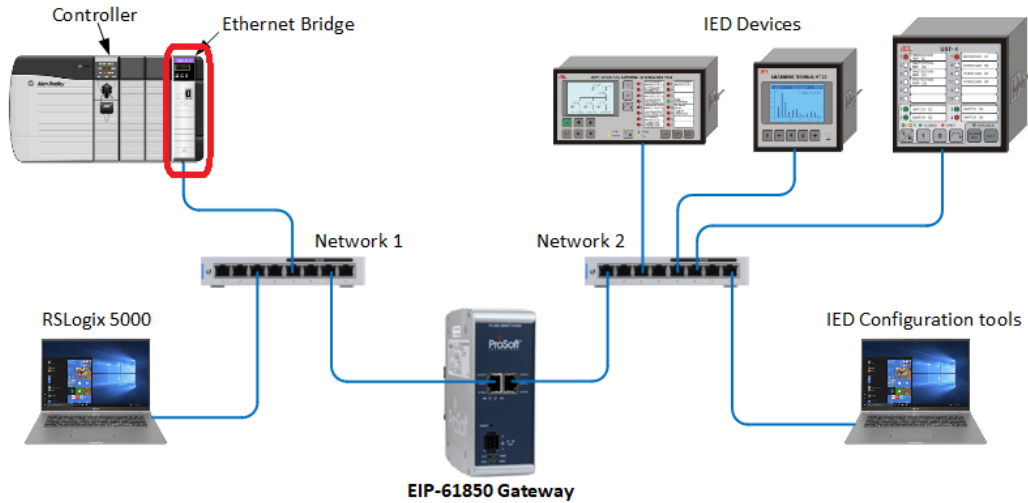

- 1 Expand the **I/O CONFIGURATION** folder in the Project tree. Right-click the appropriate communications bus and choose **NEW MODULE**.

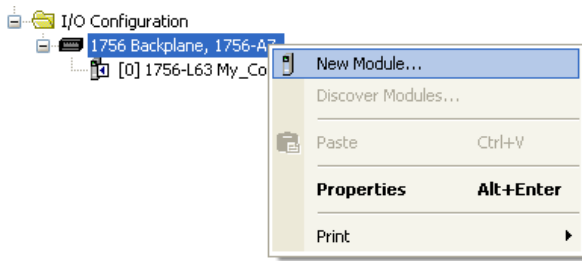

- 2 This opens the *Select Module Type* dialog box.
- 3 For this example, click the **1756-ENBT ETHERNET BRIDGE** and then click **CREATE**.

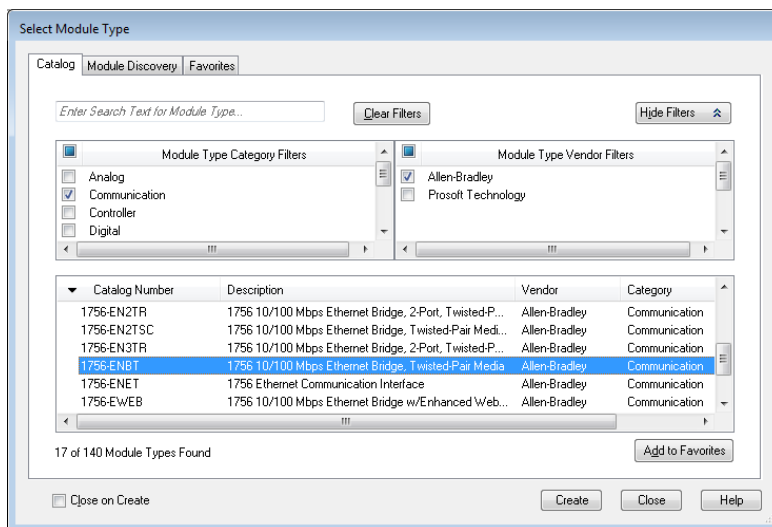

- 4 Enter the name, revision, and IP address for the 1756-ENBT and then click **OK**.

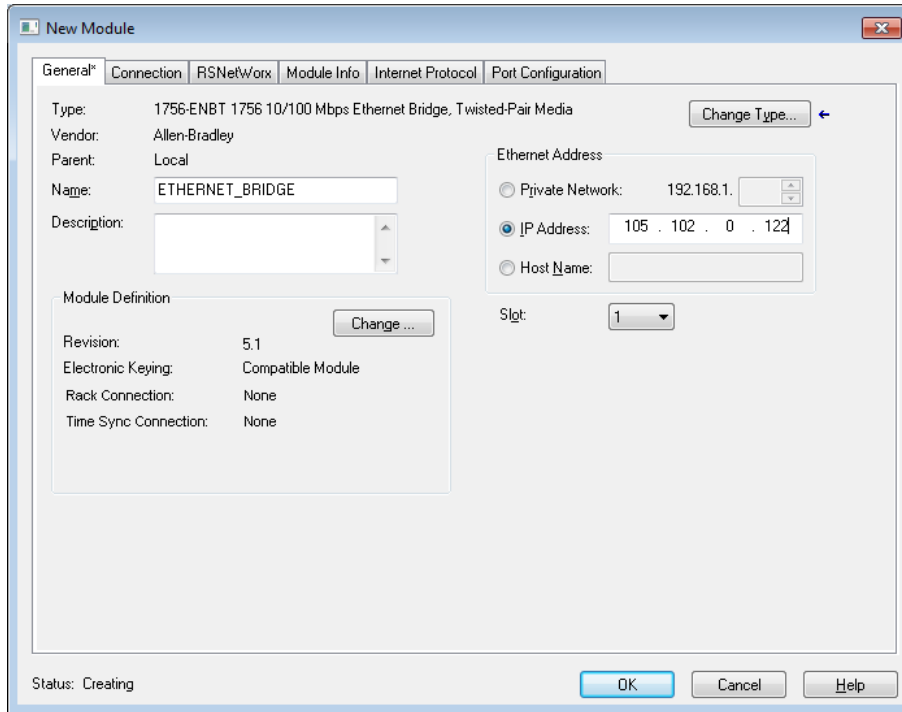

3.3 Adding the Gateway

- 1 In RSLogix 5000, under the 1756-ENBT, right-click **ETHERNET** and then choose **NEW MODULE**.

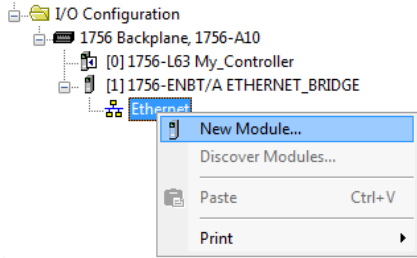

- 2 Select the **GENERIC ETHERNET/IP CIP BRIDGE** and then click **CREATE**.

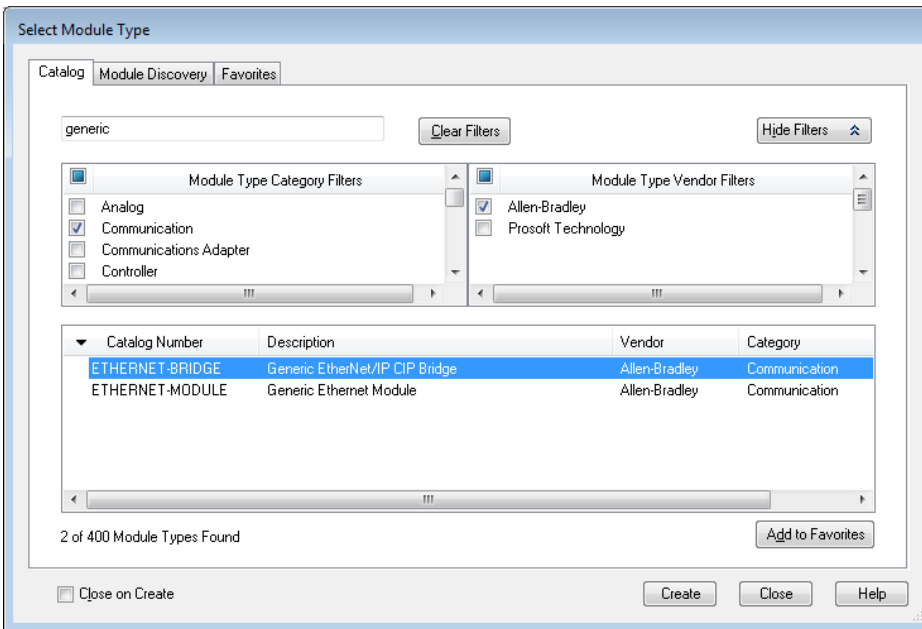

- 3 Enter the name and IP address for the gateway and then click **OK**.

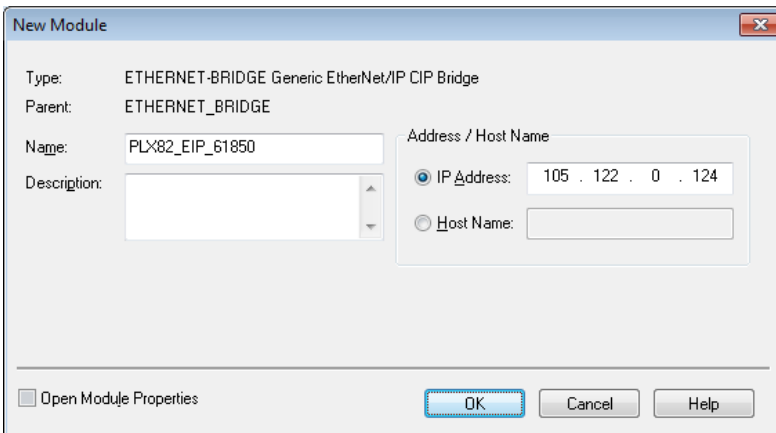

- 4 Under the gateway (PLX81_EIP_61850 in this example), right-click **CIP Bus** and then choose **NEW MODULE**.

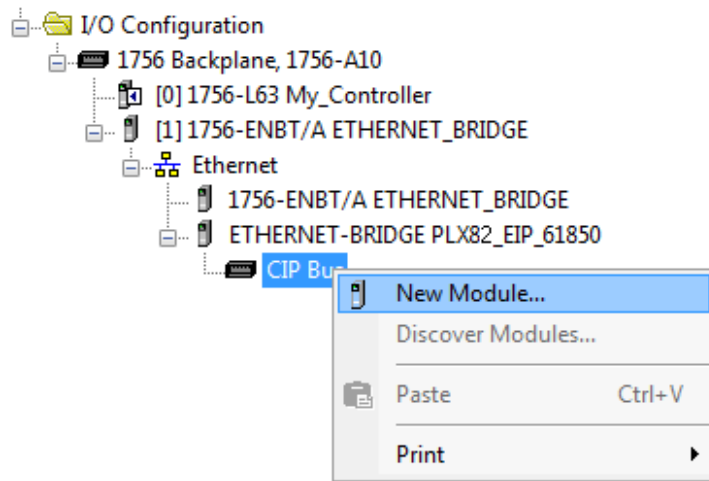

- 5 Click the **GENERIC CIP MODULE** and then click **CREATE**.

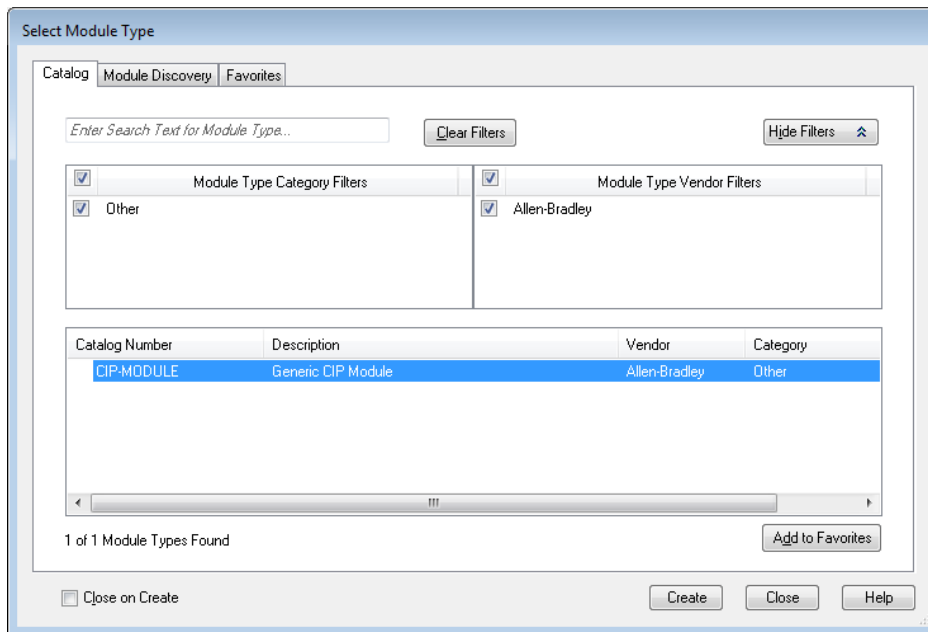

- 6 Add a Class 1 connection (enter the name and configuration parameters). Enter the Name, select **SINT** for **COMM FORMAT**, and enter the **CONNECTION PARAMETERS** as shown below. Then click **OK**.

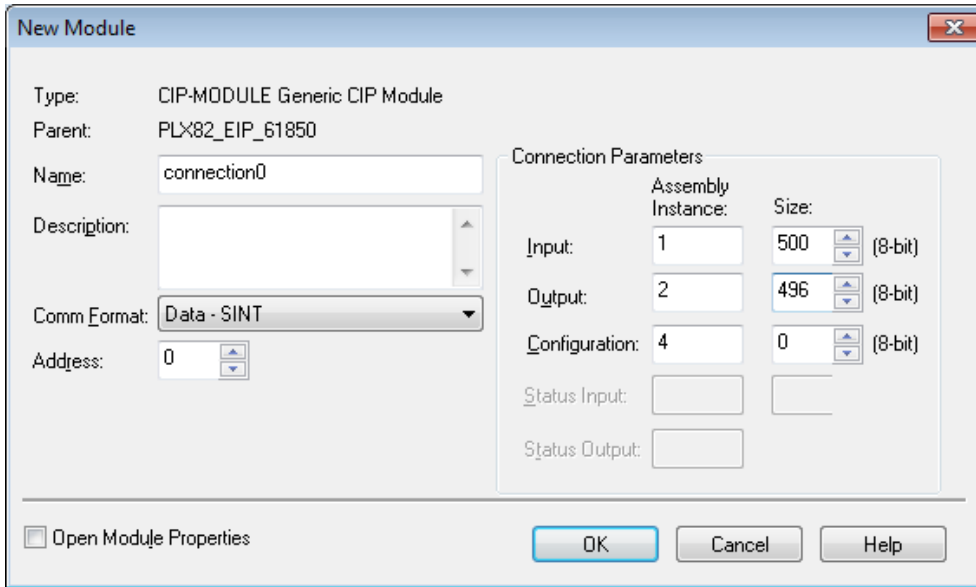

- 7 Right-click the new connection and then choose **PROPERTIES**.

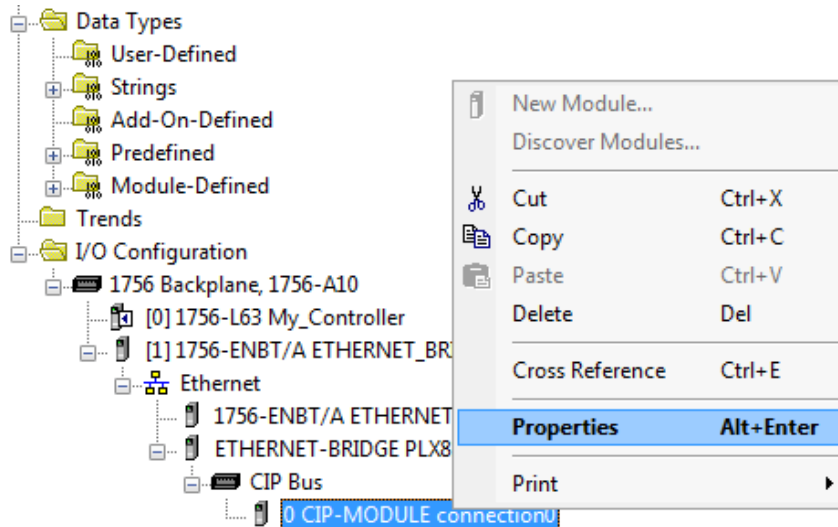

- 8 On the **CONNECTION** tab, enter the **REQUESTED PACKET INTERVAL** time and then click **OK**.

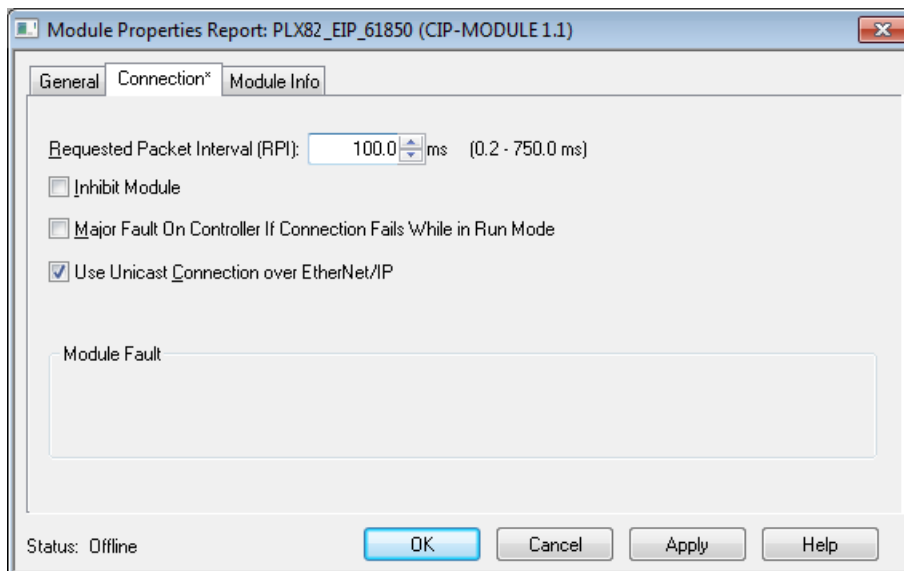

3.4 Download the project to the processor to verify the connection

- 1 Save, and then download the project to the processor.
- 2 A yellow triangle in RSLogix 5000 means an error on connection. Check that the **OUTPUT** size and **INPUT** size for the Class 1 connection in the gateway configuration matches and the **COMM FORMAT** is **SINT**. Try increasing the **REQUESTED PACKET INTERVAL** time of module if the error persists.
- 3 If errors persist, download the configuration again to make sure that the module configuration matches the configured RSLogix 5000 program.
- 4 For additional troubleshooting, use the ProSoft EIP-61850 Configuration Manager. Right-click the **PROSOFT GATEWAY** bubble, and click **DIAGNOSTIC**.

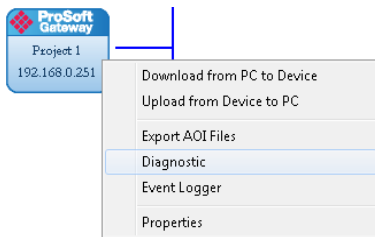

Class 1 displays the connection RPI time of processor and the IP address of the ENBT. The open connection count starts at 1 and increments if the connection to the processor is interrupted or there is a connection timeout. State, open connection, and connection timeout are controlled by the code.

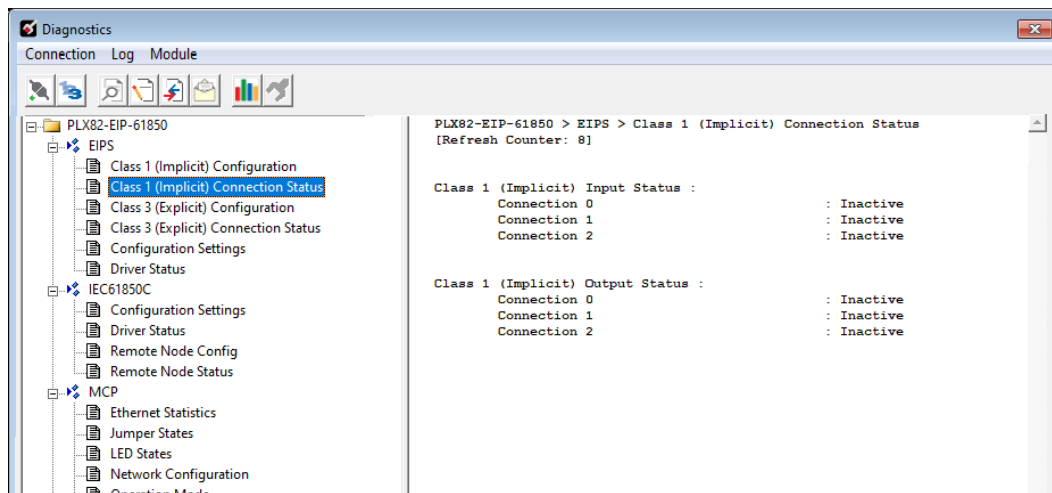

You can change the RPI and EtherNet/IP parameters in the ladder configuration in RSLogix 5000 (right-click **CONNECTION0** and click **PROPERTIES**).

3.5 Import the AOI from the Configuration Manager

- 1 In RSLogix 5000, choose **FILE > IMPORT COMPONENT > ADD-ON INSTRUCTION**.
- 2 Locate the directory with the Add-On Instructions you exported from the ProSoft EIP-61850 Configuration Manager. Refer to Exporting the IED Add-On Instructions for RSLogix 5000 (page 39).
- 3 Select the AOI files to import and click **IMPORT**.

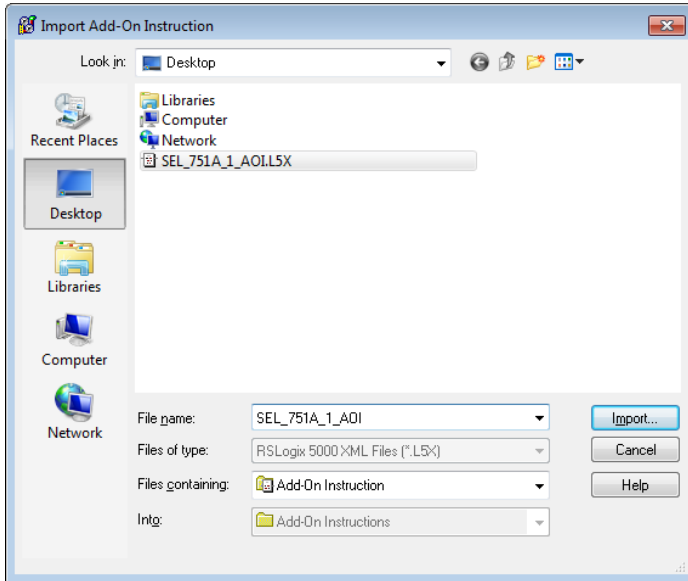

- 4 In the *Import Configuration* dialog box, make sure the **OPERATION** is set to **CREATE**, and then click **OK**.

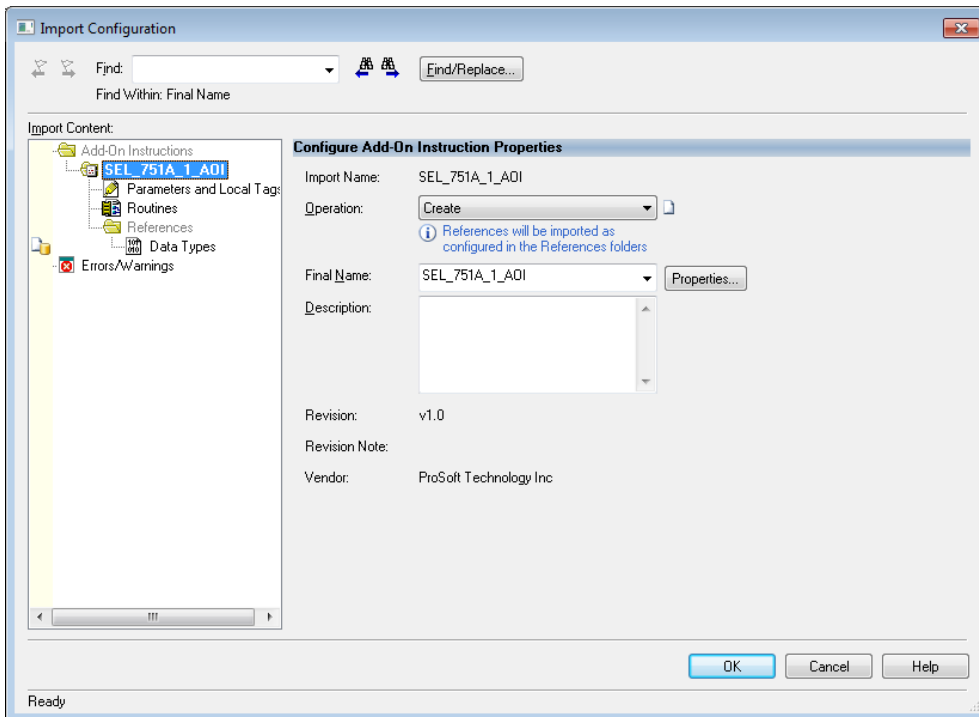

- 5 After the import completes, the Add-On Instruction appears under *Add-On Instructions* in the window.

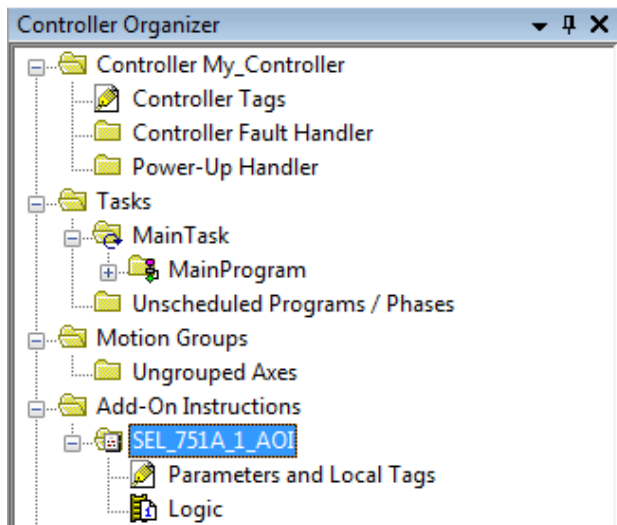

Note: If the Add-On Instruction does not import into RSLogix 5000 correctly, check to make sure you have less than 460 tags configured (each BOOL counts as 2 tags). You can do this by editing the AOI file using any text editor (such as Windows Notepad or Notepad++).

3.6 Adding the Rung to Your Project

- 1 In the *Controller Organizer*, double-click **MAIN ROUTINE** to open the Main Routine Ladder Editor.

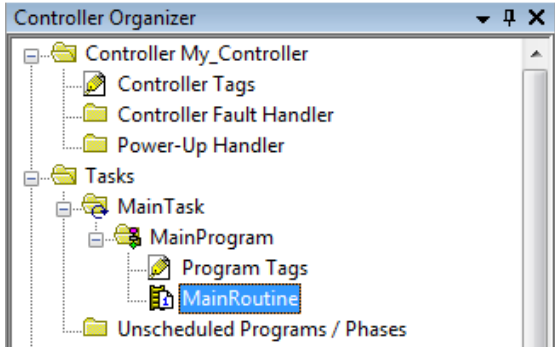

- 2 Click an empty ladder rung, and then in the *Instruction Selection* window, click **ADD-ON**.



- 3 Click and drag the Add-On instruction to an empty ladder rung.

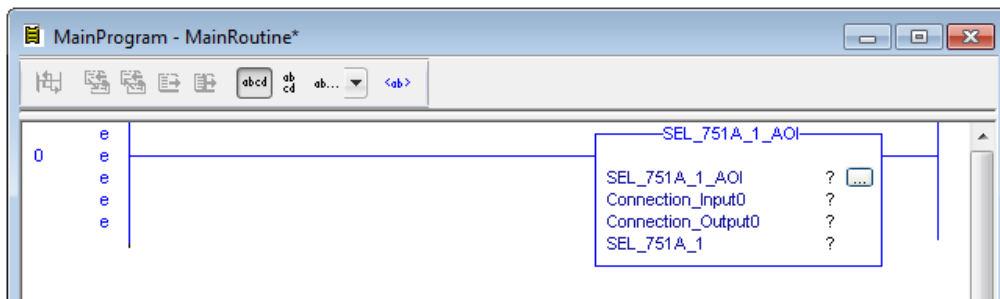

- 4 Select the AOI input tags (in this example SEL_751A_1_AOI), then right-click the ? and choose **NEW TAG**.

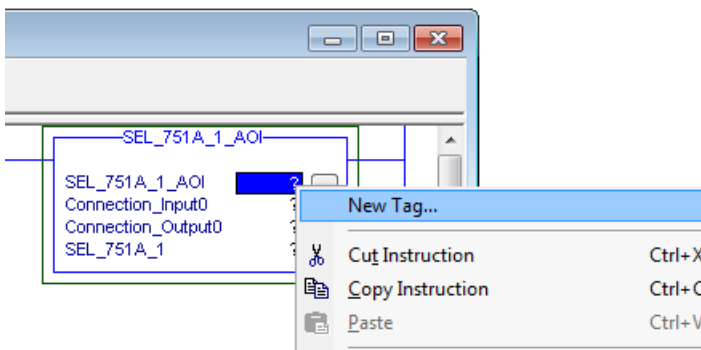

- 5 The New Tag dialog box appears. Enter a **NAME** for the Add-On Instruction and then click **CREATE**.

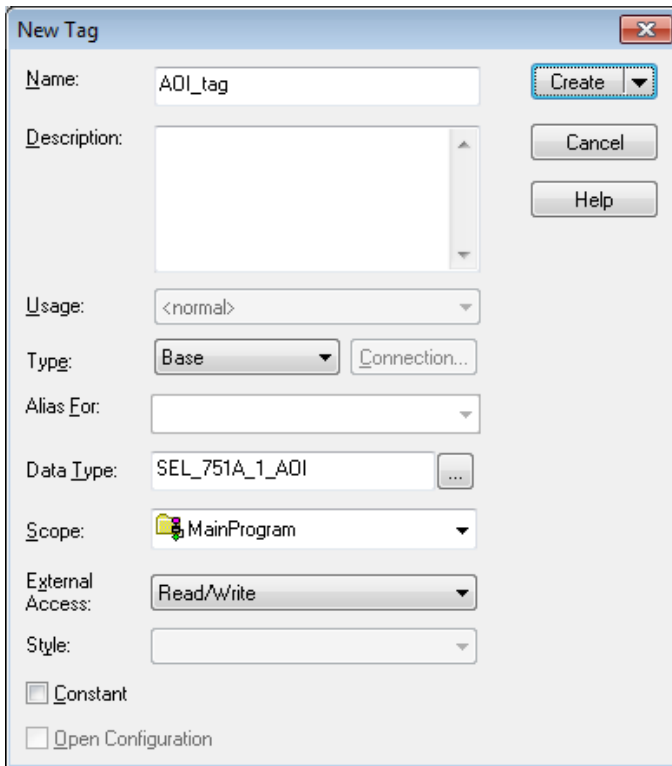

This method of generating the new tag automatically selects the proper **DATA TYPE** needed for the Add-On Instruction, eliminating possible data type errors.

3.7 Mapping to the Generic Ethernet Bridge

- 1 Double-click the ? (question mark) next to **CONNECTION_INPUT0**, and then click the drop-down arrow that replaces the question mark.
- 2 Configure the **CONNECTION_INPUT** parameter to map to the gateway that you created in Adding the Gateway (page 45) to the Add-On Instruction as shown below.

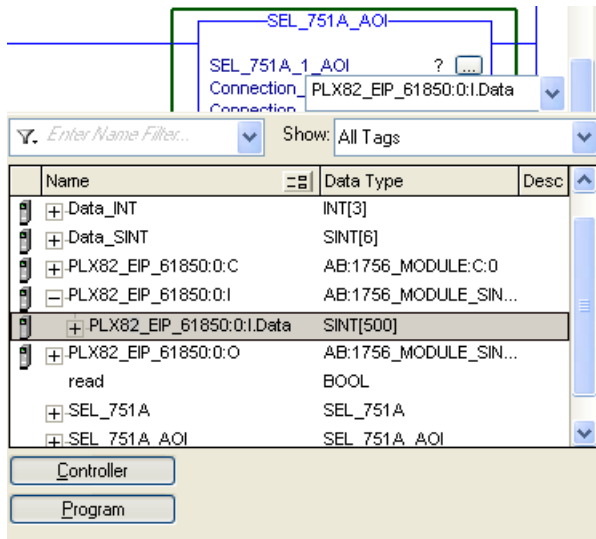

- 3 Configure the **CONNECTION_OUTPUT** in the same way.

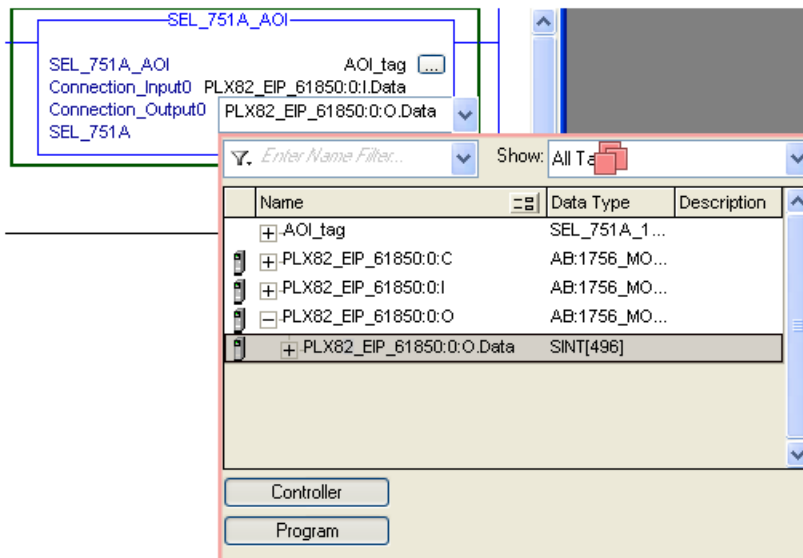

- 4 Right-click the data tag of the Add-On Instruction and choose **NEW TAG...**

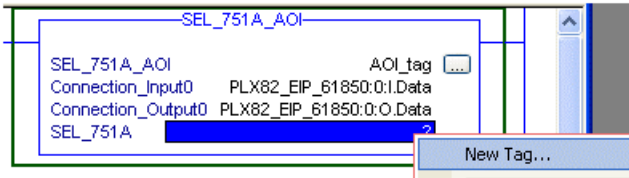

- 5 Select a tag name for the data portion of the Add-On Instruction (SEL_751A_1_data in this example). Click **CREATE** to build the new data tag.

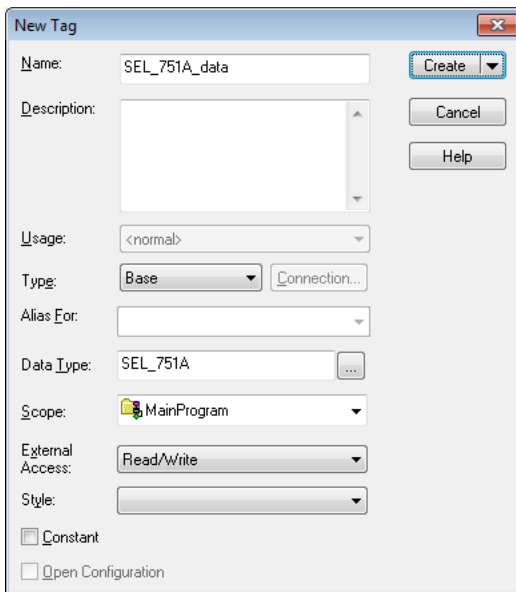

- 6 RSLogix verifies the rung, after which the run appears in the *MainRoutine* window.

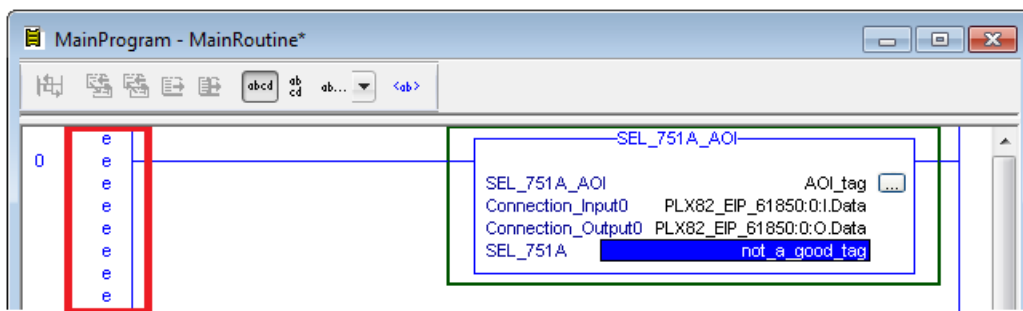

Note: If "eeee" appears to the left of the rung, then there is an error in the rung configuration. Review the above steps to make sure the configuration is correct.

3.8 Importing an updated AOI from an updated IED

You may need to make changes to the CID, ICD, or SCD files after you complete the project in RSLogix 5000. For example, you may need to modify a DATA-SET, or add or remove some Data Attributes. You would first update the project in the ProSoft EIP-61850 Configuration Manager with the new information. Refer to Importing Updated IED Files (page 40). The last step in that process is creating an updated Add-On Instruction (AOI) file for the updated IED.

After you have created the updated AOI file or files, you then import them into RSLogix 5000 to update your project.

Follow the same steps in Import the AOI from the Configuration Manager (page 49), with one critical difference: in the *Import Configuration* window.

- 1 Select **DATA TYPES** in the **IMPORT CONTENT** tree.
- 2 Select **OVERWRITE** in the **OPERATION** column under **CONFIGURE DATA TYPE REFERENCES**.

If you have added new data parameters to the IEC 61850 configuration, selecting Overwrite ensures that importing the new Add-On Instruction imports the new User Defined Data Type required.

- 3 Complete the process as described in Import the AOI from the Configuration Manager (page 49).

3.9 Configuring Class 3 MSG Instructions

There are two ways for a PLC to read and write to the PLX82-EIP-61850:

- CIP Data Table Read/Write
- CIP Generic Get/Set Attribute

Note: Please see *Driver Status Data* on page 63 for EtherNet/IP Connection status, IED Node status, and Module Driver status details.

1 Using a Class 3 MSG instruction, a PLC can read from the PLX82-EIP-61850.

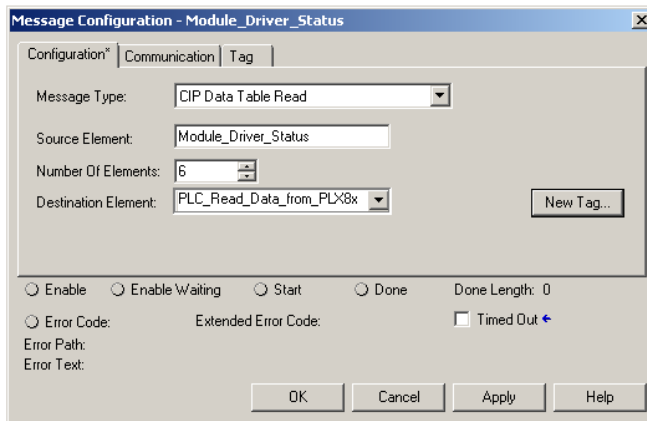

2 In the *Configuration* tab, fill in the values for the following parameters:

Parameter	Description
Message Type	CIP DATA TABLE READ
Source Element	The PLX82-EIP-61850 tag name in which the data is referenced. 1. In ProSoft EIP-61850 Configuration Manager, open the <i>EtherNet/IP Mapping</i> window and click on the <i>Class 3 MSGs</i> tab. 2. Locate the <i>Tag Name</i> column. The available tags to read from the PLX82-EIP-61850 example are circled in red below. Notice the corresponding <i>Access</i> column values of R - indicating 'Read-Only'.
Number of Elements	Number of bytes to read from the PLX82-EIP-61850. This can be found in the <i>Bytes</i> column of the <i>Tag Name</i> listing.
Destination Element	The PLC Controller Tag name to place the incoming data. It must contain enough members based on the size of the data to obtain from the PLX82-EIP-61850.

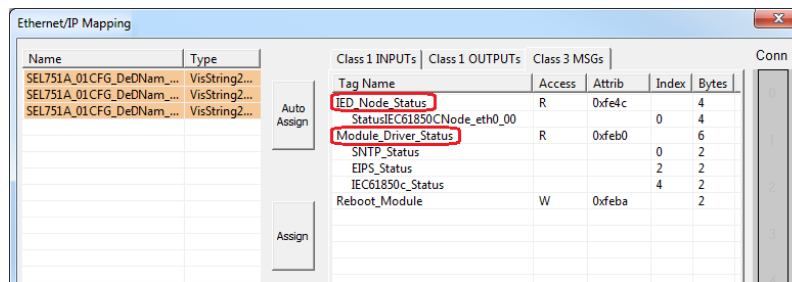

3 When complete, click **APPLY** then click **OK**.

3.9.1 CIP Data Table Write

- Using a Class 3 MSG instruction, a PLC can write value(s) to the PLX82-EIP-61850.

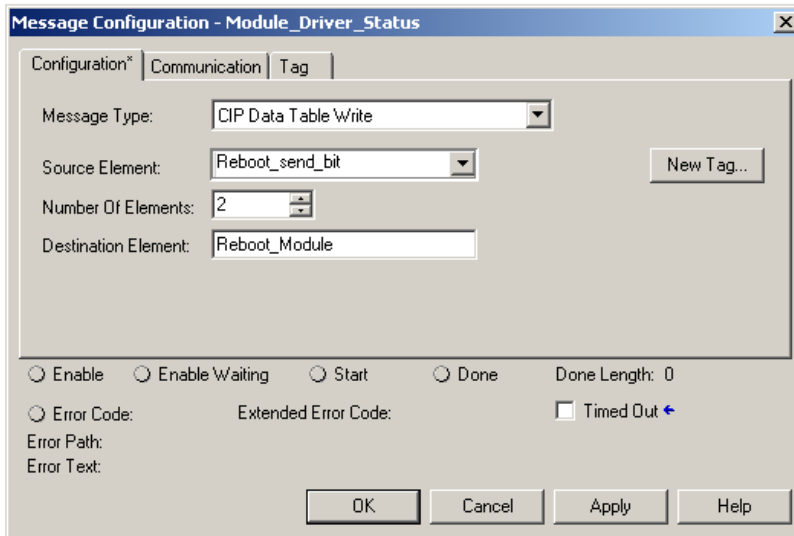

- In the *Configuration* tab, fill in the values for the following parameters:

Parameter	Description
Message Type	CIP DATA TABLE WRITE
Source Element	The PLC Controller Tag name in which the data is referenced.
Number of Elements	Number of bytes to write to the PLX82-EIP-61850. This can be found in the <i>Bytes</i> column of the <i>Tag Name</i> listing.
Destination Element	The PLX82-EIP-61850 tag name in which the data will be written to. 1. In ProSoft EIP-61850 Configuration Manager, open the <i>EtherNet/IP Mapping</i> window and click on the <i>Class 3 MSGs</i> tab.

2. Locate the *Tag Name* column. The available tag to write to the PLX82-EIP-61850 example is circled in red below. Notice the corresponding *Access* column value of **W** - indicating 'Write-Only'.

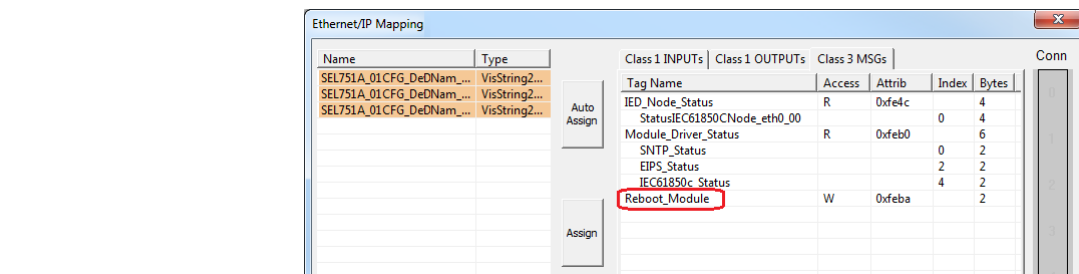

- 3 In the *Communication* tab, make sure the **CONNECTED** and **CACHE CONNECTIONS** boxes are checked.

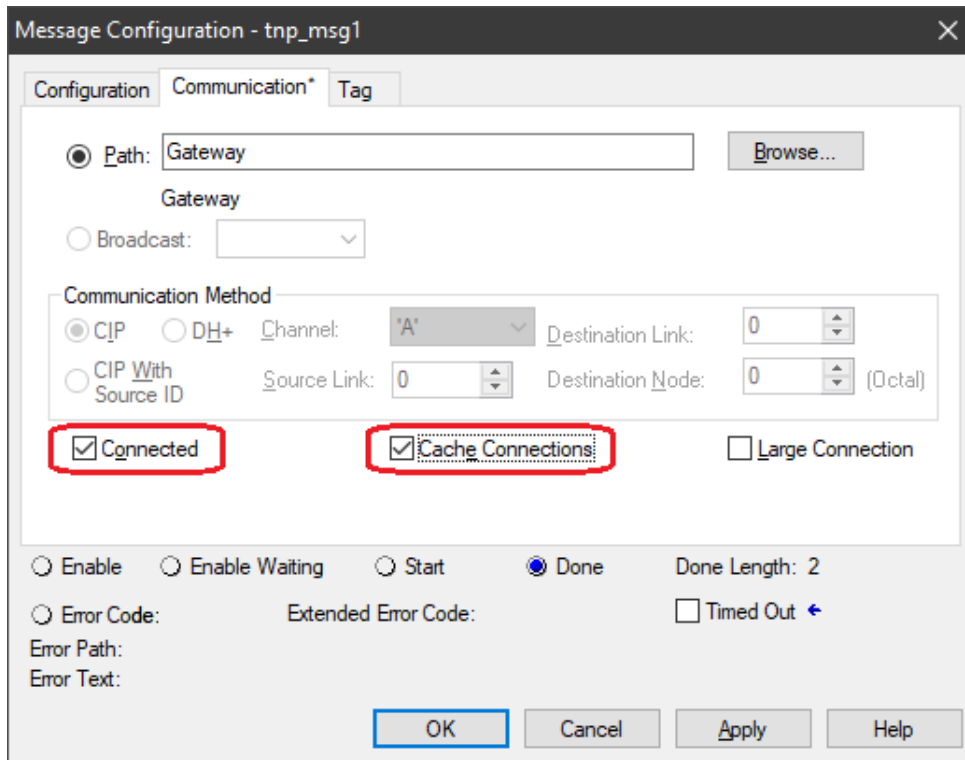

- 4 When complete, click **APPLY** then click **OK**.

3.9.2 CIP Generic Get Attribute Single

- Using a Class 3 MSG instruction, a PLC can read value(s) from the PLX82-EIP-61850.

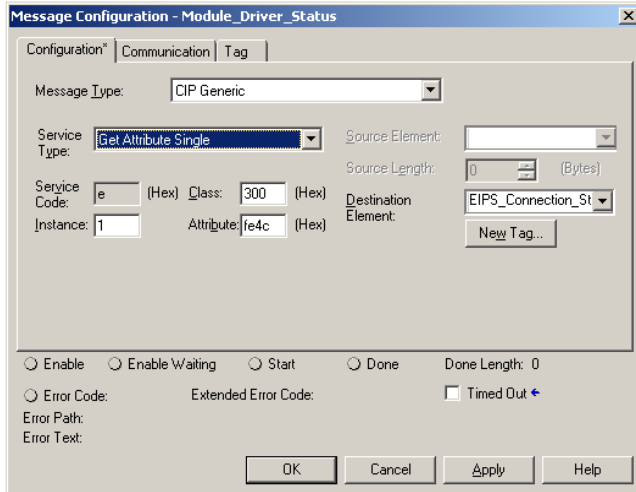

- In the *Configuration* tab, fill in the values for the following parameters:

Parameter	Description
Message Type	CIP Generic
Service Type	Get Attribute Single
Service Code	E
Class (Hex)	300
Instance	1

Attribute (Hex) Data source location as defined in ProSoft EIP-61850 Configuration Manager. The hexadecimal Attribute values are found here in ProSoft EIP-61850 Configuration Manager:
 1. In ProSoft EIP-61850 Configuration Manager, open the *EtherNet/IP Mapping* window and click on the *Class 3 MSGs* tab.

2. Locate the tag name and its corresponding *Attrib* value in hexadecimal format. The Attribute values are circled in red below. Notice the corresponding *Access* column values of **R** - indicating 'Read-Only'.

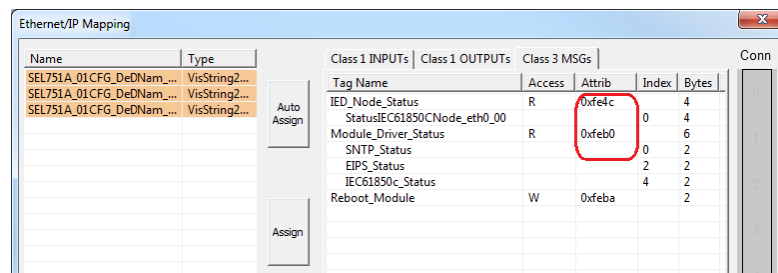

Source Element	N/A
Source Length	N/A
Destination Element	PLC Controller tag name used to store the incoming data.

- When complete, click **APPLY** then click **OK**.

3.9.3 CIP Generic Set Attribute Single

- Using a Class 3 MSG instruction, a PLC can write value(s) to the PLX82-EIP-61850.

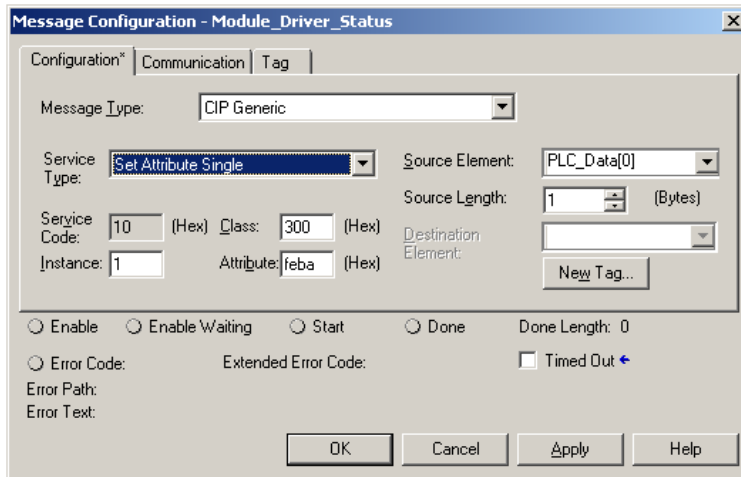

- In the *Configuration* tab, fill in the values for the following parameters:

Parameter	Description
Message Type	CIP Generic
Service Type	Set Attribute Single
Service Code	10
Class (Hex)	300
Instance	1
Attribute (Hex)	Data destination location as defined in ProSoft EIP-61850 Configuration Manager. The hexadecimal Attribute values are found here in ProSoft EIP-61850 Configuration Manager:

- In ProSoft EIP-61850 Configuration Manager, open the *EtherNet/IP Mapping* window and click on the *Class 3 MSGs* tab.
- Locate the tag name and its corresponding *Attrib* value in hexadecimal format. The Attribute value is circled in red below. Notice the corresponding *Access* column value of **W** - indicating 'Write-Only'.

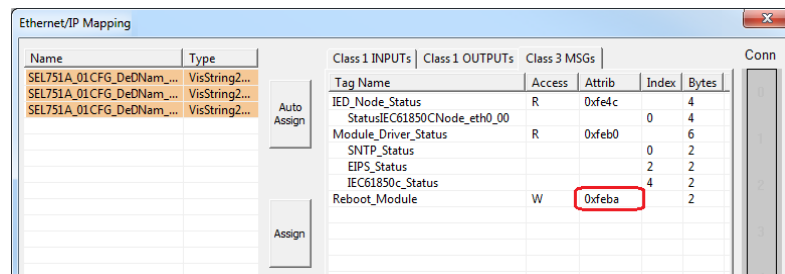

Source Element	PLC Controller tag array in which the data is sourced
Source Length	1
Destination Element	N/A

- When complete, click **APPLY** then click **OK**.

4 Diagnostics and Troubleshooting

There are two ways to troubleshoot this PLX82-EIP-61850 gateway:

- Use the LEDs located on the front of the gateway.
- Use the Debug port (Ethernet port E1) that provides a view into the gateway's internal database.

4.1 Known Anomalies

In the unlikely event that an IED on the network causes a large number of reconnects to the gateway, the 61850 driver in the gateway eventually restarts, causing re-initialization of the communication between the gateway and all the IEDs on the network. Until all the IEDs connected on the network have been reinitiated, the data in the gateway database being transferred through the gateway's EtherNet/IP is not being updated. To help you detect this condition, there are status bits available that you can effectively use in the program in the PLC for tracking. Refer to *Driver Status Data* on page 63.

4.2 Important Design Considerations

When utilizing any type of gateway device, take care to make sure that in the event in loss of communications between devices on either driver in the gateway (the 61850 driver to the IEDs or the EtherNet/IP driver to the processor), this loss of communications is passed to the other driver.

For example, suppose there is a loss of communications with an IED device on the 61850 network. This information is shared with the EtherNet/IP device, so that the device can make an informed decision to trigger any type of alarm or fail safe state for the attached device.

All applications should also consider each of the status words available to the various drivers. No application should be configured into a live system without mapping the driver status words and IEC 61850 IED status registers as described in *Driver Status Data* (page 63).

Additionally, if a EtherNet/IP scanner (such as a ControlLogix or CompactLogix PLC) is issuing control commands to the gateway as a EtherNet/IP server, then that device should also monitor the gateway's status information to make sure that this information is written to the gateway.

Reporting this status information is crucial to the set-up and configuration of a live system. Without mapping status data to the various drivers, it is impossible to tell if communications is actively occurring with the device, or if the data values are stale, and simply represent the last known conditions of that device before the communication failure.

Driver status, IED status, and client/server status information should be shared with the various drivers to ensure that a clear indication of the loss of communications can be signaled to the devices on the network.

4.3 Driver Status Data

The driver status data includes status registers, displayed on the Class 3 MSGs tab of the EtherNet/IP Mapping window. The values are always available and can be read from the gateway by the PLC with a Class 3 MSG instruction. For more information, please see *Configuring Class 3 MSG Instructions* on page 57.

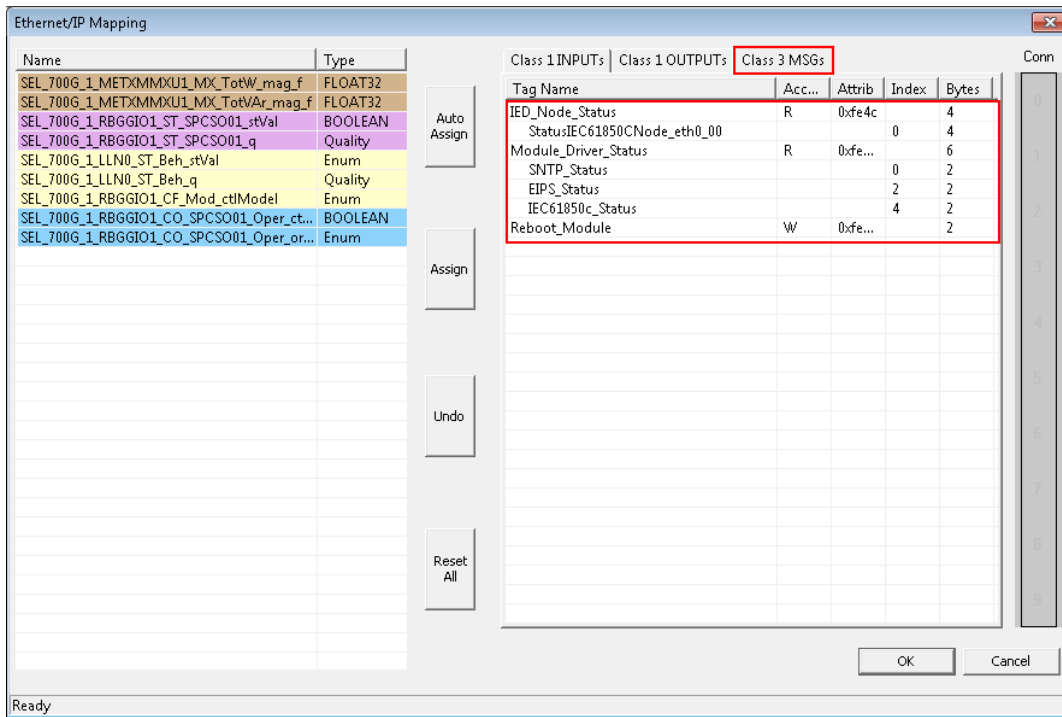

The PLC can read the value by polling for the tag names *EIPS_Connection_Status*, *IED_Node_Status*, or *Module_Driver_Status* using a Class 3 MSG instruction as shown below (in RSLogix 5000).

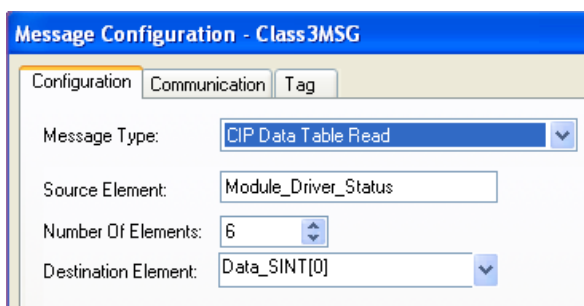

The **DESTINATION ELEMENT** of the RSLogix 5000 MSG instruction should be of data type SINT. The **DESTINATION ELEMENT** must contain enough members based on the size of the data to obtain from the gateway.

Alternatively, you can configure a MSG instruction to poll for Class 0x300 Instance 0x01 and Attribute (as listed in the Class 3 MSGs tab). Below is a sample MSG configuration using Class, Instance, Attribute messaging.

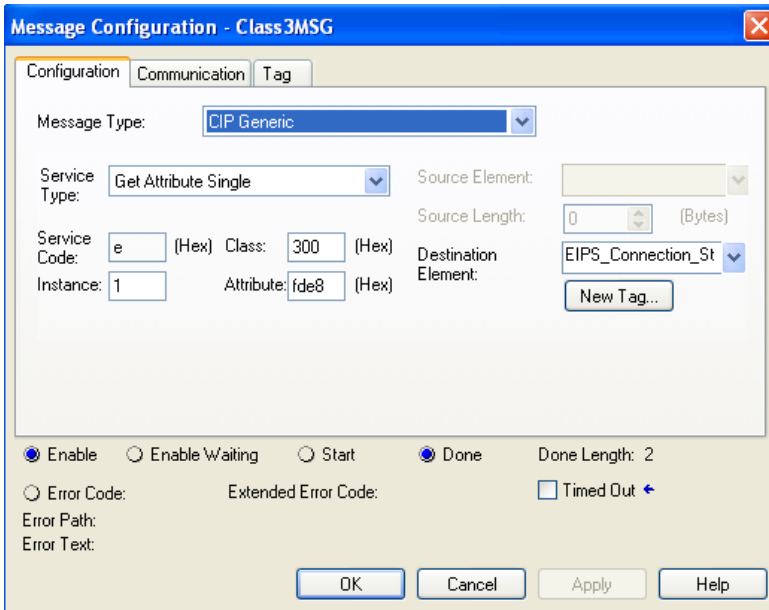

4.3.1 Status Values

The Driver Status Register possible values are:

Value	Description
-2	Node in error (MMS read or write failed)
1	OK
0	Failed or Driver startup/restart is occurring

Tag Name	Description	
EIPS_Connection_Status (Read Only)	Class1 Reconnection Count. Increments on each connection attempt. Data Type: INT (32767 max)	
Connection0	INT	
Connection1	INT	
Connection2	INT	
...		
Connection19	INT	
IED_Node_Status (Read Only)	1 = OK, 0 = Issue with Node Data Type: DINT (1 max)	
IED # 1	SINT[0]	1
	SINT[1]	0
	SINT[2]	0
	SINT[3]	0
IED # 2	SINT[4]	1
	SINT[5]	0
	SINT[6]	0
	SINT[7]	0
IED # 3	SINT[8]	1
	SINT[9]	0
	SINT[10]	0
	SINT[11]	0
...		
IED # 20	SINT[76]	1
	SINT[77]	0
	SINT[78]	0
	SINT[79]	0
Module_Driver_Status (Read Only)	1 = OK, 0 = Failed or Driver startup/restart is occurring Data Type: INT (1 max)	
SNTP Status	SINT[0]	1
	SINT[1]	0
EIP Status	SINT[2]	1
	SINT[3]	0
IEC61850 Status	SINT[4]	1
	SINT[5]	0

4.4 Rebooting the Gateway

There are several ways to reboot the gateway.

- Disconnect and reconnect power from the gateway.
- From the PLC, write to the Reboot_Module tag. This causes the gateway to reboot. Below shows the Reboot_Module tag in the EtherNet/IP Mapping window in the ProSoft EIP-68150 Configuration Manager.

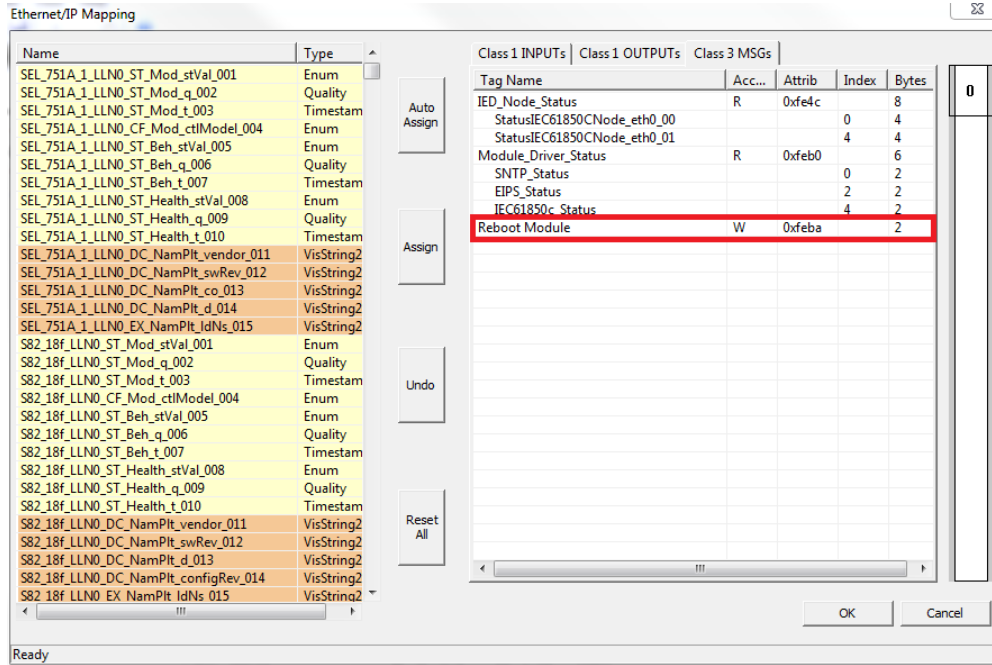

- From the gateway webpage, use the Reboot Gateway feature. Refer to Web Service and Gateway Webpage (page 77).

Note: The gateway reboots automatically after you download a new configuration file to the gateway.

Tag Name	Description	
Reboot_Module (Write Only)	1=Reboot Data Type: INT (1 max)	
Reboot_Module	SINT[0]	1
Reboot_Module	SINT[1]	0

4.5 ProSoft EIP-61850 Tag Monitor Diagnostics

- 1 To start ProSoft EIP-61850 Tag Monitor, choose **Start > Programs > ProSoft Technology > ProSoft EIP-61850 Tag Monitor**.
- 2 The ProSoft EIP-61850 Tag Monitor requests the gateway’s IP address upon start-up.

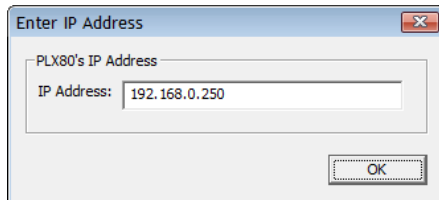

Once ProSoft EIP-61850 Tag Monitor locates the gateway, it displays information about the tags in the gateway’s tag database. ProSoft EIP-61850 Tag Monitor allows you to change the values of a tag through the *Value* field. Data movement from the devices connected to the gateway may overwrite any values that were provided on this window. Here is the ProSoft EIP-61850 Tag Monitor window.

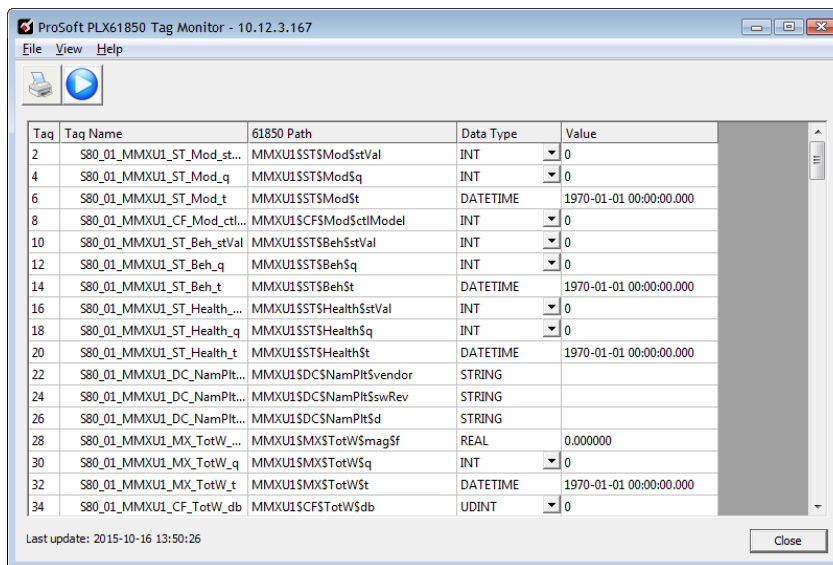

The window shows three columns of data: **TAG NAME**, **DATA TYPE**, and **VALUE**. Tag names for complex data types show a + to the left of the name. The gateway considers some of the IEC 61850 data types to be complex. In the window shown here, see Tag Name S40_1r_RREC1_CO_BlKRec_Oper_003.

In this example, this Tag Name is mapped to IEC 61850 Path RREC1\$CO\$BlKRec\$Oper\$origin\$orIdent. The IEC 61850 Standard identifies *orIdent* as the originator identification, and shows the address of the originator who caused the change of the value. Data for which there are several levels of hierarchy are considered complex, as well as some longer data types. The data type orIdent is Octet64.

To print the data:

Click the Print button to print the current data.

To start/stop data update:

Click the Start/Stop button to start or stop updating the data. Note that the appearance of this button changes when you toggle between start and stop.

Note: All Tag Monitor functions require that you install the MODE 3 jumper on the module. Refer to Setting Jumpers (page 9).

4.6 ProSoft 61850 Configuration Manager Diagnostics

4.6.1 IEC 61850 Client Diagnostics

The following sets of IEC 61850 client diagnostics data are available from the gateway:

- Configuration Settings
- Driver Status
- Remote Node Config
- Remote Node Status
- Report Status
- GOOSE Subscription Status

Configuration Settings

The following Configuration Settings diagnostic data is available from the gateway.

Value	Description
TimeOut	The value in seconds for the command to timeout from a request.
GOOSE Support	TRUE or FALSE value, indicating if GOOSE messaging is supported and configured on the gateway.
Sampled Values Support	TRUE or FALSE value, indicating if Sampled Values is supported and configured on the gateway.
Number of Remote Addresses	The count of remote addresses present in the current operating configuration of the gateway, in the IEC-61850 driver.
Reports Configured	TRUE or FALSE value in driver indicating if reports are currently configured in the IEC-61850 driver.
Number of Commands	The total count of Read and Write commands present in the current operating configuration of the IEC-61850 driver.
Number of GOOSE Subscriptions	The total count of GOOSE subscriptions present in the current operating configuration of the IEC-61850 driver.
Number of Reports Configured	The total count of reports (Buffered and Unbuffered) present in the current operating configuration of the IEC-61850 driver.

Driver Status

The following Driver Status diagnostic data is available from the gateway.

Value	Description
Remote Node Status	This displays a bitmap of 1s or 0s, to indicate the communication status of each IED where 1=communication is good, and 0=no communication.
Command Read Requests	The count of total IEC61850 (MMS type) read command requests sent to nodes defined in the configuration file.
Command Write Requests	The count of total IEC61850 (MMS type) write command requests sent to nodes defined in the configuration file.
Command Read Errors	The count of total IEC61850 (MMS type) read errors received from requests sent to nodes defined in the configuration file.
Command Write Errors	The count of total IEC61850 (MMS type) write errors received from requests sent to nodes defined in the configuration file.
GOOSE messages Processed	The total count of GOOSE messages received per all subscriptions defined in the current operating configuration of the IEC61850 driver.
Report Messages Processed	The total count of reports received per all reports that are enabled, and present in the current operating configuration of the IEC61850 driver.
Identification Response Errors	The total count of Identification response errors per the nodes/devices defined in the current operating configuration of the IEC61850 driver.
Create DataType Errors	The total count of errors received when making a request for datatypes defined for the configured commands in the current operating configuration of the IEC61850 driver.

Remote Node Config

Command	Description
Remote Node Configured Index, or (Not Configured)	Value is the current index used of the addressed node, indicating that the node is configured in the current operating configuration file... or the value indicates that the node is not configured.
Remote Node IP Address	The IP Address of the indexed node being requested that is defined in the configuration file.
Remote Node Name	The Node Name identifier of the indexed node being requested that is defined in the configuration file.
Command Index Entry(s)	Lists the commands defined in the config file for the indexed node being requested, where each command entry is defined with this start tag to identify the command with a unique entry index used.
Command Domain Name	Identifies the Domain Name used when accessing the IEC61850 variable via the command entry index in the returned information.
Command Datapath Name	Identifies the Datapath Name used when accessing the IEC61850 Data Attribute via the command entry index in the previously returned information.
Command Tagname(s)	Identifies the gateway's tagnames for the command, which are allocated in the current operating configuration file for the indexed command entry.
GOOSE Index Entry(s)	Lists the GOOSE subscriptions defined in the configuration file for indexed node being requested, where each GOOSE subscription is defined with this start tag to identify the GOOSE subscription unique entry index.
Data Set Reference	Identifies the DATA-SET Reference used when receiving the GOOSE message.

Command	Description
GOOSE CB Reference	Identifies the GOOSE Control Block Reference used on the remote node for this specific GOOSE Subscription indexed entry.
Application ID	Identifies the Application ID used on the remote node for this specific GOOSE subscription indexed entry.
Multicast Address	Identifies the Multicast Address used on the remote node for this specific GOOSE subscription indexed entry.
Configuration Revision	Identifies the Configuration Revision used on the remote node for this specific GOOSE subscription indexed entry.
Decode Mode	Identifies the Decode Mode used on the remote node for this specific GOOSE subscription indexed entry. Implemented to use Decode Mode Immediate. Could be flexible in the future if required.
GOOSE Domain Name Entry	The domain name entry for each of the data objects specified in the DATA-SET used by the GOOSE subscription.
GOOSE Data Ref Entry(s)	The data reference entry for each of the data objects specified in the DATA-SET used by the GOOSE subscription.
Report Index Entry(s)	Lists the reports defined in the configuration file for indexed node being requested, where each report is defined with this start tag to identify the report with a unique entry index.
Report Domain Name Entry	The domain name entry for the report control block specified along with the DATA-SET used by the report, in order to accurately decode the reported message to the ProSoft module's Tag Database Tags.
Report Data Reference Entry	The data reference entry for the report control block specified along with the DATA-SET used by the report, in order to accurately decode the reported message to the Tag Database.
Report ID	The report ID associated with this Report Entry.
# of Tags Associated w/ Report	The number of tags associated with this report entry in the Tag database.

Remote Node Status

Command	Description
Remote Node Status 0	Indicates if the remote node for this index is configured or not. If the remote node is configured the unique index is included to indicate the reference start of the following for the status information.
Remote Node IP Address	The IP Address used by the remote node for this index.
Remote Node Name	The remote node name used by the remote node for this index.
Remote Node Vendor	The Vendor that manufactures the remote node for this index.
Remote Node Model	The Model Number used by the remote node for this index.
Remote Node Revision	The revision used by the remote node for this index.
Remote IED Command Status	Lists the commands by individual unique index as corresponding to the current operating configuration in the gateway, in which the following data are returned to indicate the command status.

Report Status

Command	Name	Description
Command Status Entry(s) LIST...	Command Status List []... for each command entry...	Lists the commands by individual unique index as corresponding to the current operating configuration in the ProSoft module, in which the following data are returned to indicate the command status.
Current Command Status	<currentstatus value = "" description = "" />	Indicates the last available status of the command sent to the remote node and the result, being either "OK" or "ERR".
Command Total Error Count	<cmderrcount value = "" description = "" />	Indicates the total error count for this unique command as it was processed by the IEC-61850 drive.
Report Status Entry(s) LIST...	Report Status List []... for each report entry...	Lists the reports by individual unique index as corresponding to the current operating configuration, in which the following data are returned to indicate the report received count.
Report Status Entry	<rptindex value = "" description = "" />	Lists the report control block status by individual unique index as corresponding to the current operating configuration.
Reports Received Count	<rptcount value = "" description = "" />	Indicates the total report received count for this unique report as it was processed by the PLX82 IEC-61850 driver.

GOOSE Subscription Status

Command	Description
GOOSE Status Entry	An individual unique index as corresponding to the current operating configuration, in which the following data are returned to indicate the GOOSE Message received count.
Goose Messages Received Count	Indicates the total GOOSE message received count for this unique GOOSE subscription as it was processed by the IED 61850 driver. It has been observed that sometimes this number shows fewer than expected.

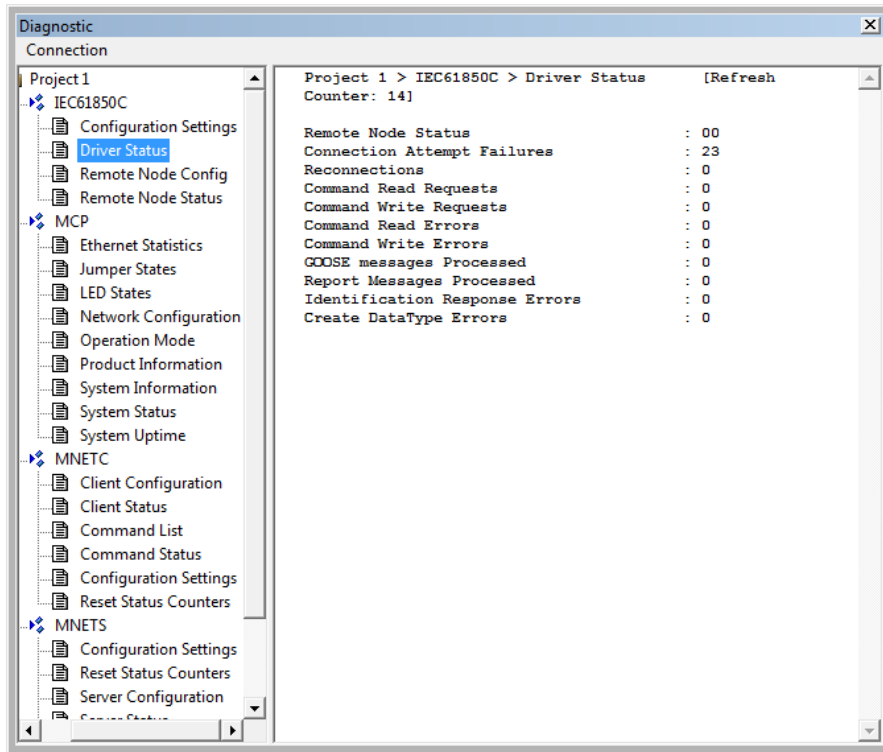

If the gateway loses connection with the IED but is able to reconnect then the *Reconnections* value reads 1. If it is not able to reconnect then the value reads 0.

4.6.2 MCP Diagnostics

The following MCP (internal gateway) diagnostic data is available from the gateway:

- Ethernet Statistics
- Jumper States
- LED States
- Network Configuration
- Operation Mode
- Product Information
- System Information
- System Status
- System Uptime

Ethernet Statistics

Function	Description
RX Bytes	Total received byte count.
RX Packets	Total number of received Ethernet packets.
TX Bytes	Total number of transmitted bytes.
TX Packets	Total number of transmitted Ethernet packets.

Jumper States

Jumper Name	States	Description
Setup (MODE 3)	ON or OFF	Note: While this jumper is removed 'OFF', all webpages are disabled on the module. It is recommended that the setup jumper be removed for normal operation, as webpage activity may interfere with the EtherNet/IP or IEC 61850 communications.
Default IP	ON or OFF	
Reserved	ON or OFF	

LED States

State	Description
Error	ON or OFF. This is the ERR LED above the power connector.
Config	ON or OFF. This is the CFG LED above the power connector.
Fault	ON or OFF. This is the FLT LED above the power connector.
ms	OFF. This is not used by the PLX82-EIP-61850.
ns	OFF. This is not used by the PLX82-EIP-61850.

Network Configuration

Function	Description
IP Address	This is the gateway's configured IP address you entered in ProSoft EIP-61850 Configuration Manager.
Network Mask	This is the gateway's configured network mask you entered.
Gateway	This is the gateway's configured gateway you entered.

Operation Mode

Values may be:

- Init
- Start
- Ready
- Run
- Stop
- Restart
- Shutdown
- Done

Product Information

Field	Description
Product Type	Gateway
Product Name	PLX82-EIP-61850
Module Name	This the gateway gateway's name that you entered in the <i>Gateway Configuration</i> window.
Product Version	This is the version of the PLX82-EIP-61850.
MAC Address	This is the MAC address of the gateway.
Serial Number	This is the Serial Number of the gateway.

System Information

Version: This is the version of the PLX82-EIP-61850 product.

System Status

This shows the setting of the **FLT** LED. Values shown here may be **OK** and **FLT** (meaning **fault**).

System Uptime

The total system uptime is number of days plus number of hours plus number of minutes plus number of seconds.

Value	Description
Days	Number of days the gateway has been operating since the last power-up.
Hours	Number of hours the gateway has been operating since the last power-up.
Minutes	Number of minutes the gateway has been operating since the last power-up.
Seconds	Number of seconds the gateway has been operating since the last power-up.

4.6.3 EtherNet/IP Diagnostics

The following EtherNet/IP diagnostic data is available from the gateway:

- Class 1 Configuration
- Class 1 Connection Status
- Class 3 Configuration
- Class 3 Connection Status
- Configuration Settings
- Driver Status

Class 1 (Implicit) Configuration

The following Class 1 Configuration diagnostic data is available from the gateway.

Function	Description
Class 1 (Implicit) Input Connections	This indicates if a Class 1 Input connection to the PLC is active or inactive.
Class 1 (Implicit) Output Connections	This indicates if a Class 1 Output connection to the PLC is active or inactive.

Class 1 (Implicit) Connection Status

The following Class 1 Connection Status diagnostics data is available from the gateway.

Value	Description
Class 1 (Implicit) Input Status	This indicates if a Class 1 Input connection to the PLC is active or inactive.
Class 1 (Implicit) Output Status	This indicates if a Class 1 Output connection to the PLC is active or inactive.

Class 3 (Explicit) Configuration

The following Class 3 Configuration diagnostic data is available from the gateway.

Value	Description
Tagname Configured – Attribute Value	This shows the attribute value for each mapped tag name.

Class 3 (Explicit) Connection Status

The following Class 1 Connection Status diagnostics data is available from the gateway.

Value	Description
Tagname Configured – Message Count	This indicates the number of times each tag is accessed.

Configuration Settings

The following Configuration Settings diagnostic data is available from the gateway.

Value	Description
Number of Class 1 (Implicit) Connections Configured	This indicates if a Class 1 Input connection to the PLC is active or inactive.
Number of Class 3 (Explicit) Tags Configured	This indicates if a Class 1 Output connection to the PLC is active or inactive
Class 3 (Explicit) Class Id Used	This indicates the Class used for Class/Instance/Attribute access.
Class 3 (Explicit) Instance Id Used	This indicates the Instance used for Class/Instance/Attribute access.

Driver Status

The following Driver Status diagnostic data is available from the gateway.

Value	Description
EIPS Driver Status	This indicates the health of the EIP driver.
Class 1 (Implicit) Established Connection Count	This lists the number of connections established for each Class 1 connection.
Class 3 (Explicit) Message Status	This indicates the number of Class 3 Requests, Responses and Error Requests.

4.6.4 SNTP/NTP

Status

The following SNTP/NTP Status diagnostics data is available from the gateway.

Value	Description
Time from SNTP/NTP server	This shows the time retrieved from the SNTP/NTP server.

Poll Count

The following Poll Count diagnostics data is available from the gateway.

Value	Description
Clock Update Count	This displays the number of times the gateway's clock has been updated.
Error Count	This is the number of unsuccessful times the gateway has attempted to reach the SNTP/ NTP Server.

Configuration Settings

The following Configuration Settings diagnostic data is available from the gateway.

Value	Description
Update rate in Minutes	How frequently the time is synchronized via SNTP/NTP. This is a configured value that is set on the Gateway Configuration window, in the SNTP/NTP Update Time field.
Server Address	The IP address or domain name for the SNTP/NTP server. This is a configured value that is set on the Gateway Configuration window, in the SNTP/NTP Address field.

Driver Status

The following Driver Status diagnostic data is available from the gateway.

Value	Description
Status	This is the result of the latest poll. Values are OK or Error retrieving time from SNTP/NTP server.
Poll Count	This is the number of update attempts (at the configured frequency) since startup (unsigned long rolls over at 4 billion plus). If Poll Count is zero (before first attempt, or configured update time is 0 for never poll) Status is OK.

4.7 Web Service and Gateway Webpage

When the gateway's IP address is accessed through a browser (such as Internet Explorer) or through ProSoft Discovery Service, it shows the gateway's webpage. The gateway's Web Services are connection-based, and therefore can accept multiple connections at a time. Multiple users can view the gateway's webpage at the same time.

Note: In order to access the web server the module must be booted with the MODE 3 jumper on. If the module is booted with the MODE 3 jumper removed, the web server is not started. Removing the setup jumper and restarting after configuring the module or accessing the webpage helps prevent performance degradation from web server access while in run mode. Refer to Setting Jumpers (page 9).

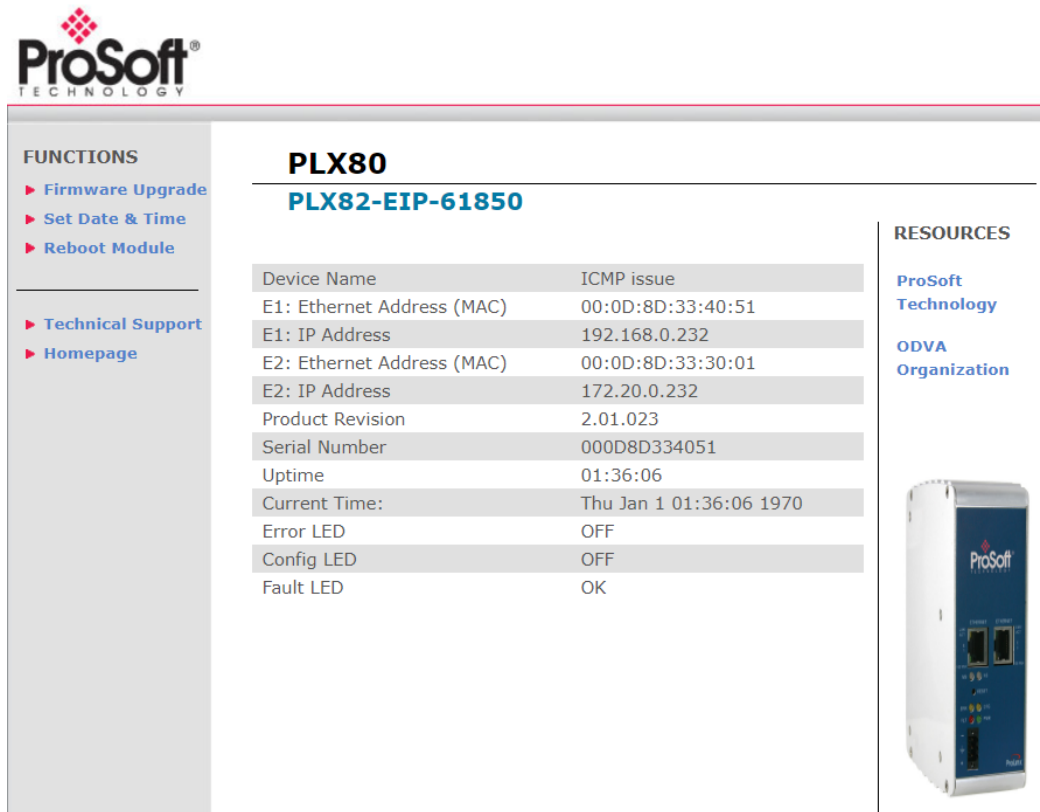

The screenshot displays the ProSoft Technology logo at the top left. Below it is a navigation menu with 'FUNCTIONS' and 'RESOURCES' sections. The main content area is titled 'PLX80' and 'PLX82-EIP-61850'. It features a table of system information and a photograph of the physical gateway device on the right.

PLX80	
PLX82-EIP-61850	
Device Name	ICMP issue
E1: Ethernet Address (MAC)	00:0D:8D:33:40:51
E1: IP Address	192.168.0.232
E2: Ethernet Address (MAC)	00:0D:8D:33:30:01
E2: IP Address	172.20.0.232
Product Revision	2.01.023
Serial Number	000D8D334051
Uptime	01:36:06
Current Time:	Thu Jan 1 01:36:06 1970
Error LED	OFF
Config LED	OFF
Fault LED	OK

FUNCTIONS

- ▶ Firmware Upgrade
- ▶ Set Date & Time
- ▶ Reboot Module

- ▶ Technical Support
- ▶ Homepage

RESOURCES

- ProSoft Technology
- ODVA Organization



Functions

Parameter	Description
Firmware Upgrade	Click to upgrade the firmware in the gateway. Only do this if instructed to do so by ProSoft Technology Technical Support.
Set Date & Time	Click to set the date and time in the gateway.
Reboot Module	Click reboot the gateway.
Technical Support	Click to be directed to the ProSoft Technology Technical Support website.
Homepage	Click to go to the gateway's homepage (shown above).

Resources

Parameter	Description
ProSoft Technology	Click to be directed to ProSoft Technology's Website.
ODVA Organization	Click to be directed to the ODVA website.

The following information is shown on the Home Page of the gateway Webpage:

Parameter	Description
Device Name	The Project Name you set in the ProSoft EIP-61850 Configuration Manager.
Ethernet Address (MAC)	The gateway's MAC address.
IP Address	The gateway's IP Address.
Product Revision	The product revision number, determined by the version number of the firmware currently in the gateway.
Serial Number	The gateway's serial number.
Uptime	The number of hours, minutes, and seconds that the gateway has been "up" or "alive" since the last reboot or reconnection of power.
Current Time	The gateway's current time. You can change the gateway's time by using SNTP as described in Configuring the Gateway EtherNet/IP Adapter (page 16), or by choosing Functions / Set Date & Time on the gateway's webpage.
Error LED	ON or OFF. This is the ERR LED above the power connector.
Config LED	ON or OFF. This is the CFG LED above the power connector.
Fault LED	OK or ON. This is the FLT LED above the power connector.

4.8 Event Logger

The gateway’s internal processes and drivers write event log data to the Event Logger. You can access the Event Logger from ProSoft EIP-61850 Configuration Manager by right-clicking the **PROSOFT GATEWAY** bubble, and choosing **EVENT LOGGER**.

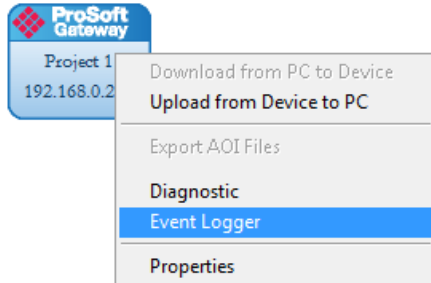

The data written to the *Event Logger* is:

- Event Level
- Date & Time
- Resource
- Driver
- Error Message

Here are the possible Event Levels and their descriptions:

Event	Description
DEBUG	Very detailed debug data to the event log that needed to help ProSoft Technical Support
INFO	Potential problem, but not an error
WARNING	Potential problem, but not an error
ERROR	System errors
FATAL	Fatal system problem that is causing a process to terminate

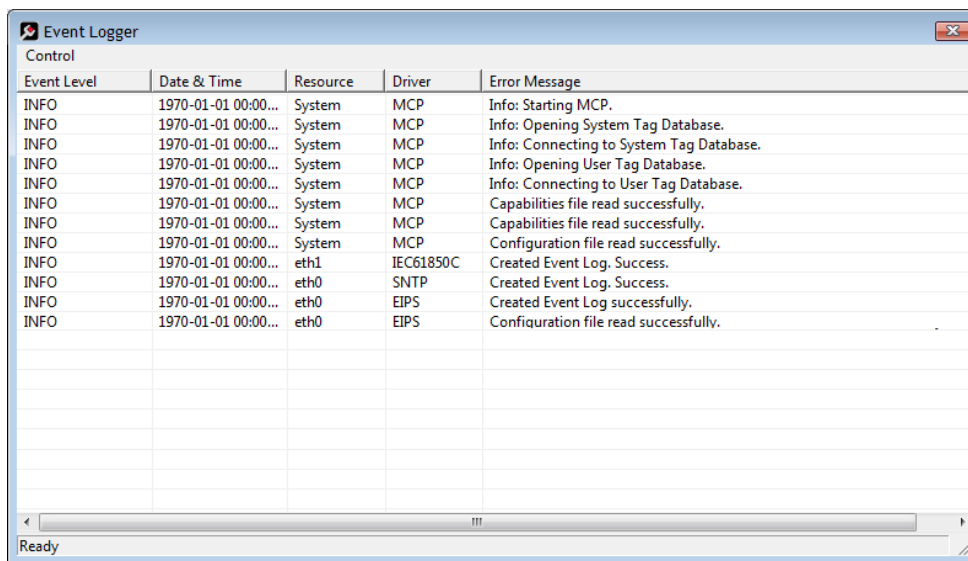

4.8.1 61850C Events

The following are examples that may appear in the Event Log.

```
"61850C_CREATE_EVENTLOG_INFO", "Created Event Log.";
"61850C_CREATE_EVENTLOG_FATAL", "Failed Create Event Log.";
"61850C_LOADING_DATABASE_FATAL", "Error Loading Database.";
"61850C_LOADING_SYSDATABASE_FATAL", "Error Loading System Database.";
"61850C_GET_VAR_TYPE_ID_FATAL", "Error getting initial var type id.";
"IEC61850C_ERROR_CONNECTING_MCPINTERFACE_FATAL", "Cannot Connect to MCP Interface.";
"IEC61850C_CONTROL_NOT_SUPPORTED_INFO", "Control Method Not Supported.";
"IEC61850C_CNXXN_DIDNT_START_INFO", "End Node Connection did not start.";
"IEC61850C_NEED_ONE_VAR_MAPPED_INFO", "Need at least one 61850 Var mapped.";
"IEC61850C_ERROR_STARTING_MVL_ACSE_FATAL", "Error Starting MVL_ACSE Subsystem.";
"IEC61850C_ERROR_FINDING_REPORT_TYPEIDS_FATAL", "Error Finding Report Type ID's.";
"61850C_CMD_TAG_PTR_IS_NULL_FATAL", "Error getting Tag Pointer for command.";
"61850C_RPT_TAG_PTR_IS_NULL_FATAL", "Error getting Tag Pointer for report.";
"61850C_GSE_TAG_PTR_IS_NULL_FATAL", "Error getting Tag Pointer for goose subscription.";
"IEC61850C_RPT_INTEGRITY_PERIOD_SET_DEFAULT_INFO", "Report Integrity Period Set to Default.";
"IEC61850C_ISCAN_DELAY_SET_DEFAULT_INFO", "Interscan Delay Period (2ms) Set to Default.";
"IEC61850C_RPT_CONFREV_TYPE_NOT_VALID_INFO", "Report Config Rev Type not Valid.";
"IEC61850C_RPT_CONFREV_READ_ERROR_INFO", "Report Config Rev Read Error.";
"IEC61850C_RPT_CONFREV_DOESNT_MATCH_CFG_INFO", "Rpt confRev doesn't match, Rpt Not Started.";
"IEC61850C_RPT_CONFREV_RECONNECT_NO_MATCH_CFG_INFO", "Rpt confRev doesn't match, Rpt Not Reconnected.";
"IEC61850C_GSE_DATA_TYPE_ERROR_INFO", "GOOSE Data Type NULL Error.";
"IEC61850C_GCB_CONFREV_TYPE_NOT_VALID_INFO", "GCB Config Rev Type not Valid.";
"IEC61850C_GCB_CONFREV_READ_ERROR_INFO", "GCB Config Rev Read Error.";
"IEC61850C_GCB_CONFREV_DOESNT_MATCH_CFG_INFO", "GCB confRev doesn't match, Subscribe Not Started.";
```

4.8.2 EIPS Events

```
"EIPS_CREATE_EVENTLOG_INFO", "Created Event Log successfully.";
"EIPS_SERVER_CONFIGURATION_FILE_PARSED_INFO", "Configuration file read successfully.";
"EIPS_CONFIG_NO_IMP_ERROR", "Warning: No Implicit Connection defined.";
"EIPS_CONFIG_NO_EXP_ERROR", "Warning: No Explicit Connection defined.";
"EIPS_CONFIG_GET_TAG_ERROR", "Get Tag error: Error code {0}, Error position {1}.";
"EIPS_GET_TAG_PTR_ERROR", "Get Tag Pointer error: {0}.";
"EIPS_GET_IMP_TAG_PTR_ERROR", "Get Implicit Tag Pointer error: {0}.";
"EIPS_GET_EXP_TAG_PTR_ERROR", "Get Explicit Tag Pointer error: {0}.";
"EIPS_DRIVER_ERROR", "EIPS Driver Error: {0}.";
"EIPS_DRIVER_LOAD_ERROR", "Error Loading EIPS Driver.";
"EIPS_INIT_DRIVER_FATAL", "Error Initializing EthernetIP Driver.";
"EIPS_CREATE_EVENTLOG_FATAL", "Error Creating Event Log.";
"EIPS_LOADING_DATABASE_FATAL", "Error Loading EIPS Database.";
"EIPS_ERROR_CONNECTING_MCPINTERFACE_FATAL", "Error Connecting to MCP Interface.";
"EIPS_CREATE_TAG_INTF_SERVER_FATAL", "Error Create Tag Interface Server: {0}.";
"EIPS_CREATE_TAG_INTF_THREAD_FATAL", "Error Create Tag Interface Thread.";
```

4.8.3 MCP Events

The following are examples that may appear in the Event Log.

```
"MCP_START_INFO", "Info: Starting MCP.";  
"MCP_CAPABILITIES_FILE_PARSED_INFO", "Capabilities file read successfully.";  
"MCP_CONFIGURATION_FILE_PARSED_INFO", "Configuration file read successfully.";  
"MCP_DRIVER_STOPPED_UNEXPECTEDLY_ERROR", "Driver stopped unexpectedly, Resource: {1}  
Driver: {2}.";  
"MCP_CAPABILITIES_FILE_NOT_FOUND_FATAL", "Capabilities file not found.";  
"MCP_CAPABILITIES_FILE_EMPTY_FATAL", "Capabilities file empty.";  
"MCP_CAPABILITIES_BAD_FORMAT_FATAL", "Bad Capabilities file format. Missing: {1}.";  
"MCP_CONFIG_FILE_NOT_FOUND_FATAL", "Configuration file not found.";  
"MCP_CONFIG_FILE_EMPTY_FATAL", "Configuration file empty.";  
"MCP_CONFIG_BAD_FORMAT_FATAL", "Bad Configuration file format. Missing: {1}.";  
"MCP_TERMINATING_FATAL", "Fatal error found! Terminating MCP in {1} seconds.";  
"MCP_START_DEBUG", "Debug: Starting MCP.";  
"MCP_START_WARNING", "Warning: Starting MCP.";  
"MCP_START_ERROR", "Error: Starting MCP.";  
"MCP_START_FATAL", "Fatal: Starting MCP.";  
"MCP_CREATE_THREAD_FATAL", "Error creating thread. Return code from pthread_create() = {1}.";  
"MCP_FILE_ERROR", "Error opening file.";  
"MCP_TAGDB_FAIL_FATAL", "Failure opening Tag Database.";  
"MCP_SYSDB_FAIL_FATAL", "Failure opening System Database.";  
"MCP_OPEN_TAGDB_INFO", "Info: Opening Tag Database.";  
"MCP_OPEN_SYSDB_INFO", "Info: Opening System Tag Database.";  
"MCP_CONNECT_SYSDB_INFO", "Info: Connecting to System Tag Database.";  
"MCP_LOADING_DATABASE_FATAL", "Failure connecting to Tag Database.";  
"MCP_UNSCHEDULED_TERMINATION_INFO", "Driver termination.";  
"MCP_DRIVER_KILL_INFO", "Info: Issuing kill signal to driver.";  
"MCP_SYSTEM_TAG_INIT_FAILURE_FATAL", "Failure initializing system tags.";  
"MCP_SYSTEM_OPERATIONS_STOPPED_FATAL", "MCP Stopped operations.";
```

4.8.4 MCP Interface Events

The following are examples that may appear in the Event Log.

```
"MCP_INTERFACE_INIT_FAILED_FATAL", "Initialization failed.";  
"MCP_INTERFACE_LOADING_DATABASE_FATAL", "Error Loading Database.";  
"MCP_INTERFACE_GET_TAG_ERROR", "Get Tag error: Error code {0}, Error position {1}.";
```

4.8.5 SNTP/NTP Events

The following are examples that may appear in the Event Log.

```
"SNTP_CREATE_EVENTLOG_INFO", "Created Event Log.";  
"SNTP_CREATE_EVENTLOG_FATAL", "Failed Create Event Log.";  
"SNTP_LOADING_DATABASE_FATAL", "Error Loading Database.";  
"SNTP_ERROR_CONNECTING_MCPINTERFACE_FATAL", "Cannot Connect to MCP Interface.";  
"SNTP_UPDATE_TIME_FROM_SNTPSERVER_INFO", "Updated Time from SNTP Server.";
```

4.8.6 InterProcess Communication (IPC) Events

The following are examples that may appear in the Event Log.

```
"IPC_ACCEPTED_SOCKET", "Accepted new connection from Client %s on socket %d.";  
"IPC_BAD_MESSAGE_HEADER", "Start of IPC message header was not equal to {0}. Socket will be  
closed.";  
"IPC_CONNECTION_SUCCESSFUL", "Successfully connected to {0}.";  
"IPC_ERROR_BINDING_SOCKET", "Error binding network socket. Port number = {0}.";  
"IPC_ERROR_CLOSING_SOCKET", "Error closing network socket.";  
"IPC_ERROR_CONNECTING_TO_SOCKET", "Error connecting to network socket at {0} port {1}.";  
"IPC_ERROR_CREATING_SOCKET", "Error creating network socket.";  
"IPC_ERROR_GETTING_SOCKET_NAME", "Error getting socket name.";  
"IPC_ERROR_READING_MESSAGE_FORMAT", "Error reading message format from IPC message  
header. Expected to read {0} bytes, but only read {1} bytes.";  
"IPC_ERROR_READING_MESSAGE_LENGTH", "Error reading message length from IPC message  
header. Expected to read {0} bytes, but only read {1} bytes.";  
"IPC_ERROR_SENDING_DATA", "Error sending data to remote system.";  
"IPC_ERROR_SENDING_MESSAGE", "Error sending message to remote system.";  
"IPC_ERROR_SETTING_SOCKET_OPTION", "Error setting socket option.";  
"IPC_INVALID_MESSAGE_FORMAT", "Invalid message format found in IPC message header. Invalid  
message format value = {0}.";  
"IPC_LISTEN_ERROR", "Error listening on network socket.";  
"IPC_MESSAGE_LENGTH_MISMATCH", "Error reading IPC message. Message length did not match  
number of bytes read. Message length = {0}. Number bytes read = {1}.";  
"IPC_RECEIVE_BUFFER_TOO_SMALL", "Unable to receive IPC message because message length is  
larger than receive buffer. IPC message length = {0}. Receive buffer size = {1}.";  
"IPC_REMOTE_CLIENT_DISCONNECTED", "Closing socket because remote Client disconnected.";  
"IPC_SOCKET_ACCEPT_ERROR", "Error accepting new network socket connection.";  
"IPC_SOCKET_ERROR", "Socket error occurred. Closing socket.";  
"IPC_SOCKET_SELECT_ERROR", "Error returned from socket select().";
```

5 Reference

5.1 Specifications

5.1.1 Module

The PLX82-EIP-61850 is has an extruded aluminum case with DIN-rail-mounting.

Specification	Description
Hardware	<ul style="list-style-type: none"> One (1) or two (2) Ethernet port for EtherNet/IP and IEC 61850 communication
Software	<ul style="list-style-type: none"> ProSoft EIP-61850 Configuration Manager for configuration and diagnostic viewing ProSoft EIP-61850 Tag Monitor for viewing live tag data ProSoft Discovery Service for setting a temporary IP address
Configuration Storage	<ul style="list-style-type: none"> Internally stored, by default. Configuration settings can be saved on an optional removable 1GB Industrial SD Card. ProSoft EIP-61850 Configuration Manager saves configuration information to an offline file.

5.1.2 EtherNet/IP (EIP)

The EIP server is an ODVA-certified EtherNet/IP implementation.

Specification	Description
Number of Class 3 server connections	5
Supported PLC types	PLC2, PLC5, SLC, CLX, CMLPX
Class 3 Client connections	Connected - 2 Unconnected - 1
Number of Class 1 I/O connections	20
I/O connection sizes	248/248
Max RPI time	2 ms (1 connection) 8 ms (8 connections)
CIP services supported	0x4C - CIP Data Table Read 0x4D - CIP Data Table Write
Command List	Support for 100 commands per client, each configurable for command type, IP address, register to/from addressing, and word/bit count.
Command Sets	PLC-2/PLC-3/PLC5 Basic Command Set PLC-5 Binary Command Set SLC 500 Command Set

5.1.3 IEC 61850 Client

- Supports up to 20 IEDs
- Send commands from the PAC to the IED using Control Types
- Direct-with-Normal-Security
- Select Before Operate (SBO)-with-Normal-Security
- Direct-with-Normal-Security
- Select Before Operate (SBO)-with-Normal-Security

ASCI Basic Conformance	
SCSMs supported	SCSM: IEC 61850 8.1(MMS) used
Generic substation event model (GSE)	Subscriber
ASCI Model Conformance	
Reporting	<ul style="list-style-type: none"> ▪ Buffered Report Control Block (BRCB) ▪ Unbuffered Report Control Block (URCB)
GOOSE	<ul style="list-style-type: none"> ▪ entryID, DataRefInc
Control	<ul style="list-style-type: none"> ▪ Direct-with-Normal-Security ▪ SBO-with-Normal-Security ▪ Direct-with-Enhanced-Security ▪ SBO-with-Enhanced-Security
Logical Nodes	<ul style="list-style-type: none"> ▪ IEC 61850 Logical Nodes, including Logical Nodes for Hydro Power Plants and Logical Nodes for Wind Power Plants
Configurable Parameters	<ul style="list-style-type: none"> ▪ MMS Command Delay
Status Data	<ul style="list-style-type: none"> ▪ Status available per node ▪ Report and GOOSE status available

5.1.4 SNTP/NTP Client

The gateway supports a Simple Network Time Protocol (SNTP/NTP) client service that can synchronize the gateway's time by periodic update requests to a Coordinated Universal Time (UTC) system. You can configure the SNTP/NTP server details in ProSoft EIP-61850 Configuration Manager. The resolution of the time is in milliseconds (ms).

Configurable Parameters	<ul style="list-style-type: none"> ▪ SNTP/NTP server synchronization rate (in minutes) ▪ SNTP/NTP server Address
-------------------------	--

5.2 Hardware Specifications

Specification	Description
Power Supply	24 VDC nominal 10 to 32 VDC power input allowed Positive, Negative, GND Terminals
Current Load	200 mA maximum @ 24 VDC 150 mA maximum @ 32 VDC 450 mA maximum @ 10 VDC
Operating Temperature	0°C to 70°C (32°F to 158°F)
Storage Temperature	-40°F to 185°F (-40°C to 85°C)
Relative Humidity	5% to 95% RH, with no condensation
Dimensions H x W x D	5.52 x 2.06 x 4.37 in 14.02 x 5.23 x 11.1 cm
Ethernet Ports ETH 1, ETH 2	10/100 Base-T full- and half-duplex RJ45 Connector Link and Activity LED indicators Electrical Isolation 1500 V rms at 50 Hz to 60 Hz for 60 s, applied as specified in section 5.3.2 of IEC 60950: 1991 Ethernet Broadcast Storm Resiliency = less than or equal to 5000 [ARP] frames-per-second and less than or equal to 5 minutes duration
LED Indicators	ERR, CFG, FLT, PWR
Shock and Vibration	Shock and Vibration tested to EN 60068 Standard
Shipped with Each Unit	One - J180 3-wire DC power connector One - HRD250 screwdriver

5.3 LEDs

5.3.1 Module LEDs

LED	State	Description
Pwr	OFF	Power is not connected to the power terminals or source is insufficient to properly power the gateway (800mA at 24 VDC minimum required)
	Solid GREEN	Power is connected to the power terminals. Verify that the other LEDs for operational and functional status come on briefly after power-up (check for burned-out LEDs).
Flt	OFF	Normal operation
	Solid RED	A critical error has occurred. Program executable has failed or has been user-terminated and is no longer running. Press Reset p/b or cycle power to clear error.
Cfg	OFF	Normal operation
	Solid AMBER	The unit is in configuration mode. The configuration file is currently being downloaded or, after power-up, is being read, the unit is implementing the configuration values, and initializing the hardware. This occurs during power cycle, or after pressing the reset button. It also occurs after a cold/warm boot command is received.
Err	OFF	Normal operation
	Flashing	An error condition has been detected and is occurring on one of the application ports. Check configuration and troubleshoot for communication errors.
	Solid AMBER	This error flag is cleared at the start of each command attempt (client) or on each receipt of data (server); so, if this condition exists, it indicates a large number of errors are occurring in the application (due to bad configuration) or on one or more ports (network communication failures).

5.3.2 Ethernet Port LEDs

LED	State	Description
Data	OFF	No activity on the Ethernet port.
	Flashing GREEN	The Ethernet port is actively transmitting or receiving data.
Link	OFF	No physical network connection is detected. No Ethernet communication is possible. Check wiring and cables.
	Solid GREEN	Physical network connection detected. This LED must be on solid for Ethernet communication to be possible.

5.4 Gateway Specifications

The PLX82-EIP-61850 gateway provides bi-directional transfers between EtherNet/IP controllers and IEC 61850 devices. The EtherNet/IP driver supports I/O connections for guaranteed data delivery or message instructions to send data to/from the PPACs. The platform design is based on the ARM 0 technology.

5.4.1 Asynchronous Processes

The gateway has a number of processes and drivers running in it in a multitasking firmware environment. An IEC 61850 client driver and an EtherNet/IP driver operate asynchronously within this multitasking environment, along with other firmware processes. The drivers are independently processing the commands and messages in their queues as quickly as possible, giving priority to GOOSE messages.

The EtherNet/IP driver processes data exchanges on the connections that have been enabled at the configured RPI.

Meanwhile, the IEC 61850 client may be receiving large amounts of data from the configured IEDs. If so, the IEC 61850 client updates the Tag database with data coming from the IEDs asynchronously from what's happening with the EIP driver.

Since the different drivers run asynchronously from each other and depending upon how fast or how often IEDs send data, it is possible that a tag in the Tag database may be updated more than one time by the IEC 61850 client driver before the EtherNet/IP driver sees the update and can send the data to a PLC.

IED data changes are not buffered, so the EtherNet/IP driver may not be able to transfer every data change that happens in the IEC 61850 client Tag database. Only the data most recently stored in the Tag database by the IEC 61850 client driver is available for the EIP driver to transfer to EtherNet/IP device. So, it is possible that some changes in data values on some IEDs may be lost in the process, especially during times of high volume IED data traffic.

5.4.2 Tag Database

The Tag database is a key part of the internal workings of the gateway. Upon restart, the Tag database reads the configuration file, and process the tags. Data is stored in the gateway’s memory, and referenced through tag names. The number of tags is limited to the memory capability of the hardware and the process memory required by gateway. The data of varying data types are stored in the gateway. This impacts that maximum number of tags the gateway can hold.

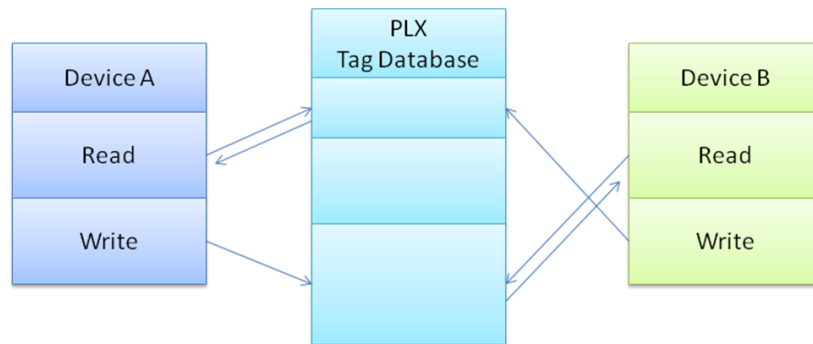

Some data types are considered **Native** data types to the gateway, and some are considered **Complex**. Complex data types are for the creation of the user-defined data types, which are necessary for many IEC 61850 data types.

Native data types

Native data types are the data types used internal to the gateway. When the data is transferred from IEC 61850 to EtherNet/IP, it is first stored in the Tag database, using the following data types:

Name	Definition	Bits
BOOL	Boolean	1
BYTE	Byte	8
UBYTE	Unsigned Byte	8
INT	Integer	16
UINT	Unsigned Integer	16
DINT	Double Integer	32
UDINT	Unsigned Double Integer	32
REAL	IEEE 754 Single Precision Floating-Point	32
DREAL	IEEE 754 Double Precision Floating-Point	64
STRING	ASCII Character Array	32 + 8* Length
DATETIME	UTC microsecond precision date and time	64

5.4.3 SNTP/NTP

This section covers the gateway's implementation of IEC 61850-7-2 Clause 18: Time and time-synchronization model (SNTP/NTP).

The IEC 61850 driver in the gateway is dependent upon the gateway's SNTP/NTP server. The gateway can set its time by making periodic requests for the current time to a Coordinated Universal Time (UTC) system. You can define a NTP server in ProSoft EIP-61850 Configuration Manager. It must be synchronized to some known level of accuracy, and the elapsed seconds received by the NTP server are since a defined Epoch, and the time server shall indicate LeapSecondsKnown (true or false).

There are two configuration parameters:

- SNTP/NTP server Address
- SNTP/NTP server Update Time (in minutes)

ProSoft Gateway Configuration

Select Module:

PLX81

PLX82 - 2 Ports

PLX82 - 1 Port

Project Name: Project 1

Notes:

Ethernet Port E1

IEC 61850

Ethernet/IP

IP Address: 192 . 168 . 0 . 250

Subnet Mask: 255 . 255 . 255 . 0

Default Gateway: 192 . 168 . 0 . 1

NTP Address: 128 . 138 . 140 . 44

NTP Update Time: 1

Ethernet Port E2

IEC 61850

Ethernet/IP

IP Address: 192 . 168 . 1 . 250

Subnet Mask: 255 . 255 . 255 . 0

Default Gateway: 192 . 168 . 1 . 1

OK Cancel

The gateway hardware is 17 seconds off per day for a Linux clock. If better time synchronization is required, you must perform the setup for the SNTP/NTP time server either from the internet or local clock that can sync up every one (1) minute as configured on the gateway.

5.5 IEC 61850 Specifications

The IEC 61850 client driver supports the MMS (ISO 9506-1 and ISO 9506-2) communication profile.

Part 7-2 of the IEC 61850 protocol specification lists the basic communication structure and abstract communication service interface (ACSI). This IEC 61850 client driver supports the following 7-2 models:

- Association
- Data Set
- Report Control Block (data is updated based upon various trigger options)
- GOOSE (Generic Object Oriented Substation Event, data is updated based upon data change only)
- Control
- Time and time-synchronization
- Naming conventions

Part 8.1: MMS later in this document lists the data types supported by IEC 61850. This is important for understanding how data mapping in the gateway works. Other protocols do not all support the many data types that IEC 61850 does, so the IEC 61850 data is converted to an appropriate data type in the other protocol.

5.5.1 Application Association Model

This section describes the gateway's implementation of IEC 61850-72- Clause 7: Application association model. This clause describes how the association between two devices is achieved:

- Two-Party-Application-Association
and/or
- Multicast-Application-Association

Both types are used.

Two Party Messaging

Two Party messaging is the most common type of messaging our IEC 61850 driver performs. The following diagrams show the execution of two-party messages, and their associated abort sequence. In the diagrams, the IEC 61850 client driver is the client. This information and diagrams have been taken directly from the IEC 61850 standard.

The services for associate, data exchange, and association release of the two-party application association class is depicted in Figure 7.

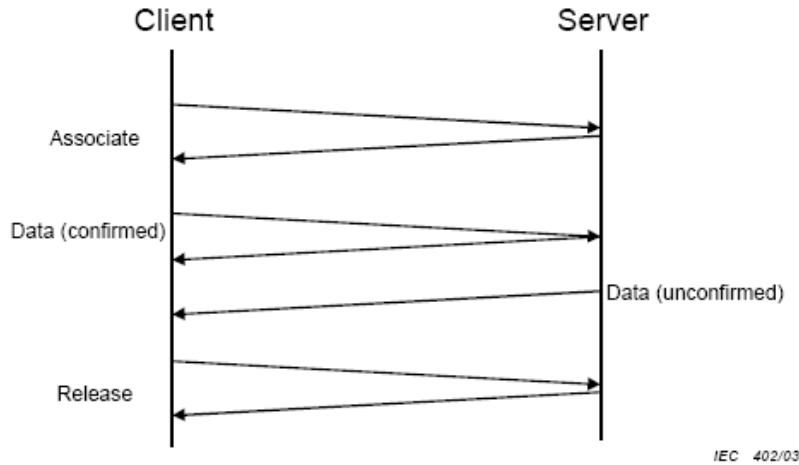

Figure 7 – Normal operation

The abort service for the two-party application association class is depicted in Figure 8.

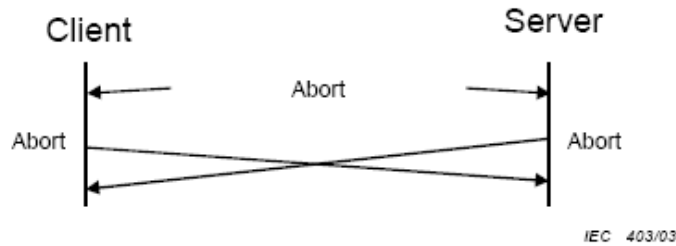

Figure 8 – Aborting association

Two party messages use these services: Associate, Abort, and Release.

For **TWO-PARTY-APPLICATION-ASSOCIATION** the following services are defined.

Service	Description
Associate	Establish an association
Abort	Abort an association
Release	Release an association

Multicast

Multicast information exchange is performed between a source (publisher) and one or more destinations (subscribers). For the IEC 61850 protocol, this is known as GOOSE and GSSE messages. See the ACSI Service Conformance Statement later in this document, with the AA (Application Association) column marked with MC (Multicast). This diagram has been taken directly from the IEC 61850 Standards document.

The subscriber shall be capable to detect loss and duplication of information received. The receiver shall notify the loss of information to its user and shall discard duplicated information.

NOTE The possible restriction of multicast messages to be exchanged on a single subnet or sent through routers is an issue to be defined in an SCSM.

The multicast application association class is depicted in Figure 9.

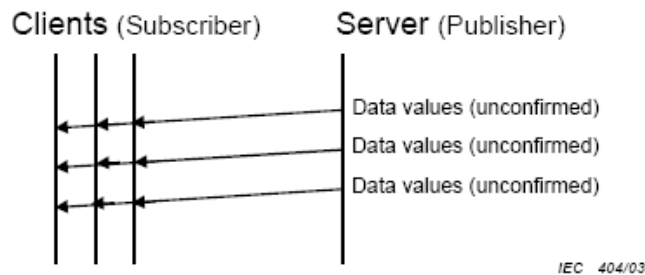

Figure 9 – Principle of multicast application association

5.5.2 DATA-SET

The DATA-SETs are important for Buffered Report Control Blocks (BRCBs), Unbuffered Report Control Blocks (URCBs), and GOOSE Control Blocks. These Report Control Blocks (RCBs) reference a DATA-SET to know what data to send to the IEC 61850 client. For some IEDs, the DATA-SET may be:

- Static
- Dynamic
- Optionally not reported in its entirety

This variability is based on features of specific IEDs. The ProSoft EIP-61850 Configuration Manager does not allow you to dynamically create a DATA-SET on the IED.

The definition of a DATA-SET is the group of Data Attributes that make up the DATA-SET. DATA-SETs (if they exist) are defined as part of the IED's configuration, as provided by the IED manufacturer.

The assignment of the DATA-SET to a BRCB, URCB, or GOOSE Control Block is set on the IED. These DATA-SET definitions are currently outside the scope of the gateway. See the BRCB, URCB, and GOOSE sections of this document to understand how DATA-SETs are used by the gateway, and for examples. This table has been taken directly from the IEC 61850 Standards document.

For **DATA-SET** the following services are defined.

Service	Description
GetDataSetValues	Retrieve all values of DATA referenced by the members of the DATA-SET
SetDataSetValues	Write all values of DATA referenced by the members of the DATA-SET
CreateDataSet	Create a DATA-SET by providing the FCD (FCDA) references or that form the DATA-SET
DeleteDataSet	Delete a DATA-SET
GetDataSetDirectory	Retrieve FCD references of all members referenced in the DATA-SET

5.5.3 Report Control Block

This section describes the gateway's implementation of IEC 61850-7-2 Clause 14: REPORT-CONTROL-BLOCK.

Log and logging is not supported at this time.

The Report Control Block (RCB) is made available to you through the ProSoft EIP-61850 Configuration Manager. The parsing of the CID/SCD file discovers the ReportControl element, which is unique within the Logical Node (LN). The ProSoft EIP-61850 Configuration Manager presents the ReportControl items to you, for you to map to the other protocol in the gateway if required or desired. There are two types of Report Control Blocks (RCBs):

- Buffered Report Control Blocks (BRCB)
- Unbuffered Report Control Blocks (URCB)

Supported Report Control Block Features

- RptEnabled
- TrgOps

When the gateway is configured to use an IED's report, after the gateway establishes a connection with the IED, it turns on **RptEnabled**. The gateway then receives the reports it's configured to receive.

TrgOps tells the gateway which internal event produces the inclusion of a DATA-SET member onto a report. TrgOps options are:

- Data change (dchg)
- Quality change (qchg)
- Data update (dupd)
- General Interrogation

The reason for inclusion of a piece of data in the report is because the IED is dependent upon the TrgOps (Trigger Options) in the CID/SCD file.

Report Control Block Services

There are three typical RCB services:

- Report
- GetBRCBValues
- SetBRCBValues

The process starts with the client issuing a **RptEna** (report enable), as follows. This diagram has been taken directly from the IEC 61850 Standard document.

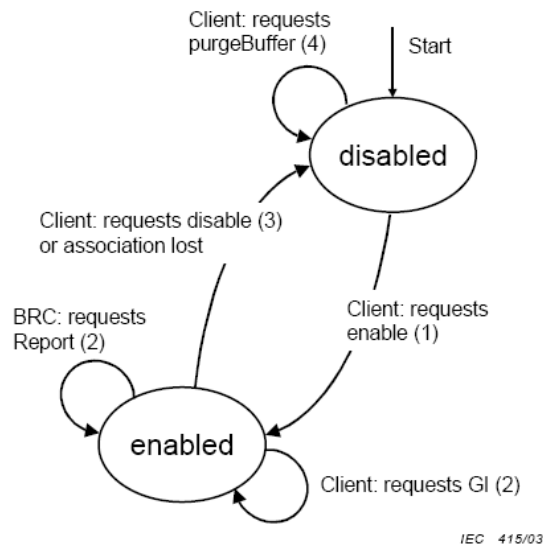

Figure 20 – BRCB state machine

The Report service is used by the BRCB to send reports from the server to the client. Transmission is unconfirmed, meaning there is no validation check at the client or acknowledgement from the client back to the server. This table has been taken directly from the IEC 61850 Standard document.

Table 24 – Report format specification

ReportFormat		
Parameter name	Parameter type	Explanation
RptID	VISIBLE STRING65 ^a	Report identification
OptFlds	^a	Optional fields to be included in the report
IF sequence-number = TRUE in optFlds		
SqNum	INT16U	Sequence number
SubSqNum	INT16U	Subsequence number
MoreSegmentsFollow	BOOLEAN	More report segments with the same sequence number follow
IF dat-set-name = TRUE in optFlds		
DatSet	ObjectReference ^a	Data set reference
IF buffer-overflow = TRUE in optFlds		
BufOvfl	BOOLEAN	TRUE shall indicate that a buffer overflow has occurred.
IF conf-revision = TRUE in optFlds		
ConfRev	INT32U	
Entry		
IF report-time-stamp = TRUE in optFlds		
TimeOfEntry ^b	EntryTime	
IF entryID = TRUE in optFlds		
EntryID ^b	EntryID	
EntryData [1..n]		
IF data-reference = TRUE in optFlds		
DataRef	ObjectReference	Respective DataAttrRef
Value	(*)	(*) type(s) depend on the definition of common data classes in IEC 61850-7-3
ReasonCode	TriggerConditions	If reason-for-inclusion (= TRUE) in optFlds
^a The type and value of this parameter shall be derived from the respective attribute of the BRCB .		
^b TimeOfEntry and EntryID shall be available only if both report-time-stamp = TRUE AND entryID = TRUE in optFlds.		

RptID is derived.

The entire contents of Table 24 is not created as tags and therefore not brought over to the other protocol. Only the Tag Names (mapped Data Attributes) are available to the other protocol. Although the IED buffers data changes, only the most recent data values sent by the IED are processed by the gateway.

Buffered Report Control Block

The BRCB report controls are used by a client implementing a well-defined functionality, for example, a SCADA master. If the IEC 61850 client cannot access the report, it's probably due to access control. When one BRCB for the IED is in use, no other clients may access it.

The configuration file gives the IEC 61850 client driver the following:

- Domain Name
- Data Path
- Report ID
- Enable Flag
- Intpd
- Confrev
- Trgopdchg
- Tag Names

The Tag Names are a list of the Data Attributes as defined by the DATA-SET for the report. The ProSoft EIP-61850 Configuration Manager parses through the DATA-SET definition to determine the lowest level of the Data Attributes contained in it and creates those tags in the configuration file with the proper data type. You can choose which elements of the DATA-SET are mapped to EtherNet/IP.

For those DATA-SET Data Attributes that are not mapped, the ProSoft EIP-61850 Configuration Manager creates dummy tags as place holders for those Data Attributes. The dummy tags take up space in the tag database, even if they are not mapped to the EtherNet/IP driver.

The IEC 61850 driver processes report data from the IED by offsets, not by actual Data Attribute name. If the DATA-SET on the IED changes, you must re-import the CID/SCD file into the ProSoft EIP-61850 Configuration Manager to reconfigure the gateway, so that the gateway's internal processing of the report is done correctly.

If the BRCB is mapped in the gateway's configuration, then the IEC 61850 driver automatically turns on the Report Enable (RptEna) for the IED's BRCB.

Unbuffered Report Control Block

URCB data is sent immediately to the connected IEC 61850 client. If the transport data flow is not fast enough to support the movement of this data, some may be lost. The IED can have multiple instances of the URCB data, and in this case, the IED server manages the separation of the instances transmitted to the IEC 61850 clients.

- If a URCB is mapped in the gateway's configuration, then the IEC 61850 driver automatically turns on the Report Enable (RptEna) for the IED's URCB.
- The unbuffered reports is sent automatically from the IED to the gateway while Report Enable is on.
- The IEC 61850 driver and configuration software implements URBCs the same as BRCBs.

Unsupported Report Control Block Features

OptFlds are the optional fields that the IED can include in the report:

- Sequence number
- Report time stamp
- Reason for inclusion
- Data set name
- Data reference
- Buffer overflow
- entryID

The gateway only updates the value of the tags (**Data Attributes**) in the tag database. The optional fields from the reports are not stored in the tag database, and unsupported.

5.5.4 GOOSE Control Block

Below is the GOOSE control block class definition. This table has been taken directly from the IEC 61850 Standard document.

GOOSE control block class definition

GoCB class				
Attribute name	Attribute type	FC	TrgOp	Value/value range/explanation
GoCBName	ObjectName	GO	-	Instance name of an instance of GoCB
GoCBRef	ObjectReference	GO	-	Path-name of an instance of GoCB
GoEna	BOOLEAN	GO	dchg	Enabled (TRUE) disabled (FALSE)
AppID	VISIBLE STRING65	GO		Attribute that allows a user to assign a system unique identification for the application that is issuing the GOOSE. DEFAULT GoCBRef
DatSet	ObjectReference	GO	dchg	
ConfRev	INT32U	GO	dchg	
NdsCom	BOOLEAN	GO	dchg	
Services				
GetGoReference GetGOOSEElementNumber GetGoCBValues SetGoCBValues				

The only TrgOp (trigger options) is dchg (data change). So GSE data is being passed from the publisher to the subscriber only:

- a) when the IED first enters the network
- b) when the data changes on the publisher

You can set up GOOSE messages in the IEDs for only that data needs to be sent to the gateway. That way, GOOSE messages contains only needed data.

Below is the GOOSE message format. This table has been taken directly from the IEC 61850 Standard document.

Table 29 – GOOSE message definition

GOOSE message		
Parameter name	Parameter type	Value/value range/explanation
DatSet	ObjectReference	Value from the instance of GoCB
AppID	VISIBLE STRING65	Value from the instance of GoCB
GoCBRef	ObjectReference	Value from the instance of GoCB
T	EntryTime	
StNum	INT32U	
SqNum	INT32U	
Test	BOOLEAN	(TRUE) test (FALSE) no-test
ConfRev	INT32U	Value from the instance of GoCB
NdsCom	BOOLEAN	Value from the instance of GoCB
GOOSEData [1..n]		
Value	(*)	(*) type depends on the common data classes defined in IEC 61850-7-3. The parameter shall be derived from GOOSE control

Although this entire GOOSE message is received, the gateway only stores GOOSEData [1..n] in the tag database.

GOOSE Messages

The gateway implements GSE messages according to IEC 61850-7-2 Clause 15.

The IEC 61850 driver acts as a client, subscribing to the messages. The IEDs act as a servers, publishing the messages.

GSE messages can help activate equipment safety interlocks (the IED prevents harming the operator or itself).

GOOSE Priority

The gateway gives GOOSE messages processing priority over other IEC data messages. If a GOOSE message is received, the GOOSE message is processed ahead of all other data transfer (MMS, Reporting) in the gateway at that moment.

GOOSE Subscription Status

The gateway’s GOOSE subscription verifies match of confRev in a manner identical to the verification performed when enabling a report.

If the confRev does not match (unavailable, wrong type, different value), then the GOOSE is not subscribed and an Event is logged in the Event Logger describing the reason.

If the data type of confRev fetched from the IEC device is not **RT_UNSIGNED**, then no event is logged.

The command, **confRev** must match what is running in the IED when the gateway comes on-line with the current configuration, or the gateway does not successfully subscribe to the GOOSE message.

The gateway does not check for a match of the GOOSE AppID from the CID file to the actual running IED when performing a GOOSE subscription.

IED Disconnect/Reconnect

If for any reason an IED disconnects from the network, the gateway continually polls for the device and attempt to reconnect.

5.5.5 Control

Operate

Used by Direct control with normal security, SBO control with normal security, Direct control with enhanced security, and SBO control with enhanced security to write data to IED devices.

In the case where the logical node has (for example) **Pos** data that has **SBOw**, **Oper**, and **Cancel**, you need to map the **Oper** structure only when wanting to control that data. SBOw, Oper, and Cancel all refer to controlling the same Data Attributes on the IED. The gateway automatically handles the select with value. So although the SBOw and Cancel can be seen in the configuration software, they should not be mapped. Only the Oper should be mapped. The Cancel structure should only be mapped if it is required.

The IEC 61850 Oper Structure has Data Attributes as defined by the standard. When you make MMS Writes from the Ethernet/IP device to the IED, if you do not populate all data elements of Oper, the gateway by default populates the other data elements with 0 (zero). The exception to this is **T** which is always set to the current time in the gateway.

The IEC 61850 client driver needs to provide the following information to the IED. These Data Attributes are available for you to select and set. This table has been taken directly from the IEC 61850 Standard document.

The **Operate** service shall define the following service parameters.

Parameter name
Request
ControlObjectReference
Value
T
Test
Check
Response+
ControlObjectReference
Value
T
Test
Response-
ControlObjectReference
Value
T
Test
AddCause

ctlVal

This must be set for:

- SPC (Single Point Control)
- DPC (Double Point Control)
- INC (Controllable Integer Status)
- BSC (Binary Controlled Step Position Information)
- ISC (Integer Controlled Step Position Information)
- CDCs (Common Data Classes)

This next section has been taken directly from the IEC 61850 Standard document.

17.5.2.2 Value

The parameter **Value** shall include values for all implemented **DataAttributes** of a controllable common **DATA** class that are accessed by various control services.

NOTE Common **DATA** classes and their **DataAttributes** are defined in IEC 61850-7-3.

EXAMPLE For the case of an **Operate** request, the value may include the following parameters:

- control value (on, off),
- originator category (remote, station, bay...),
- control sequence number.

setMag

- You must set this for APC (Controllable Analogue Set Point Information) CDC.

operTm

- The PLC user sends a command with operate time to the gateway, and the gateway uses time activated control, e.g. it sends the time of operation to the IED. The IED needs to support the time activated control.

origin.orCat

- The **orCat** could have these values. The value depends upon the role of the PLC. E.g. if the PLC is a station control, then this value never changes.

Parameter	Description
not-supported	orCat is not supported.
bay-control	Control operation issued from an operator using a client located at bay level.
station-control	Control operation issued from an operator using a client located at station level.
remote-control	Control operation from a remote operator outside the substation (for example network control center).
automatic-bay	Control operation issued from an automatic function at bay level.
automatic-station	Control operation issued from an automatic function at station level.
automatic-remote	Control operation issued from an automatic function outside of the substation.
maintenance	Control operation issued from a maintenance/service tool.
process	Status change occurred without control action (for example external trip of a circuit breaker or failure inside the breaker).

origin.orldent

- This is the address of the originator. The value you want depends upon the role of the PLC.

ctlNum

- This is of no consequence to the IED and only appears in reports. This is an optional parameter. The ctlNum may be of interest to you when the client uses the same control number for a complete control sequence: select, operate, ...

T

- This is the time the IEC 61850 client sent the control request. The IEC 61850 client driver writes this value using the current gateway time. This table has been taken directly from the IEC 61850 Standard document.

17.5.2.3 T – control time-stamp

The parameter **T** shall be the time when the client sends the control request.

Table 36 – Control time-stamp definition

Control time-stamp type		
Attribute name	Attribute type	Value/value range/explanation
T	EntryTime	

Test

- Test issues are still early in IEC 61850 use. This is only required if the customer really wants to issue a control command which should be interpreted by the IED as a command that should not cause a real operation.

Check

- Your specific application determines if or how this parameter is used. This parameter determines whether control actions are done immediately without interlock or synchrocheck, or if an interlock or synchrocheck is performed before the operation is done. Some other part of your application may do these checks anyway, even if checks are not used here. You can set the PLC to always use or always not use checks, or it can enable or disable checks for each control action when the control message is sent. This table has been taken directly from the IEC 61850 Standard document.

17.5.2.5 Check – check condition

The parameter **Check** shall specify the kind of checks a control object shall perform before issuing the control operation if common **DATA** class is **DPC** (double-point control – see IEC 61850-7-3).

Table 38 – Check condition definition

Check condition type		
Attribute name	Attribute type	Value/value range/explanation
Check	PACKED LIST	
synchrocheck	BOOLEAN	TRUE means run synchrocheck
interlock-check	BOOLEAN	TRUE means run interlock-check

IEC 61850 MMS Write

This covers the gateway's implementation of IEC 61850-7-2 Clause 17: CONTROL Class model (Writable Data).

The IEC 61850 driver is able to write to some IED Data Attributes. The writable Data Attributes are those that are identified in the ICD file with control classes of:

- Direct with normal security
- Select Before Operate (SBO) with normal security
- Direct with enhanced security
- Select Before Operate (SBO) with enhanced security

Control with normal security is for Data Attributes in which the client does not receive failure information. This implies that there would not need to be any action taken by a supervisory control on the system if the value of the Data Attribute did not change to the value the IEC 61850 driver was trying to write to it. The gateway receives an acknowledgment (**ack**) indicating if it worked or not.

The control function may optionally include a **Select** step, used to check that the control may be valid and to eventually lock a resource. **SBO-with-normal-security** and **SBO-with-enhanced-security** include the Select step. This is handled automatically by the gateway.

IEDs have certain filters in them that check that there is no damage if the control is issued. These functions are listed under "System control functions".

- **Control unity** (on the controlled item, in the bay, in the voltage level, in the substation).
- **Interlock validity**: Interlocking is a parallel function that delivers a status to enable or disable a control (if interlock is set to on). The control message may contain an interlock violation status to bypass it.
- **Synchrocheck validity**: When closing a breaker, the synchrocheck verifies some electrotechnical conditions and enable or disable the control.
- **Time validity**: The control contains a time attribute that specifies the time limit for issuing the control. This avoids issuing an old control that would have been stacked into the network.
- **Locked status**: A controlled item may be under lock status when the substation is partly in maintenance mode. This prohibits any control, for example, on a breaker if an operator is performing some repair on the line. Note that locking an item is an example of control.
- **Control privilege**: This is needed if an operator expects to control an item to check his privileges.
- **Substation and bay mode status**: The substation should be in remote mode to enable remote control (i.e. from SCADA) and in local mode to enable control issued inside the substation. The bay mode should be in remote mode to enable control from the station level or remote control level (SCADA).
- **State of the controlled item**: The control should lead the controlled item into an authorized state (for example, it is impossible to open an open disconnecter). When the controlled item is in an unknown state (for example, double point status have the same value), this filter is optionally suppressed.

Control is canceled if one of these filters is not verified or if a cancel order is received from the control point.

5.5.6 MMS

Part 8-1 of the protocol specification details the Specific Communication Service Mapping (SCSM), which is mapping of data to MMS (ISO 9506-1 and ISO 9506-2). The IEC 61850 driver is fully compliant to the MMS requirement.

In terms of the seven-layer OSI model, the new MMS stack looks like this:

Specification	Description
Application	Association Control Service Element (ACSE)- ISO 8649/8650
Presentation	Connection Oriented Presentation - ISO 8822/8823 Abstract Syntax Notation (ASN)- ISO 8824/8825
Session	Connection Oriented Session - ISO 8326/8327
Transport	ISO transport over TCP - RFC 1006 Transmission Control Protocol (TCP) - RFC 793
Network	Internet Control Message Protocol (ICMP) - RFC 792 Internet Protocol (IP)- Address Resolution Protocol (ARP)- RFC 826
Link	IP datagrams over Ethernet - RFC 894 MAC - ISO 8802-3 [Ethernet]
Physical	Ethernet

Data Types

Understanding the data types used by the PLX82-EIP-61850 is helpful for understanding data transfer for IEC 61850-7-2 Clause 14 (BRCB & URCB), 15 (GOOSE), and 17 (CONTROL). This table has been taken directly from the IEC 61850 Standard document.

Basic data types

The **BasicTypes** shall be as listed in Table 2.

Table 2 – BasicTypes

BasicTypes			
Name	Value range	Remark	Used by
BOOLEAN			IEC 61850-7-3 IEC 61850-7-2
INT8	-128 to 127		IEC 61850-7-3 IEC 61850-7-2
INT16	-32 768 to 32 767		IEC 61850-7-3 IEC 61850-7-2
INT24	-8 388 608 to 8 388 607	for TimeStamp type	IEC 61850-7-2
INT32	-2 147 483 648 to 2 147 483 647		IEC 61850-7-3 IEC 61850-7-2
INT128	-2**127 to (2**127)-1	Required for counters	IEC 61850-7-3
INT8U	Unsigned integer, 0 to 255		IEC 61850-7-3 IEC 61850-7-2
INT16U	Unsigned integer, 0 to 65 535		IEC 61850-7-3 IEC 61850-7-2
INT24U	Unsigned integer, 0 to 16 777 215		IEC 61850-7-2
INT32U	Unsigned integer, 0 to 4 294 967 295		IEC 61850-7-3 IEC 61850-7-2
FLOAT32	Range of values and precision as specified by IEEE 754 single-precision floating point		IEC 61850-7-3
FLOAT64	Range of values and precision as specified by IEEE 754 double-precision floating point		IEC 61850-7-3
ENUMERATED	Ordered set of values, defined where type is used	Custom extensions are allowed	IEC 61850-7-3 IEC 61850-7-2
CODED ENUM	Ordered set of values, defined where type is used	Custom extensions shall not be allowed. Type shall be mapped to an efficient encoding in a SC5M	IEC 61850-7-3 IEC 61850-7-2
OCTET STRING	Max. length shall be defined where type is used ^a		IEC 61850-7-3 IEC 61850-7-2
VISIBLE STRING	Max. length shall be defined where type is used ^a		IEC 61850-7-3 IEC 61850-7-2
UNICODE STRING	Max. length shall be defined where type is used ^a		IEC 61850-7-3

^a The length suffix shall have the format "...STRINGnn" where "nn" is the length in characters.

EntryID

EntryID is 8 octet fixed length MMS OCTET STRING.

PACKED LIST

PACKED LIST is MMS Bit-string of variable length. Bit 0 is the leftmost (most significant) bit of the first octet. Bit 7 is the rightmost (least significant) bit of the first octet. Bit 8 is the leftmost (most significant) bit of the second octet. Bit 15 is the rightmost (least significant) bit of the second octet, etc. Exceptions to this are time and quality. This table has been taken directly from the IEC 61850 Standard document.

Table 15 – Encoding of IEC 61850-7-2 TimeQuality

Bit	Value	Meaning
0		Leap Second Known
1		ClockFailure
2		Clock not synchronized
3-7		Time accuracy of fractions of second
	00000	0 bit of accuracy
	00001	1 bit of accuracy
	00010	2 bits of accuracy
	00011	3 bits of accuracy
	00100 - 11000	Integer value of number of bits of accuracy
	11000- 11110	Invalid
	11111	unspecified

Bit 0 is the most significant bit of octet 7. Bit 7 is the least significant bit of octet 7. The octet format is (using ASN.1 bstring notation).

EntryTime

EntryTime is mapped as BINARY-TIME, and is six octets.

TriggerConditions

TriggerConditions, such as those used in BRCB, are encoded as a PACKED LIST, yet bit 0 is reserved.

- Bit 0 Reserved (reserved to provide backward compatibility with UCA 2.0)
- Bit 1 data-change
- Bit 2 quality-change
- Bit 3 data-update
- Bit 4 integrity
- Bit 5 general-interrogation

Quality

Quality is packed as 13 bits. This table has been taken directly from the IEC 61850 Standard document.

Table 16 – Encoding of IEC 61850-7-3 quality

Bit(s)	IEC 61850-7-3		Bit-String	
	Attribute name	Attribute value	Value	Default
0-1	Validity	Good	0 0	0 0
		Invalid	0 1	
		Reserved	1 0	
		Questionable	1 1	
2	Overflow		TRUE	FALSE
3	OutOfRange		TRUE	FALSE
4	BadReference		TRUE	FALSE
5	Oscillatory		TRUE	FALSE
6	Failure		TRUE	FALSE
7	OldData		TRUE	FALSE
8	Inconsistent		TRUE	FALSE
9	Inaccurate		TRUE	FALSE
10	Source	Process	0	0
		Substituted	1	
11	Test		TRUE	FALSE
12	OperatorBlocked		TRUE	FALSE

Functional Constraints

Each IEC 61850 Data Attribute has a Functional Constraint (FC), which shows what the data is or how it is used. For example, Data Attributes with FC=ST are status data. Data Attributes with FC=CO can be controlled.

You can see the Data Attributes Functional Constraints in the IEC Mapping Tool window, for example:

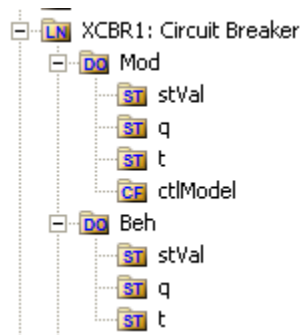

Note: the icons provide information. **DO** is for Data Object. Within the DO, there may be multiple levels of data. When we get down to the Data Attribute level, the functional constraint of the Data Attribute is shown in the icon, e.g. **CO** for Control, **ST** for Status Information, and **CF** for Configuration.

List of IEC 61850 Functional Constraints:

Functional Constraint	Description
ST	Status information
MX	Measurands (analog values)
CO	Control
SP	Setpoint
SV	Substitution
CF	Configuration
DC	Description
SG	Setting Group
SE	Setting group editable
EX	Extended definition
BR	Buffered report
RP	Unbuffered report
LG	Logging
GO	GOOSE Control
MS	Multicast sampled value control
US	Unicast sampled value control
XX	Represents Data Attributes as a service parameter. XX is a wildcard.

5.5.7 EtherNet/IP Adapter

EtherNet/IP Server Startup Sequence:

- 1 Connect to Event Logger.
- 2 Connect to tag database – Error message in event log on fail.
- 3 Initialize configuration file – Error message if cannot create configuration object.
- 4 Connect to system tag database.
- 5 Connect to MCP – Error message in event log on fail.
- 6 Parse configuration file – Message in event log on success.
- 7 Create copy thread to copy data to/from tagDB and Input/Output buffers.
- 8 Run EtherNet/IP driver.
- 9 Inform MCP that driver is ready to run.

Initialize diagnostics: This step is to prevent a race between diagnostic and EtherNet/IP connections.

5.5.8 IEC 61850 Client

IEC 61850 client startup sequence:

- 1 Verify process arguments from MCP.
- 2 Connect to the Event Log; upon success log Event.
- 3 Connect to System tag DB; upon failure log Event.
- 4 Initialize diagnostics.
- 5 Connect to User tag DB; upon failure log Event.
- 6 Connect to MCP Interface; upon failure log Event. Tell MCP Interface "not running", "not ready".
- 7 Parse configuration.
- 8 Verify all tag pointers from configuration for validity (tags all defined, all exist in User tag DB); upon first failure log Event.
- 9 Create internal file for configuration from our parsed configuration.
- 10 Initialize diagnostic tag pointers and diagnostic values.
- 11 Opens internal file and the GOOSE socket; upon failure of either log Event.
- 12 Prepare reportids; upon failure log Event.
- 13 Tell MCP Interface ready.
- 14 Start the Diagnostics thread.
- 15 Initialize global GOOSE management.
- 16 Tell MCP Interface running.

All conditions causing the driver not to start are identified above by the log Event actions.

IEC 61850 client firmware operating sequence:

- 1 If not connected to a configured IED, attempt to connect every 5 seconds. Once connected, attempt to identify with the IED every 50 ms. If identify fails 10 times, disconnect from the IED and attempt to reconnect every 5000 ms.
- 2 Subscribe to any GOOSE messaging configured for this IED. Ensure match of each element's type id and the GOOSE confRev. Set failure flag if no match is found.
- 3 Enable any Reports configured for this IED. If the enable fails for whatever reason, such as a mismatch of confRev, then the Report is not enabled and not attempted again. Otherwise the Enable continues to be attempted every 60 seconds. Once connected, perform a General Interrogation to receive all data values of the Report, if that TrgOp was enabled for that Report. Once connected, perform a General Interrogation to receive all data values of the Report, if that TrgOp was enabled for that report.
- 4 Process MMS reads and MMS writes.

The IEC 61850 client driver attempts to reconnect to any disconnected IEDs every 5000 milliseconds.

Configured GOOSE messages for an IED are not re-subscribed upon a reconnect. There is no need, because GOOSE messages are of an EtherType packet, not an IP packet. GOOSE messages are addressed by MAC address, not IP address. Essentially it is a broadcast message.

Configured Reports for an IED return to a **Must try to Enable** state, and follow the startup sequence.

If MMS Reset (meaning the stream is out of step) is issued by either the gateway or the IED, then the gateway issues a disconnect and reconnect to the IED. If the IEC 61850 driver receives a short packet (short MMS read) then it issues a MMS Reset.

5.6 IEC 61850 Standard Introduction

IEC 61850 is primarily focused on electrical utility stations and substations. Substations can be categorized as distribution or transmission substations. Distribution substations generally have feeder equipment in the voltage range of 30 kV and under. The one or two incoming feeders are generally at a transmission voltage level. A transmission substation would have feeder equipment at a transmission voltage level, generally 100 kV and above.

Although IEC 61850 applications are primarily in electrical substations, there are applications in the oil and gas industries as well (co-gen sites).

5.6.1 Integrating the Substation

The logical nodes can inter-operate with other logical nodes by interpreting and processing compatible services and data classes. This table has been taken directly from the IEC 61850 Standard document.

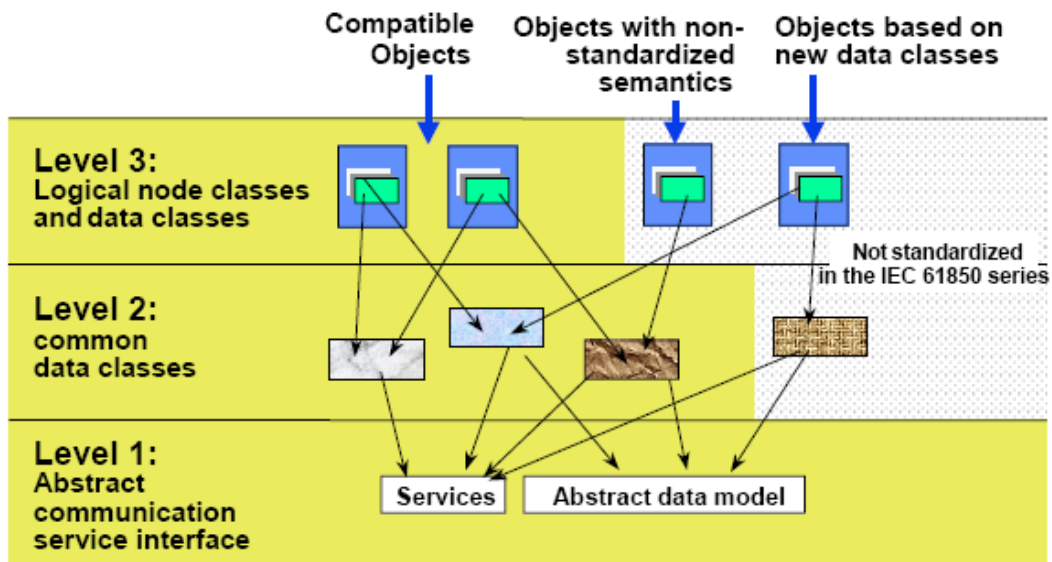

Typical Substation Automation System. This diagram has been taken directly from the IEC 61850 Standard document.

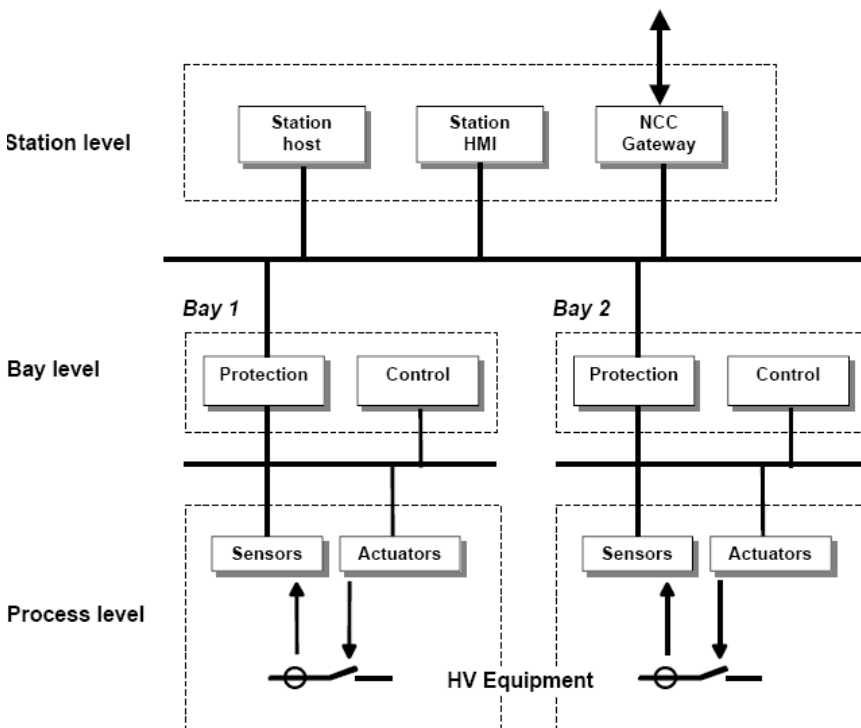

- In a typical substation, all Data Attributes from each of the IEDs are desired at the PLC.
- Data is desired at the Station PLC (for decision making) and at the SCADA system.
- Data gathered for condition based monitoring purposes, to detect point of degradation of an aging mechanism.
- Examples of data needs: checking SF₆ gas insulation temperature.
- Alarm data with high precision of accuracy needed, to determine which IED alarmed (GOOSE'd) first.
- Control of bay-level switchgear for interlocking and maintenance purposes.

5.6.2 IEC 61850 Benefits

- Object-oriented data model
- Introduces Logical Nodes (LNs) for formally defining functions (for example XCBR = Circuit Breaker, XSWI = Isolator or earthing switch)
- LN defines standardized access to its data
- Performance guidelines per LN strongly influence the communication system structure
- Communication technology based upon standardized rules, not rules stated by chance by customer specifications
- Strong formal description of automation system, which is key for specification, design, and engineering
- Self-describing (Example: vendor name plate information)

5.6.3 IEC 61850 Communication Features

- Specific Communication Service Mapping (SCSM) is done via MMS (ISO/IEC 9506-1 and ISO/IEC 9506-2) and to ISO/IEC 8802-3. This is part IEC 61850-8-1 of the standard.
- Specific Communication Service Mapping (SCSM) for Sampled Values is over ISO/IEC 8802-3. This is part IEC 61850-9-2 of the standard.

Ethernet has proven performance for the demands of IEC 61850. For best performance, it is recommended that you use Ethernet switches, rather than hubs.

5.6.4 SCL / Standardized Data Exchange

IEC 61850's SCL (Substation Configuration Description Language) introduces a powerful feature for substation automation. It provides a vendor-independent representation of the substation's configuration. For example, XCBR is a circuit breaker, no matter who the vendor is, what the country the vendor is from, what country the system integrator is from, where the installation is.

IEC 61850 has a number of SCL-type files:

- SSD for substation specification description
- SCD for the substation configuration description
- ICD for IED capability description (like a configuration template for the IED)
- CID for the configured IED description

Note: This concept is key for meeting engineering challenges.

5.6.5 Advantages to Substation Configuration Description Language (SCL)

- ICD files list the functionality (via Logical Nodes) and data objects (Data Attributes) available for the IED
- The device's ICD files list the communication service capabilities of the IED, for example, is File Transfer supported?
- The ICD tells what's in the DATA-SETS.
- It lists the Report Control Blocks, and if the DATA-SET for it can be dynamically assigned.
- When gathering data from the IED for archiving purposes, the database is simply built because of the descriptive names coming from the devices.

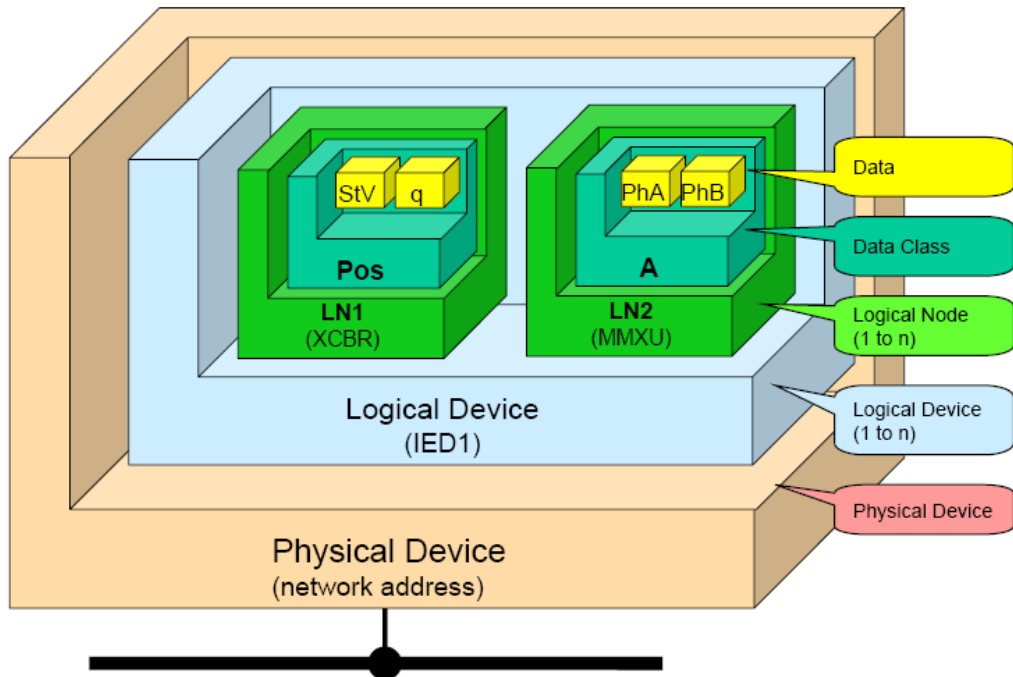

© Siemens Power Transmission & Distribution, 2002

14

IEC 61850-7-2 Overview Diagram:

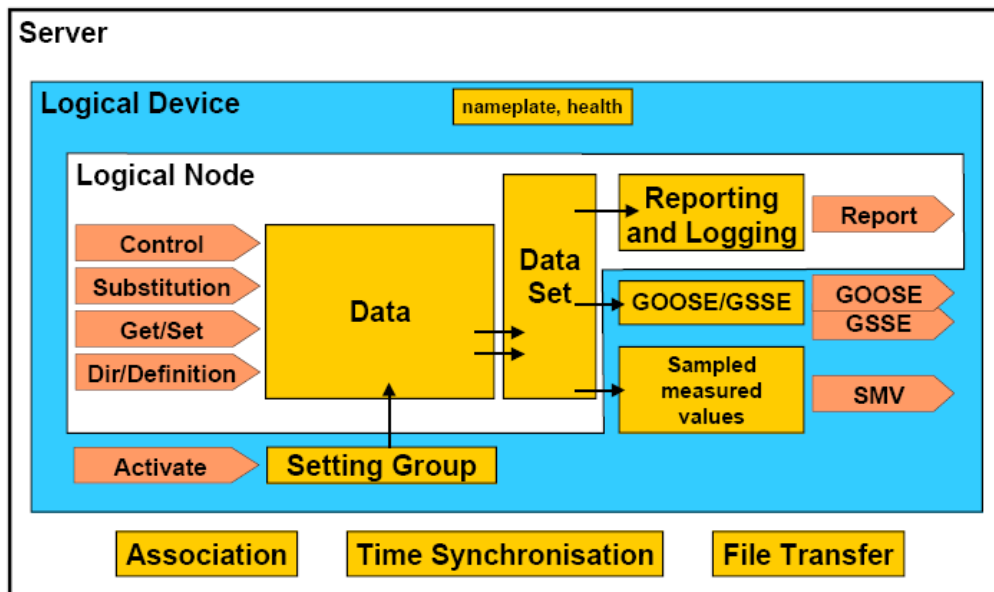

IEC 964/03

Information Exchange Diagram:

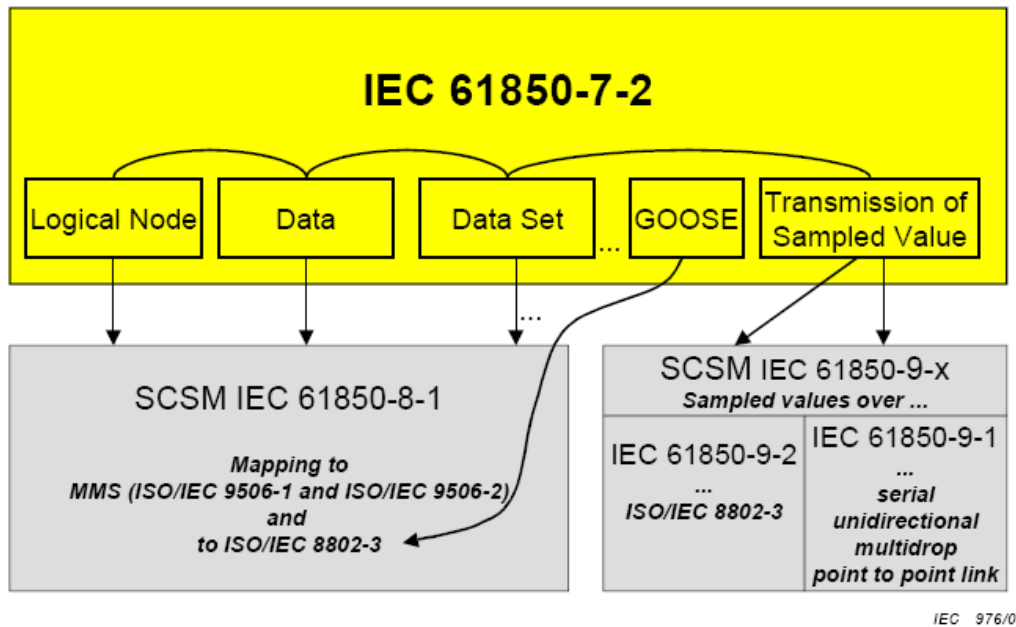

These diagrams have been taken directly from the IEC 61850 Standard document.

5.6.6 Report Control Block BRCB (Clause 14)

Buffered Report Control Block (BRCB)

A Buffered Report Control Block (BRCB) is associated with a DATA-SET. BRCB data is queued up, or buffered, in the IED, and sent sequentially to the connected IEC 61850 client. The size of the buffer is defined by the IED. BRCB is used so that data is not lost due to communication control or loss of connection. There are procedures required around the reporting, and the IED may only report to one client.

Note: Since the buffered data is eventually sent via EtherNet/IP communications in this product, only one buffered report is sent. If multiple IEC 61850 buffered reports come in during a single RPI time, the last report is only updated in the EtherNet/IP side of communications.

Unbuffered Report Control Block (URCB)

An Unbuffered Report Control Block (URCB) is associated with a DATA-SET. URCB data is sent immediately to the connected IEC 61850 client. If the transport data flow is not fast enough to support the movement of this data, some may be lost. The IED can have multiple instances of the URCB data, and manages the separation of the instances to the IEC 61850 clients.

5.6.7 GSE (Clause 15)

Peer-to-peer messaging is accomplished with two messages types that are slightly different. The messages, GOOSE and GSSE, are collectively referred to as GOOSE. They are accomplished via a publisher-subscriber model. The difference is that GOOSE data is exchanged via DATA-SET and GSSE provides a simple list of status information. The gateway supports GOOSE messages only. As an IEC 61850 client, the PLX82-EIP-61850 subscribes to the GOOSE messages published by the IED. GOOSE messages can help the equipment prevent interlock (the IED prevents harming the operator or itself).

5.6.8 Control (Clause 17)

There are 5 types of control models defined:

- Status-only
- Direct-with-normal-security
- Select Before Operate SBO-with-normal-security
- Direct-with-enhanced-security
- Select Before Operate SBO-with-enhanced-security

Enhanced Security tends to be used only for high-voltage sites.

SBO includes a Select step, used to check that the control may be valid and to eventually lock a resource.

Direct Control with Normal Security

Direct control with normal security is commonly used for operations that act on local data (such as a LED test) or on data for which return information is not supervised (for example switch on a heating). It uses the **Operate** and **TimeActivatedOperate** services. This diagram and text has been taken directly from the IEC 61850 Standard document.

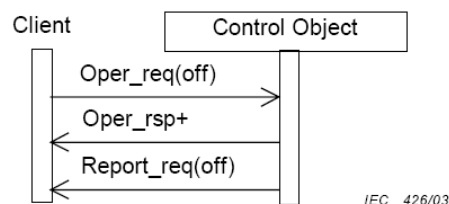

Figure 31 – Direct control with normal security

Procedure

On receipt of an **Operate** request, the control object shall check validation of the control execution.

- If not successful, the control object shall issue a negative response to the requesting client.
- If successful, the control object shall issue a positive response to the requesting client and causes the requested action.

The new status may be reported by the **Report** service (see reporting model).

SBO (Select Before Operate) with Normal Security

SBO control with normal security first verifies that the Data Attribute is not currently selected by a different client, that it is operable, and that the operation is not restricted. If this is verified, then the Operate request should proceed. It uses these services:

- Select
- Cancel
- Operate
- TimeActivatedOperate

SBO with normal security Data Attributes are generally controllable single point (SPC) attribute types. These are things such as:

- Run Diagnostics
- Trigger recorder
- Reset recorder memory
- Clear memory

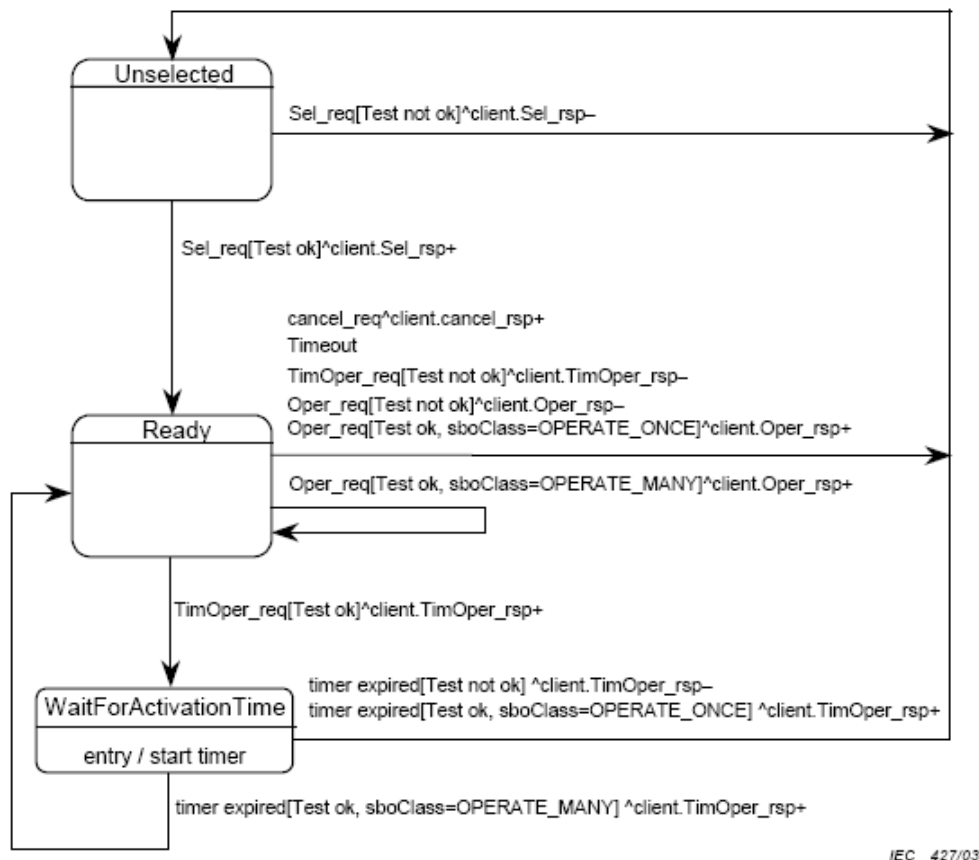

IEC 427/03

NOTE This state machine is compatible to the SBO control model defined in UCA™.2.

Figure 32 – State machine of SBO control with normal security

Procedure

- a) On receipt of a **Select** request, the control object shall determine if the client has appropriate access authority, that the control object is not currently selected by a different client, and that the device represented by the associated **LOGICAL-NODE** is operable and is not tagged so as to restrict operation.
 - If the **Select** operation is not valid, the control object shall issue a negative response to the requesting client.
 - If the **Select** operation is valid, the control object shall issue a positive response to the requesting client, shall change the state to ready and starts a deselect timer for either the interval defined by the SelTimOut attribute or, if unimplemented, some locally determined duration.
- b) If the deselect timer expires before an **Operate** request on one or more of the other control components shall be requested by the selecting client, the control object shall change the state to unselected.
- c) If an **Operate** request is received from the selecting client while the state is not Ready for that client, the operation shall be denied.
- d) On receipt of an **Operate** request, the control object shall check validation of the control execution.
 - If not successful, the control object shall issue a negative response to the requesting client.
 - If successful, the control object shall issue a positive response to the requesting client and shall cause the requested action by activating a binary output (or sending an equivalent signal on a process bus). The control object shall turn to the state WaitForActivationTime.

This diagram and text has been taken directly from the IEC 61850 Standard document.

Direct Control with Enhanced Security

Direct control with enhanced security is commonly used to start actions at the server from a client. However, multiple clients can perform conflicting actions to the server without prevention in this model. It uses these services:

- Operate
- TimeActivatedOperate
- Command-Termination

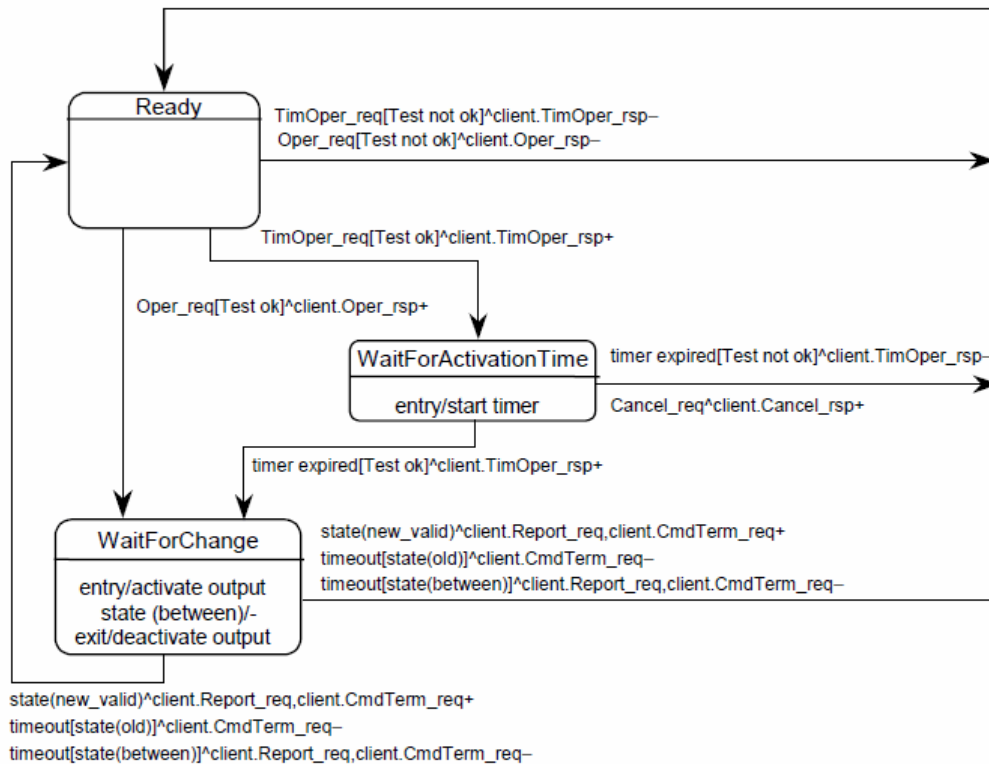

IEC 428/03

Figure 33 – State machine of direct control with enhanced security

This diagram has been taken directly from the IEC 61850 Standard document.

SBO (Select Before Operate) with Enhanced Security

SBO control with enhanced security is commonly used for allowing only one client to control the server at a time. It uses these services:

- SelectWithValue
- Cancel
- Operate
- TimeActivatedOperate
- Command-Termination

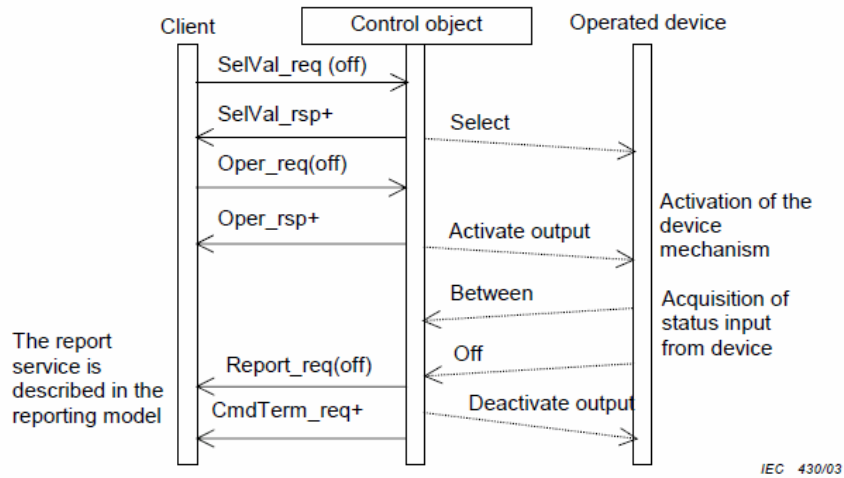

Figure 35 – Select before operate with enhanced security – positive case

NOTE The dashed lines in Figures 35 and 36 indicate that these "services" are local and not visible at the communication level.

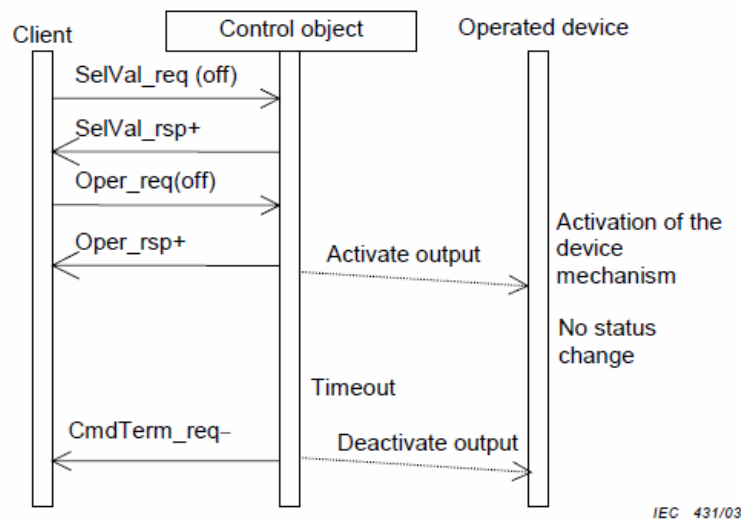

Figure 36 – Select before operate with enhanced security – negative case (no status change)

Procedure

- a) On receipt of a **SelectWithValue** request, the control object shall determine if the client has appropriate access authority, that the control object is not currently selected by a different client, and that the device represented by the associated **LOGICAL-NODE** is operable and is not tagged so as to restrict operation.
 - If the **SelectWithValue** operation is not valid, the control object shall issue a negative response to the requesting client.
 - If the **SelectWithValue** operation is valid, the control object shall issue a positive response to the requesting client, shall change the state to ready and starts a deselect timer for either the interval defined by the **sboTimOut** attribute or, if unimplemented, some locally determined duration.

- b) If the deselect timer expires before an **Operate** request on one or more of the other control components shall be requested by the selecting client, the control object shall change the state to unselected.

- c) If an **Operate** request is received from the selecting client while the state is not Ready for that client, the operation shall be denied.

- d) On receipt of an **Operate** request, the control object shall check validation of the control execution.
 - If not successful, the control object shall issue a negative response to the requesting client.
 - If successful, the control object shall issue a positive response to the requesting client and shall cause the requested action by activating a binary output (or sending an equivalent signal on a process bus). The control object shall turn to the state **WaitForChange**.
 - The control object supervises the change of the device status.
 - As soon as the status of the controlled device has changed, the control object shall report the new status using the report service of the reporting model.
 - If the status has not changed to the wanted value after a certain time, the control object shall issue a **CommandTermination** negative as soon as the output is deactivated.
 - When the object indicates the wanted position before expiration of a timer, the control object shall issues a **CommandTermination** positive as soon as the output is deactivated.

- e) When leaving the **WaitForChange** state, one of the following procedures shall be performed based on the SBO-Select Class.
 - If the value of the **sboClass** attribute is **operate-once**, the new state shall be unselected.
 - If the value of the **sboClass** attribute is **operate-many**, the new state shall be Ready.

The last action shall be the command termination (**CmdTerm**) service.

These diagrams and text have been taken directly from the IEC 61850 Standard document.

5.6.9 Naming Conventions (Clause 19)

This section discusses the gateway’s implementation of IEC 61850-7-2 Clause 19: Naming Conventions.

The ProSoft EIP-61850 Configuration Manager follows the naming conventions in accordance with the IEC 61850 standards, and they are also transferred into EtherNet/IP.

The *IEC 61850 Mapping Tool* window uses standard naming conventions:

- Logical Node
- Data Object
- Data Attribute
- Functional Constraint
- 61850 Path

Extended into:

- TagName

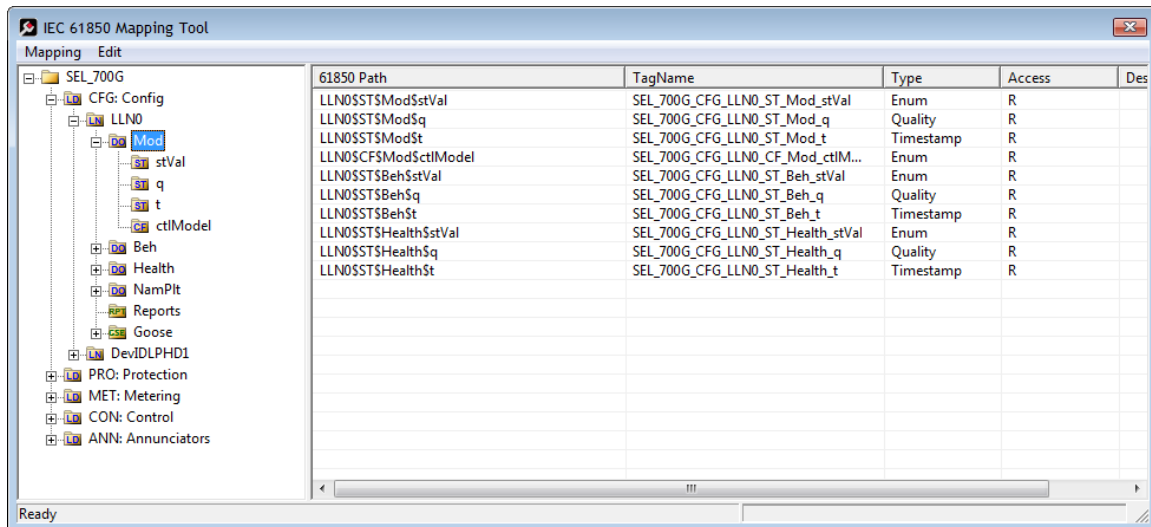

References to data for class naming and class specialization are as defined in the IEC 61850 Standard. They are:

The classes for **DATA**, **common DATA**, **compatible DATA**, and **compatible LOGICAL-NODE** defined in IEC 61850-7-x make use of the following specializations:

- IEC 61850-7-3 common **DATA** classes (for example, **DPC**) are specializations of the class **DATA** of IEC 61850-7-2
- IEC 61850-7-4 compatible **DATA** classes (for example, **Pos** – position) are specializations of IEC 61850-7-3 common **DATA** classes (for example, **DPC** – controllable double point)
- IEC 61850-7-4 compatible **LOGICAL-NODE** classes (for example, **XCBR**) are specializations of the **LOGICAL-NODE** class of IEC 61850-7-2

The preceding text has been taken directly from the IEC 61850 Standard document.

5.7 Usage Examples

5.7.1 Rockwell Automation PLC Device Configuration

Configuration

After the IEC 61850 Data Attributes to be mapped in the gateway have been chosen, then double-click the **ETHERNET/IP DEVICE** bubble.

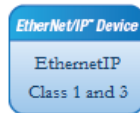

This brings up the *EtherNet/IP Mapping* window.

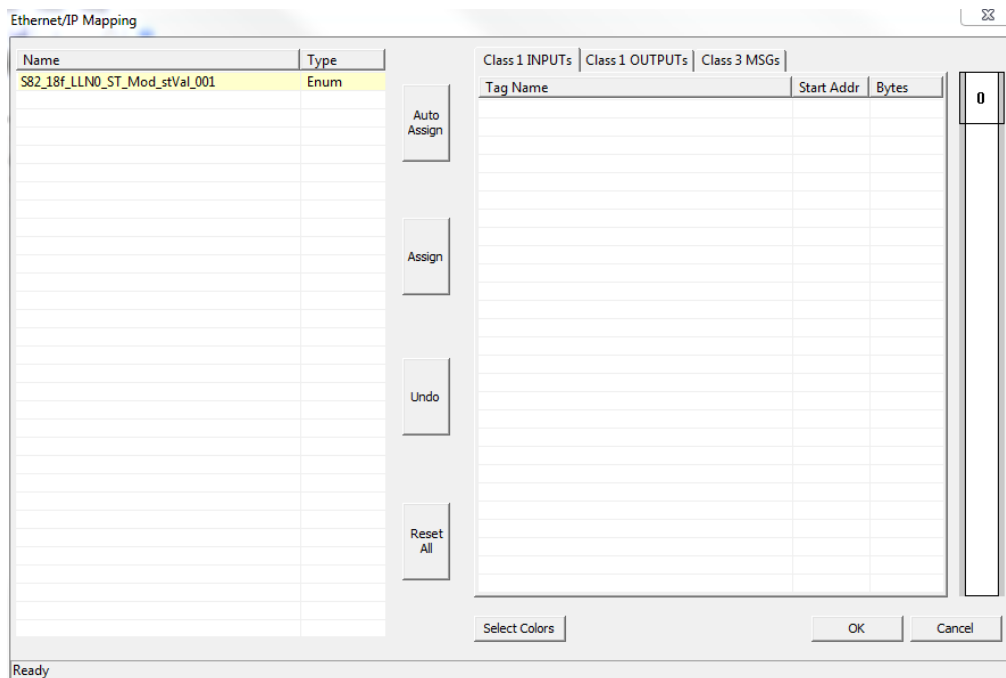

On the *EtherNet/IP Mapping* window the Data Attribute automatically appears on the left-hand side of the window. The right-hand side of the window is for mapping IED data to the gateway's EtherNet/IP adapter. This is the data the gateway exchanges with the PLC.

Assigned Tags View

At the bottom of the *EtherNet/IP Mapping* window, the *Assigned Tags* window shows how the tags are mapped.

The *Assigned Tags* window gives you information about all of the tags mapped to this PLC. The fields are:

- Device Path
- Tag Name
- Type
- Access
- Description
- EIP Class
- Conn No.
- Byte Offset
- Attribute

Device Path	Tag Name	Type	Access	Description	EIP Class	Conn No.	Byte Offset	Attribute
LLN0SST\$BehSt	S82_18f.LLN0.ST_Beh_t_007	Timestamp	R		Class 1	6	320	--
LLN0SST\$HealthStVal	S82_18f.LLN0.ST_Health_st...	Enum	R		Class 1	6	328	--
LLN0SST\$HealthSq	S82_18f.LLN0.ST_Health_q...	Quality	R		Class 1	6	330	--
LLN0SST\$HealthSt	S82_18f.LLN0.ST_Health_t...	Timestamp	R		Class 1	6	332	--
LLN0SDC\$NamPit\$vendor	S82_18f.LLN0.DC_NamPit_...	VisString255	R		Class 3	-	--	1
LLN0SDC\$NamPit\$swRev	S82_18f.LLN0.DC_NamPit_...	VisString255	R		Class 3	-	--	2
LLN0SDC\$NamPit\$Id	S82_18f.LLN0.DC_NamPit_...	VisString255	R		Class 3	-	--	3
LLN0SDC\$NamPit\$configRev	S82_18f.LLN0.DC_NamPit_...	VisString255	R		Class 3	-	--	4
LLN0SEX\$NamPit\$IdNs	S82_18f.LLN0.EX_NamPit_...	VisString255	R		Class 3	-	--	5
LLN0SST\$Loc\$stVal	S82_18f.LLN0.ST_Loc_stVal...	BOOLEAN	R		Class 1	6	340	--
LLN0SST\$Loc\$Sq	S82_18f.LLN0.ST_Loc_q_017	Quality	R		Class 1	6	341	--

DEVICE PATH: This shows the 61850 logical path.

TAG NAME: This is the tag name for this IEC-61850 Data Attribute, as named automatically by ProSoft EIP-61850 Configuration Manager, or you can optionally change it in the *IEC 61850 Mapping Tool* window.

TYPE: This is the IEC-61850 data type of the tag.

IEC 61850 Data Type	Number of Bytes
BOOLEAN	1
INT8	1
INT16	2
INT24	4
INT32	4
INT128	Not Supported
INT8U	1
INT16U	2
INT24U	4
INT32U	4
FLOAT32	4
FLOAT64	Not Supported
Enum	2
Dbpos	2
Tcmd	1
Quality	2

IEC 61850 Data Type	Number of Bytes
Timestamp	8
VisString32	102
VisString64	102
VisString255	102
Octet64	64
EntryTime	4
Unicode255	102
BitString	1
Check	1

When you choose **EXPORT AOI FILES**, the ProSoft EIP-61850 Configuration Manager prompts you for a location of the AOI for each IED defined in the project. The Add-On Instruction file (.L5X) contains Tag Names, Data Types and the logic rungs to be used in an RSLogix 5000 project.

5.7.2 Energy Application

- The IEC 61850 protocol specification was written with electrical substations in mind.
- The PLC wants all data you have defined as relevant, including time stamp and quality bits from all IEDs. It sends this data to a dispatching system. In this case, the PLC is like a data concentrator from the substation to the dispatching center.
- You want Open and Close control with tight time constraints. The controls need to be as fast as possible.

One typical example for this kind of application might be 20 IEDs, where the gateway needs to send all the relevant data from all 20 IEDs to the PLC. Typically, this would be approximately 250 data points per IED.

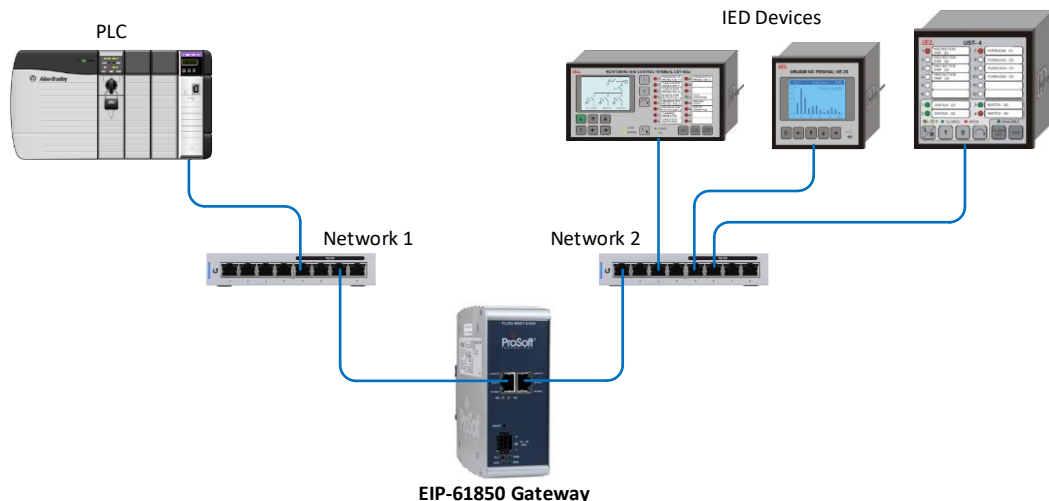

5.7.3 Monitoring

In a typical monitoring application, several types of actions may be needed:

- Automatic action required: monitoring the currents and voltages and the system taking an immediate automatic action, like tripping a circuit breaker.
- Operator action required: monitoring of the current temperature of gas in a gas insulator around a circuit breaker. This could result in actions initiated by an operator, such as sending maintenance people on-site.
- Post-mortem analysis: monitoring and collecting information about equipment condition, to be analyzed by a specific tool, resulting in recommendations for maintenance.

5.7.4 Measuring and Metering

Statistical evaluation of measured quantities, determining minimum and maximum values over a period of time, and creating history of this information, such as:

- currents, voltage, power and impedance in a three phase system (MMXU)
- calculation of energy in a three phase system (MMTR)
- calculation of harmonics and interharmonics (MHA)

5.7.5 Supervision and Protection

Evaluating measured quantities for the purpose of detecting dangerous situations, such as

- Supervision of the quantities of an insulation medium in Sxxx logical nodes (Sxxx = logical nodes for monitoring by sensors = **SIMS, SARC, and SPDC**)
- Processing of quantities in Pxxx logical nodes (Pxxx = logical nodes for protection = **PTEF, PZSU, PDIS, PVPH, PTUV, PDPR, PWDE, PUCP, PUEX, PPBR, PPBV, PMSU, PTTR, PROL, PSOL, PIOC, PTOC, PVOC, PPFR, PTOV, PDOV, PVCB, PHIZ, PREF, PSEF, PITF, PDOC, PDEF, PDCO, PPAM, PFRQ, PDIF, PPDF, PLDF, PNDF, PTDF, PBDF, PMDF, and PGDF**)

Upon detection of a dangerous situation, the system then initiates action.

6 List of Abbreviations

Note: Some abbreviations have more than one meaning in the IEC 61850 specification. These are marked with an asterisk (*).

A	Current in Amperes (Amps) *	IEC 61850-7-4
A	Application (p. 983) *	IEC 61850-8-1
a.c.	alternating current	IEC 61850-3
AA	Application Association	IEC 61850-7-1
ACD	Activation information of Directional protection	IEC 61850-7-3
acs	Access	IEC 61850-7-4
ACSE	Application Common Service Element	IEC 61850-8-1
ACSI	Abstract Communication Service Interface	IEC 61850-1
ACT	Protection ACTivation information	IEC 61850-7-3
Acu	Acoustic	IEC 61850-7-4
Age	Ageing	IEC 61850-7-4
AIS	Air Insulated Switchgear	IEC 61850-1
Alm	Alarm	IEC 61850-7-4
ALPDU	Application Layer Protocol Data Unit	IEC 61850-9-1
Amp	Current – non-phase related	IEC 61850-7-4
An	Analog	IEC 61850-7-4
ANCR	Logical node - Earth fault neutralizer control (control of Petersen coil)	IEC 61850-5
Ang	Angle	IEC 61850-7-4
APCI	Application Protocol Control Information	IEC 61850-9-2
APDU	Application Protocol Data Unit	IEC 61850-9-2
API	Application Program Interface	IEC 61850-7-1
APPID or AppID	Application Identification	IEC 61850-7-1, IEC 61850-8-1
A-Profile	Application Profile	IEC 61850-8-1
ARCO	Logical node - Reactive control	IEC 61850-5
ASDU	Application Service Data Unit	IEC 61850-1
ASG	Analog SettinG	IEC 61850-7-3
ASN.1	Abstract Syntax Notation One	IEC 61850-7-1
ATCC	Logical node - Automatic tap changer control	IEC 61850-5
AUI	Attachment Unit Interface, Transceiver, or connecting cable	IEC 61850-9-1
Auth	Authorization	IEC 61850-7-4
Auto	Automatic	IEC 61850-7-4
Aux	Auxiliary	IEC 61850-7-4
Av	Average	IEC 61850-7-4
AVCO	Logical node - Automatic voltage control	IEC 61850-5
AZVT	Logical node - Zero-voltage tripping	IEC 61850-5
B	Bushing	IEC 61850-7-4
Bat	Battery	IEC 61850-7-4
BDA	Basic Data Attribute, that is not structured	IEC 61850-6
Beh	Behavior	IEC 61850-7-4

BER	Basic Encoding Rules ASN.1	IEC 61850-9-1
Bin	Binary	IEC 61850-7-4
Blk	Block, or Blocked	IEC 61850-7-4
Bnd	Band	IEC 61850-7-4
Bo	Bottom	IEC 61850-7-4
BOOLEAN		IEC 61850-7-3, IEC 61850-7-2
BR	Functional constraint - Buffered report	IEC 61850-7-2
BRC	Buffered Report Control class	IEC 61850-7-2
BRCB	Buffered Report Control Block	IEC 61850-7-2
BS	Bitstring	IEC 61850-9-2
BufTm		IEC 61850-7-1
c	Conditional support. The item shall be implemented if the stated condition exists	IEC 61850-9-2
CAD	Computer Aided Design	IEC 61850-4
CALH	Logical node - Alarm handling (creation of group alarms and group events)	IEC 61850-5
Cap	Capability	IEC 61850-7-4
Capac	Capacitance	IEC 61850-7-4
Car	Carrier	IEC 61850-7-4
CB	Circuit Breaker	IEC 61850-1
CBB	Conformance Building Block	IEC 61850-8-1
CD ROM	Compact Disc Read Only Memory	IEC 61850-4
CDC	Common Data Class	IEC 61850-1
CDCAName	Common Data Class Attribute Name	IEC 61850-8-1
cdcNs	common data class Name space	IEC 61850-7-3
CDCNSpace	Common Data Class Name Space	IEC 61850-7-2
CE	Cooling Equipment	IEC 61850-7-4
Cf	Crest factor	IEC 61850-7-4
CF	Functional constraint - Configuration	IEC 61850-7-2
Cfg	Configuration	IEC 61850-7-4
CFI	Canonical Format Identifier	IEC 61850-9-2
CG	Core Ground	IEC 61850-7-4
Ch	Channel	IEC 61850-7-4
Cha	Charger	IEC 61850-7-4
Chg	Change	IEC 61850-7-4
Chk	Check	IEC 61850-7-4
Chr	Characteristic	IEC 61850-7-4
CILO	Logical node - Interlocking function (at station level and/or bay level)	IEC 61850-5
CIM	Common Information Model of IEC 61970-301	IEC 61850-6
Cir	Circulating	IEC 61850-7-4
CL	Connectionless	IEC 61850-8-1
Clc	Calculate	IEC 61850-7-4
Client-CR	Client Conformance Requirement	IEC 61850-8-1
Clk	Clock or Clockwise	IEC 61850-7-2
ClS	Close	IEC 61850-7-4
Cnt	Counter	IEC 61850-7-4
CO	Functional constraint - Control *	IEC 61850-7-2

CO	Connection Oriented (p. 983) *	IEC 61850-8-1
CODED ENUM	Ordered set of values, defined where type is used (custom extensions not allowed)	IEC 61850-7-3, IEC 61850-7-2
Col	Coil	IEC 61850-7-4
ConfRev	Configuration revision	IEC 61850-7-1
ConNode	Connectivity Node	IEC 61850-6
Cor	Correction	IEC 61850-7-4
CPOW	Logical node - Point-on-wave breaker controller (controls a circuit breaker with point-on-wave switching capacity)	IEC 61850-5
CRC	Cyclic Redundancy Check	IEC 61850-2
Crd	Coordination	IEC 61850-7-4
Crv	Curve	IEC 61850-7-4
CSMA/CD	Carrier Sense Multiple Access/Collision Detection	IEC 61850-9-1
CSWI	Logical node - Switch controller (controls any switchgear, i.e. the devices described by XCBR and XSWI)	IEC 61850-5
CT	Current Transformer/Transducer	IEC 61850-4
Ctl	Control	IEC 61850-7-4
Ctr	Center	IEC 61850-7-4
Cyc	Cycle	IEC 61850-7-4
d.c.	direct current	IEC 61850-3
DA	Data Attribute	IEC 61850-7-2
DAI	Instantiated Data Attribute	IEC 61850-6
DAT	Data Attribute Type	IEC 61850-7-2
dataNs	Data Name Space	IEC 61850-7-3
DataRef	Data Reference	IEC 61850-7-2
DatAttrRef	Data Attribute Reference	IEC 61850-7-2
DatSet	Data set	IEC 61850-7-1
DAType	Data Attribute type	IEC 61850-7-1
DC	Functional constraint - Description	IEC 61850-7-2
dchg	Trigger option for data-change	IEC 61850-7-1
Dea	Dead	IEC 61850-7-4
Den	Density	IEC 61850-7-4
Det	Detected	IEC 61850-7-4
DEX or DExt	De-Excitation	IEC 61850-7-4
DF	Data Frame	IEC 61850-9-1
Diag	Diagnostics	IEC 61850-7-4
Dif	Differential/Difference	IEC 61850-7-4
Dir	Directional	IEC 61850-7-4
Dis	Distance	IEC 61850-7-4
DI	Delay	IEC 61850-7-4
Dlt	Delete	IEC 61850-7-4
Dmd	Demand	IEC 61850-7-4
Dn	Down	IEC 61850-7-4
DNA	Dynamic Namespace Attribute	IEC 61850-8-1
DO	Data Object	IEC 61850-1
DOI	Instantiated Data Object	IEC 61850-6
DORef	Data Object Reference	IEC 61850-6
DPC	Double Point Control	IEC 61850-7-2
DPS	Double Point Status information	IEC 61850-7-1

DPSCO	Double Point Controllable Status Output	IEC 61850-7-4
DQ0	Direct, Quadrature and Zero (0) axis quantities	IEC 61850-7-4
Drag	Drag Hand	IEC 61850-7-4
Drv	Drive	IEC 61850-7-4
DS	Data Set *	IEC 61850-7-2
DS	Device State (p. 867) *	IEC 61850-7-4
Dsch	Discharge	IEC 61850-7-4
DSG	Data Set Group	IEC 61850-9-1
DTD	Document Type Definition	IEC 61850-6
dupd	trigger option for data update	IEC 61850-7-2
Dur	Duration	IEC 61850-7-4
DUT	Device Under Test	IEC 61850-10
EC	Earth Coil	IEC 61850-7-4
ECT	Electronic Current Transformer or transducer	IEC 61850-9-1
EE	External Equipment	IEC 61850-7-4
EF	Earth Fault	IEC 61850-7-4
EMC	Electro Magnetic Compatibility	IEC 61850-1
EMI	Electro Magnetic Interference	IEC 61850-1
Ena	Enabled	IEC 61850-7-4
ENUMERATED	Ordered set of values, defined where type is used (custom extensions allowed)	IEC 61850-7-3, IEC 61850-7-2
EPRI	Electric Power Research Institute	IEC 61850-1
Eq	Equalization or Equal	IEC 61850-7-4
Ev	Evaluation	IEC 61850-7-4
EVT	Electronic Voltage Transformer or transducer	IEC 61850-9-1
Ex or Ext	Excitation *	IEC 61850-7-4
EX	Functional constraint - Extended definition *	IEC 61850-7-2
Ex	External (p. 867) *	IEC 61850-7-4
Exc	Exceeded	IEC 61850-7-4
Excl	Exclusion	IEC 61850-7-4
F/S	Functional Standard	IEC 61850-8-1
FA	Fault Arc	IEC 61850-7-4
Fact	Factor	IEC 61850-7-4
Fan	Fan	IEC 61850-7-4
FAT	Factory Acceptance Test	IEC 61850-4
FC	Functional Constraint	IEC 61850-7-1
FCD	Functionally Constrained Data	IEC 61850-7-2
FCDA	Functionally Constrained Data Attribute	IEC 61850-7-2
fchg	Trigger option for filtered-data change	IEC 61850-7-2
FD	Fault Distance	IEC 61850-7-4
FLOAT32	Range of values and precision as specified by IEEE 754 single-precision floating point	IEC 61850-7-3
FLOAT64	Not Supported	Not Supported
Flt	Fault	IEC 61850-7-4
Flw	Flow	IEC 61850-7-4
FPF	Forward Power Flow	IEC 61850-7-2
Fu	Fuse	IEC 61850-7-4
Fwd	Forward	IEC 61850-7-4

GAPC	Logical node - Automatic process control (a generic, programmable LN for sequences, unknown functions, etc.)	IEC 61850-5
Gen	General	IEC 61850-7-4
GGIO	Logical node - Generic I/O	IEC 61850-5
GI	General interrogation	IEC 61850-7-1, IEC 61850-7-2
GIS	Gas Insulated Switchgear	IEC 61850-1
Gn	Generator	IEC 61850-7-4
Gnd	Ground	IEC 61850-7-4
GO	Functional constraint - Goose control	IEC 61850-7-2
GoCB	Goose Control Block	IEC 61850-7-2
GoEna		IEC 61850-7-1
GOMSFE	Generic Object Models for Substation and Feeder Equipment	IEC 61850-1
GOOSE	Generic Object Oriented Substation Events	IEC 61850-5
GPS	Global Positioning System (time source)	IEC 61850-5
Gr	Group	IEC 61850-7-4
Grd	Guard	IEC 61850-7-4
Gri	Grid	IEC 61850-7-4
GS	Functional constraint - GSSE control	IEC 61850-7-2
GSAL	Logical node - General security application	IEC 61850-5
GsCB	GSSE Control Block	IEC 61850-7-2
GSE	Generic Substation Event	IEC 61850-7-2
GSEM	Generic Substation Event Model	IEC 61850-7-2
GSSE	Generic Substation Status Event	IEC 61850-7-2
GTES	Logical node - Test generator	IEC 61850-5
H	Harmonics (phase related)	IEC 61850-7-4
H2	Hydrogen	IEC 61850-7-4
H2O	Water	IEC 61850-7-4
Ha	Harmonics (non-phase related)	IEC 61850-7-4
Hi	High or Highest	IEC 61850-7-4
HMI	Human Machine Interface	IEC 61850-3
HP	Hot Point	IEC 61850-7-4
Hz	Hertz – frequency cycles/second	IEC 61850-7-4
i	Out-of-scope: The implementation of the item is not within the scope of this standard	IEC 61850-9-2
I/O	Status Inputs/Output contacts, or channels	IEC 61850-5
IARC	Logical node - Archiving	IEC 61850-5
ICD	IED Configuration Description	IEC 61850-10
ID	Identifier	IEC 61850-6
IEC	International Electrotechnical Commission	IEC 61850-1
IED	Intelligent Electronic Device	IEC 61850-1
IEEE	Institute of Electrical and Electronic Engineers	IEC 61850-1
IETF	Internet Engineering Task Force	IEC 61850-8-1
IF	Interface (serial)	IEC 61850-5
IHMI	Logical node - Operator interface (control local at bay level/control at station level)	IEC 61850-5
Imb	Imbalance	IEC 61850-7-4
Imp	Impedance (non-phase related)	IEC 61850-7-4
In	Input	IEC 61850-7-4

Ina	Inactivity	IEC 61850-7-4
INC	INteger status – Controllable	IEC 61850-7-3
Incr	Increment	IEC 61850-7-4
Ind	Indication	IEC 61850-7-4
Inh	Inhibit	IEC 61850-7-4
Ins	Insulation	IEC 61850-7-4
Int	Integer	IEC 61850-7-4
INT128	Not Supported	Not Supported
INT16	-32 768 to 32 767	IEC 61850-7-2
INT16U	Unsigned integer, 0 to 65 535	IEC 61850-7-3, IEC 61850-7-2
INT24	-8 388 608 to 8 388 607 (for TimeStamp type)	IEC 61850-7-3, IEC 61850-7-2
INT24U	Unsigned integer, 0 to 16 777 215	IEC 61850-7-2
INT32	-2 147 483 648 to 2 147 483 647	IEC 61850-7-3, IEC 61850-7-2
INT32U	Unsigned integer, 0 to 4 294 967 295	IEC 61850-7-3, IEC 61850-7-2
INT8	-128 to 127	IEC 61850-7-3, IEC 61850-7-2
INT8U	Unsigned integer, 0 to 255	IEC 61850-7-3, IEC 61850-7-2
IntgPd	Integrity Period	IEC 61850-7-1, IEC 61850-7-2
IP	Internet Protocol	IEC 61850-3
ISC	Integer Step Controlled position information	IEC 61850-7-3
ISCSO	Integer Status Controllable Status Output	IEC 61850-7-4
ISI	Integer Status Information	IEC 61850-7-3
ISO	International Organization for Standardization	IEC 61850-1
IT	Current x Time product	IEC 61850-7-4
ITCI	Logical node - Remote control interface or telecontrol interface	IEC 61850-5
ITMI	Logical node - Remote monitoring interface or telemonitoring interface	IEC 61850-5
km	Kilometer	IEC 61850-7-4
L	Lower	IEC 61850-7-4
LAN	Local Area Network	IEC 61850-5
LC	LOG CONTROL Class *	IEC 61850-7-2
LC	Logical Connection (p. 217) *	IEC 61850-5
LCB	Log Control Block	IEC 61850-7-2
LD	Logical Device	IEC 61850-7-1
Ld	Lead	IEC 61850-7-4
LD0	Logical Device Zero (0)	IEC 61850-7-2
LDC	Line Drop Compensation	IEC 61850-7-4
LDCR	Line Drop Compensation Resistance	IEC 61850-7-4
LDCX	Line Drop Compensation Reactance (X)	IEC 61850-7-4
LDCZ	Line Drop Compensation Impedance (Z)	IEC 61850-7-4
LDInst	Instantiated Logical Device	IEC 61850-6
IdNs	logical device Name space	IEC 61850-7-3
LED	Light Emitting Diode	IEC 61850-7-4
Len	Length	IEC 61850-7-4

Lev	Level	IEC 61850-7-4
Lg	Lag	IEC 61850-7-4
LG	Functional constraint - Logging	IEC 61850-7-2
Lim	Limit	IEC 61850-7-4
Lin	Line	IEC 61850-7-4
Liv	Live	IEC 61850-7-4
LLC	Logical Link Control	IEC 61850-9-1
LLN0	Logical Node Zero (0)	IEC 61850-7-1
LLN0	Logical node device	IEC 61850-5
LN	Logical Node	IEC 61850-1
LN Name	Logical Node Name	IEC 61850-7-2
LNC	Logical Node Class	IEC 61850-7-2
LNData	Logical Node Data	IEC 61850-8-1
LNG	Logical Node Group	IEC 61850-7-4
LNInst	Instantiated Logical Node	IEC 61850-6
InNs	logical node Name space	IEC 61850-7-3
Lo	Low	IEC 61850-7-4
LO	LockOut	IEC 61850-7-4
Loc	Local	IEC 61850-7-4
Lod	Load or Loading	IEC 61850-7-4
LogEna		IEC 61850-7-1
LogRef	Log reference	IEC 61850-7-1
Lok	Locked	IEC 61850-7-4
Los	Loss	IEC 61850-7-4
LPDU	Link Protocol Data Unit	IEC 61850-8-1
LPHD	Logical Node PPhysical Device	IEC 61850-7-1
LSAP	Link Service Access Point	IEC 61850-9-2
LSDU	Link layer Service Data Unit	IEC 61850-9-1
Lst	List	IEC 61850-7-4
LTC	Load Tap Changer	IEC 61850-7-4
m	Minutes *	IEC 61850-7-4
M or m	Mandatory (p. 983) *	IEC 61850-7-2, IEC 61850-8-1
M/O	Data Object is Mandatory or Optional	IEC 61850-7-4
M= or m=	Mandatory information that shall be equal the original information supplied in the request	IEC 61850-8-1
MAC	Media Access Control	IEC 61850-9-1
MAU	Medium Attachment Unit (Transceiver)	IEC 61850-9-1
Max	Maximum	IEC 61850-7-4
MC	multicast	IEC 61850-7-1
MCAA	MultiCast Application Association	IEC 61850-7-2
Mem	Memory	IEC 61850-7-4
MHAI	Logical node - Harmonics and interharmonics (for example for power quality purpose)	IEC 61850-5
MICS	Model Implementation Conformance Statement	IEC 61850-10
Min	Minimum	IEC 61850-7-4
MJD	Modified Julian Day	IEC 61850-8-1
MMS	Manufacturing Message Specification (ISO 9506)	IEC 61850-5
MMTR	Logical node - Metering (for commercial purpose)	IEC 61850-5

MMXU	Logical node - Measuring (for operative purpose)	IEC 61850-5
Mod	Mode	IEC 61850-7-4
Mot	Motor	IEC 61850-7-4
ms	Milliseconds	IEC 61850-7-4
MS	Functional constraint - Multicast sampled value control	IEC 61850-7-2
MSQI	Logical node - Sequences and imbalances (for example for stability purpose)	IEC 61850-5
Mst	Moisture	IEC 61850-7-4
MSV	Multicast Sampled Value	IEC 61850-6
MSVC	Multicast Sampled Value Control	IEC 61850-7-2
MSVCB	Multicast Sampled Value Control Block	IEC 61850-7-2
MsvID	ID for MSV (Multicast Sampled Value	IEC 61850-6, IEC 61850-7-1
MT	Main Tank	IEC 61850-7-4
MTTF	Mean Time To Failure	IEC 61850-3
MTTR	Mean Time To Repair	IEC 61850-3
MU	Merging Unit	IEC 61850-9-1
MX	Functional constraint - Measurands (analog values)	IEC 61850-7-2
N	Neutral	IEC 61850-7-4
Nam	Name	IEC 61850-7-4
NCC	Network Control Center	IEC 61850-5
NdsCom		IEC 61850-7-1
Net	Net sum	IEC 61850-7-4
Ng	Negative	IEC 61850-7-4
Nom	Nominal, Normalizing	IEC 61850-7-4
NPL	Name PLate	IEC 61850-7-2
Num	Number	IEC 61850-7-4
O	Optional	IEC 61850-7-2
OCTET STRING	Max. length defined where type is used	IEC 61850-7-3, IEC 61850-7-2
Ofs	Offset	IEC 61850-7-4
Op	Operate/Operating	IEC 61850-7-4
Opn	Open	IEC 61850-7-4
OptFlds	Optional fields	IEC 61850-7-1
OSI	Open Systems Interconnection	IEC 61850-1
Out	Output	IEC 61850-7-4
Ov	Over/Override/Overflow	IEC 61850-7-4
Pa	Partial	IEC 61850-7-4
Par	Parallel	IEC 61850-7-4
PBDF	Logical node - Busbar protection	IEC 61850-5
PC	Physical Connection	IEC 61850-5
Pct	Percent	IEC 61850-7-4
PD	Physical Device	IEC 61850-1
PDCO	Logical node - DC time overcurrent protection	IEC 61850-5
PDEF	Logical node - Directional earth fault protection	IEC 61850-5
PDIF	Logical node - Differential protection	IEC 61850-5
PDIS	Logical node - Distance protection	IEC 61850-5
PDOC	Logical node - AC directional overcurrent protection	IEC 61850-5
PDOV	Logical node - DC overvoltage protection	IEC 61850-5

PDPR	Logical node - Directional power/reverse power protection	IEC 61850-5
PDU	Protocol Data Unit	IEC 61850-7-2
PE	Process Environment	IEC 61850-4
Per	Periodic	IEC 61850-7-4
PF	Power Factor	IEC 61850-7-4
PFRQ	Logical node - Frequency protection	IEC 61850-5
PGDF	Logical node - Generator differential protection	IEC 61850-5
Ph	Phase	IEC 61850-7-4
PHD	PHysical Device	IEC 61850-7-1
PHIZ	Logical node - Earth fault protection/Ground detection	IEC 61850-5
PhPh	Phase to Phase	IEC 61850-7-4
Phy	Physical	IEC 61850-7-4
PICOM	Piece of Information for COMmunication	IEC 61850-1
PICS	Protocol Implementation Conformance Statement (ISO/IEC 8823-2:1994)	IEC 61850-7-2
PIOC	Logical node - Instantaneous overcurrent or rate of rise protection	IEC 61850-5
PITF	Logical node - Interturn fault protection	IEC 61850-5
PIXIT	Protocol Implementation eXtra Information for Testing	IEC 61850-7-2
PLDF	Logical node - Differential line protection	IEC 61850-5
Pls	Pulse	IEC 61850-7-4
Plt	Plate	IEC 61850-7-4
PMDF	Logical node - Motor differential protection	IEC 61850-5
Pmp	Pump	IEC 61850-7-4
PMSU	Logical node - Motor start-up protection	IEC 61850-5
PNDF	Logical node - Restricted earth fault protection	IEC 61850-5
Po	Polar	IEC 61850-7-4
Pol	Polarizing	IEC 61850-7-4
pos	Position	IEC 61850-7-4
POW	Point On Wave Switching	IEC 61850-7-4
PP	Phase to Phase	IEC 61850-7-4
PPAM	Logical node - Phase angle or out-of-step protection	IEC 61850-5
PPBR	Logical node - Reverse phase or phase balance current protection	IEC 61850-5
PPBV	Logical node - Phase sequence or phase-balance voltage protection	IEC 61850-5
PPDF	Logical node - Phase comparison protection	IEC 61850-5
PpdID		IEC 61850-7-1
PPFR	Logical node - Power factor protection	IEC 61850-5
PPV	Phase to Phase Voltage	IEC 61850-7-4
PREF	Logical node - Rotor earth fault protection	IEC 61850-5
Pres	Pressure	IEC 61850-7-4
Prg	Progress	IEC 61850-7-4
Pri	Primary	IEC 61850-7-4
Pro	Protection	IEC 61850-7-4
PROL	Logical node - Rotor thermal overload protection	IEC 61850-5
Ps	Positive	IEC 61850-7-4
PSEF	Logical node - Stator earth fault protection	IEC 61850-5
PSOL	Logical node - Stator thermal overload protection	IEC 61850-5

Pst	Post	IEC 61850-7-4
PTDF	Logical node - Differential transformer protection	IEC 61850-5
PTEF	Logical node - Transient earthfault protection	IEC 61850-5
PTOC	Logical node - AC time overcurrent protection	IEC 61850-5
PTOV	Logical node - (Time) Overvoltage protection	IEC 61850-5
PTTR	Logical node - Thermal overload protection	IEC 61850-5
PTUV	Logical node - (Time) Undervoltage protection	IEC 61850-5
PUCP	Logical node - Undercurrent/underpower protection	IEC 61850-5
PUEX	Logical node - Loss of field/Underexcitation protection	IEC 61850-5
PurgeBuf		IEC 61850-7-1
PVCB	Logical node - Voltage or current balance protection	IEC 61850-5
PVOC	Logical node - Voltage controlled/dependent time overcurrent protection	IEC 61850-5
PVPH	Logical node - Volt per Hz protection	IEC 61850-5
PWDE	Logical node - Directional earth fault protection for compensated networks based on wattmetric principle	IEC 61850-5
Pwr	Power	IEC 61850-7-4
PZSU	Logical node - Zero speed and underspeed protection	IEC 61850-5
qchg	Trigger option for quality-change	IEC 61850-7-2
Qty	Quantity	IEC 61850-7-4
R or Ra	Rais	IEC 61850-7-4
r	readable	IEC 61850-8-1
R0	Zero Sequence Resistance	IEC 61850-7-4
R1	Positive Sequence Resistance	IEC 61850-7-4
Rat	Ratio *	IEC 61850-7-4
Rat	Winding ration (p. 868) *	IEC 61850-7-4
RBRF	Logical node - Breaker failure	IEC 61850-5
RCB	Report Control Block	IEC 61850-6
Rcd	Record or Recording	IEC 61850-7-4
Rch	Reach	IEC 61850-7-4
Rcl	Reclaim	IEC 61850-7-4
RCPW	Logical node - Carrier or pilot wire protection	IEC 61850-5
RDRE	Logical node - Disturbance recording (bay/process level: acquisition)	IEC 61850-5
RDRS	Logical node - Disturbance recording (station level: evaluation)	IEC 61850-5
Re	Retry	IEC 61850-7-4
React	Reactance	IEC 61850-7-4
Rec	Reclose	IEC 61850-7-4
Red	Reduction	IEC 61850-7-4
Rel	Release	IEC 61850-7-4
Rem	Remote	IEC 61850-7-4
Res	Residual	IEC 61850-7-4
Rest	Resistance	IEC 61850-7-4
RFC	Request For Comments	IEC 61850-8-1
RFLO	Logical node - Fault locator	IEC 61850-5
RIF	Routing Information Field (ISO/IEC 8802-5)	IEC 61850-9-2
Ris	Resistance	IEC 61850-7-4
RI	Relation, relative	IEC 61850-7-4
Rms	Root mean square	IEC 61850-7-4

Rot	Rotation, rotor	IEC 61850-7-4
RP	Functional constraint - Unbuffered report	IEC 61850-7-2
RPF	Reverse Power Flow	IEC 61850-7-4
RPSB	Logical node - Power swing blocking	IEC 61850-5
RptEna	Report enable	IEC 61850-7-1
RREC	Logical node - Automatic reclosing	IEC 61850-5
Rs	Reset, Resettable	IEC 61850-7-4
Rsl	Result	IEC 61850-7-4
Rst	Restraint	IEC 61850-7-4
Rsv	Reserve	IEC 61850-7-4
RSYN	Logical node - Synchrocheck/synchronizing or synchronism check	IEC 61850-5
Rte	Rate	IEC 61850-7-4
Rtg	Rating	IEC 61850-7-4
RTU	Remote Terminal Unit	IEC 61850-4
Rv	Reverse	IEC 61850-7-4
Rx	Receive/Received	IEC 61850-7-4
S	Server specified parameter	IEC 61850-8-1
S1	Step one	IEC 61850-7-4
S2	Step two	IEC 61850-7-4
SA	Substation Automation	IEC 61850-1
SAP	Service Access Point	IEC 61850-8-1
SARC	Logical node - Monitoring and diagnostics for arcs	IEC 61850-5
SAS	Substation Automation System	IEC 61850-1
SAT	Site Acceptance Test	IEC 61850-4
SAV	Sampled Analog Value	IEC 61850-9
SBO	Select Before Operate	IEC 61850-9-1
SC	Secondary Converter	IEC 61850-9-1
SCADA	Supervisory Control And Data Acquisition	IEC 61850-3
SCD	Substation Configuration Description	IEC 61850-10
Sch	Scheme	IEC 61850-7-4
SCL	Substation Configuration description Language	IEC 61850-1, IEC 61850 -8-1
SCO	Supply Change Over	IEC 61850-7-4
SCSM	Specific Communication Service Mapping	IEC 61850-1
SDI	Instantiated Sub DATA; middle name part of a structured DATA name	IEC 61850-6
SE	Functional constraint - Setting group editable	IEC 61850-7-2
Sec	Security	IEC 61850-7-3
Seq	Sequence	IEC 61850-7-4
SeqNum	Sequence number	IEC 61850-7-1
Server-CR	Server-Conformance Requirement	IEC 61850-8-1
Set	Setting	IEC 61850-7-4
SF6	Sulphur HexaFluoride gas	IEC 61850-3
SG	Functional constraint - Setting group	IEC 61850-7-2
SGC	Setting Group Control class	IEC 61850-6
SGCB	Setting Group Control Block	IEC 61850-7-2
Sh	Shunt	IEC 61850-7-4
SIG	Status Indication Group	IEC 61850-9-1

SIMS	Logical node - Insulation medium supervision	IEC 61850-5
SmpRate	Sample rate	IEC 61850-7-1
SMV	Sampled Measured Value	IEC 61850-6
SMVC	Sampled Measured Value Control	IEC 61850-7-2
NTP	Network Time Protocol	IEC 61850-8-1
SoE	Sequence of Events	IEC 61850-7-1
Sp	Speed	IEC 61850-7-4
SP	Functional constraint - Setpoint	IEC 61850-7-2
SPC	Single Point Control	IEC 61850-7-4
SPCSO	Single Point Controllable Status Output	IEC 61850-7-4
Spd	Speed	IEC 61850-7-4
SPDC	Logical node - Monitoring and diagnostics for partial discharge	IEC 61850-5
SPI	Single Pole	IEC 61850-7-4
SPS	Single Point Status information	IEC 61850-7-1
Src	Source	IEC 61850-7-4
SSYS	Logical node - System supervision	IEC 61850-5
ST	Functional constraint - Status information	IEC 61850-7-2
St	Status	IEC 61850-7-4
Stat	Statistics	IEC 61850-7-4
Std	Standard	IEC 61850-7-4
STIM	Logical node - Time master	IEC 61850-5
Stop	Stop	IEC 61850-7-4
Str	Start	IEC 61850-7-4
Sts	Stress	IEC 61850-7-4
Sup	Supply	IEC 61850-7-4
SUT	System Under Test	IEC 61850-10
SV	Functional constraint - Sampled Value Substitution	IEC 61850-7-2
Svc	Service	IEC 61850-7-4
SVC	Sampled Value Control	IEC 61850-6
SvEna		IEC 61850-7-1
Sw	Switch	IEC 61850-7-4
Swg	Swing	IEC 61850-7-4
Syn or Sync	Synchronization	IIEC 61850-7-4, IEC 61850-8-1
T	Transient data *	IEC 61850-7-4
T	Transport or Timestamp (p. 983) *	IEC 61850-8-1
TAI	Temps Atomique International	IEC 61850-8-1
Tap	Tap	IEC 61850-7-4
TCI	TeleControl Interface *	IEC 61850-5
TCI	Tag Control Information (p. 1114, 1152) *	IEC 61850-9-2
TCP	Transmission Control Protocol	IEC 61850-3
TCP/IP	Transmission Control Protocol / Internet Protocol	IEC 61850-3
TCTR	Logical node - Current transformer	IEC 61850-5
Td	Total distortion	IEC 61850-7-4
Tdf	Transformer derating factor	IEC 61850-7-4
TE	Telecommunication Environment	IEC 61850-4
Test	Test	IEC 61850-7-4
Thd	Total harmonic distortion	IEC 61850-7-4

Thm	Thermal	IEC 61850-7-4
Tif	Telephone influence factor	IEC 61850-7-4
Tm	Time	IEC 61850-7-4
Tmh	Time in hours	IEC 61850-7-4
TMI	TeleMonitoring Interface (for example to engineer's workstation)	IEC 61850-5
Tmm	Time in minutes	IEC 61850-7-4
Tmms	Time in milliseconds	IEC 61850-7-4
Tmp	Temperature	IEC 61850-7-4
Tms	Time in seconds	IEC 61850-7-4
To	Top	IEC 61850-7-4
Tot	Total	IEC 61850-7-4
TP	Three Pole *	IEC 61850-7-4
TP	Two-party (p. 621) *	IEC 61850-7-3, IEC 61850-7-2
TPAA	Two Party Application Association	IEC 61850-7-2
TPID	Tag Protocol Identifier *	IEC 61850-9-2
TPID	Priority Tagging Identification (for IEEE 802.1Q networks) = 0x8100 (p. 983) *	IEC 61850-8-1
T-Profile	Transport Profile	IEC 61850-8-1
Tr	Trip	IEC 61850-7-4
Trg	Trigger	IEC 61850-7-4
TrgOp	Trigger Option	IEC 61850-7-2
TrgOpEna	Trigger Option Enabled	IEC 61850-7-2
TrgOps	Trigger options	IEC 61850-7-1
Ts	Total signed	IEC 61850-7-4
Tu	Total unsigned	IEC 61850-7-4
TVTR	Logical node - Voltage transformer	IEC 61850-5
Tx	Transmit/Transmitted	IEC 61850-7-4
Typ	Type	IEC 61850-7-4
U or u	User-specific: Indicates that the service, parameter, or attribute can be defined by an implementation	IEC 61850-8-1
U= or u=	User-specific information that shall be equal the original information supplied in the request	IEC 61850-8-1
UCA™	Utility Communications Architecture	IEC 61850-7-2
UML	Unified Modelling Language	IEC 61850-7-1
Un	Under	IEC 61850-7-4
UNICODE STRING	Max. length defined where type is used	IEC 61850-7-3
URC	Unbuffered Report Control	IEC 61850-7-2
URCB	Unbuffered Report Control Block	IEC 61850-7-2
URI	Universal Resource Identifier	IEC 61850-6
US	Functional constraint - Unicast sampled value control	IEC 61850-7-2
USMVC	Unicast Sampled Measured Value Control	IEC 61850-7-2
USV	Unicast Sampled Value	IEC 61850-6
USVC	Unicast Sampled Value Control	IEC 61850-7-2
USVCB	Unicast Sampled Value Control Block	IEC 61850-7-2
UsvID	ID for USV (Unicast Sampled Value)	IEC 61850-6
UTC	Co-ordinated Universal Time	IEC 61850-7-2
V	Voltage	IEC 61850-7-4

VA	Volt Amperes	IEC 61850-7-4
Vac	Vacuum	IEC 61850-7-4
Val	Value	IEC 61850-7-4
Var	Volt Amperes reactive	IEC 61850-7-4
VARSPEC	Variable Specification	IEC 61850-8-1
V-Get	Virtual Get function (ISO 9506-1)	IEC 61850-8-1
VID	VLAN IDentifier	IEC 61850-9-2
VISIBLE STRING	Max. length defined where type is used	IEC 61850-7-3, IEC 61850-7-2
VLAN	Virtual Local Area Network	IEC 61850-9-2
Vlv	Valve	IEC 61850-7-4
VMD	Virtual Manufacturing Device	IEC 61850-8-1
Vol	Voltage (non-phase related)	IEC 61850-7-4
V-Put	Virtual Put function (ISO 9506-1)	IEC 61850-8-1
VT	Voltage Transformer/Transducer	IEC 61850-4
W	Watts active power	IEC 61850-7-4
w	writeable	IEC 61850-8-1
Wac	Watchdog	IEC 61850-7-4
Watt	Active power (non-phase related)	IEC 61850-7-4
Wei	Week end infeed	IEC 61850-7-4
Wh	Watt hours	IEC 61850-7-4
Wid	Width	IEC 61850-7-4
Win	Window	IEC 61850-7-4
Wrm	Warm	IEC 61850-7-4
X	Excluded: The user shall not implement this item	IEC 61850-9-2
X0	Zero sequence reactance	IEC 61850-7-4
X1	Positive sequence reactance	IEC 61850-7-4
XCBR	Logical node - The LN 'circuit breaker' covers all kinds of circuit breakers, i.e. switches able to interrupt short circuits	IEC 61850-5
XML	eXtensible Mark-up Language	IEC 61850-1
XSWI	Logical node - The LN 'switch' covers all kinds of switching devices not able to switch short circuits	IEC 61850-5
XX	Functional constraint - Wildcard representing all Data Attributes as a service parameter	IEC 61850-7-2
YEFN	Logical node - Earth fault neutralizer (Petersen coil)	IEC 61850-5
YLTC	Logical node - Tap changer	IEC 61850-5
YPSH	Logical node - Power shunt	IEC 61850-5
YPTR	Logical node - Power transformer	IEC 61850-5
Z	impedance	IEC 61850-7-4
Z0	Zero sequence impedance	IEC 61850-7-4
Z1	Positive sequence impedance	IEC 61850-7-4
ZAXN	Logical node - Auxiliary network	IEC 61850-5
ZBAT	Logical node - Battery	IEC 61850-5
ZBSH	Logical node - Bushing	IEC 61850-5
ZCAB	Logical node - Power cable	IEC 61850-5
ZCAP	Logical node - Capacitor bank	IEC 61850-5
ZCON	Logical node - Converter	IEC 61850-5
Zer	Zero	IEC 61850-7-4
ZGEN	Logical node - Generator	IEC 61850-5

ZGIL	Logical node - Gas isolated Line (GIL)	IEC 61850-5
ZLIN	Logical node - Power overhead line	IEC 61850-5
ZMOT	Logical node - Motor	IEC 61850-5
Zn	Zone	IEC 61850-7-4
ZREA	Logical node - Reactor	IEC 61850-5
Zro	Zero sequence method	IEC 61850-7-4
ZRRC	Logical node - Rotating reactive component	IEC 61850-5
ZSAR	Logical node - Surge arrester	IEC 61850-5
ZTCF	Logical node - Thyristor controlled frequency converter	IEC 61850-5
ZTCR	Logical node - Thyristor controlled reactive component	IEC 61850-5

7 Support, Service & Warranty

7.1 Contacting Technical Support

ProSoft Technology, Inc. is committed to providing the most efficient and effective support possible. Before calling, please gather the following information to assist in expediting this process:

- 1 Product Version Number
- 2 System architecture
- 3 Network details

If the issue is hardware related, we will also need information regarding:

- 1 Module configuration and associated ladder files, if any
- 2 Module operation and any unusual behavior
- 3 Configuration/Debug status information
- 4 LED patterns
- 5 Details about the serial, Ethernet or Fieldbus devices interfaced to the module, if any.

Note: For technical support calls within the United States, ProSoft Technology's 24/7 after-hours phone support is available for urgent plant-down issues.

North America (Corporate Location) Phone: +1.661.716.5100 info@prosoft-technology.com Languages spoken: English, Spanish REGIONAL TECH SUPPORT support@prosoft-technology.com	Europe / Middle East / Africa Regional Office Phone: +33.(0)5.34.36.87.20 france@prosoft-technology.com Languages spoken: French, English REGIONAL TECH SUPPORT support.emea@prosoft-technology.com
Latin America Regional Office Phone: +52.222.264.1814 latinam@prosoft-technology.com Languages spoken: Spanish, English REGIONAL TECH SUPPORT support.la@prosoft-technology.com	Asia Pacific Regional Office Phone: +60.3.2247.1898 asiapc@prosoft-technology.com Languages spoken: Bahasa, Chinese, English, Japanese, Korean REGIONAL TECH SUPPORT support.ap@prosoft-technology.com

For additional ProSoft Technology contacts in your area, please visit:

www.prosoft-technology.com/About-Us/Contact-Us

7.2 Warranty Information

For complete details regarding ProSoft Technology's TERMS & CONDITIONS OF SALE, WARRANTY, SUPPORT, SERVICE AND RETURN MATERIAL AUTHORIZATION INSTRUCTIONS, please see the documents at:

www.prosoft-technology.com/legal