



MVI69E-GSC

CompactLogix™ or MicroLogix™
Platform

Generic ASCII Serial Communication
Module

December 12, 2022

Your Feedback Please

We always want you to feel that you made the right decision to use our products. If you have suggestions, comments, compliments or complaints about our products, documentation, or support, please write or call us.

ProSoft Technology, Inc.

+1 (661) 716-5100
+1 (661) 716-5101 (Fax)
www.prosoft-technology.com
support@prosoft-technology.com

MVI69E-GSC User Manual
For Public Use.

December 12, 2022

ProSoft Technology®, is a registered copyright of ProSoft Technology, Inc. All other brand or product names are or may be trademarks of, and are used to identify products and services of, their respective owners.

In an effort to conserve paper, ProSoft Technology no longer includes printed manuals with our product shipments. User Manuals, Datasheets, Sample Ladder Files, and Configuration Files are provided at our website: www.prosoft-technology.com

Content Disclaimer

This documentation is not intended as a substitute for and is not to be used for determining suitability or reliability of these products for specific user applications. It is the duty of any such user or integrator to perform the appropriate and complete risk analysis, evaluation and testing of the products with respect to the relevant specific application or use thereof. Neither ProSoft Technology nor any of its affiliates or subsidiaries shall be responsible or liable for misuse of the information contained herein. Information in this document including illustrations, specifications and dimensions may contain technical inaccuracies or typographical errors. ProSoft Technology makes no warranty or representation as to its accuracy and assumes no liability for and reserves the right to correct such inaccuracies or errors at any time without notice. If you have any suggestions for improvements or amendments or have found errors in this publication, please notify us.

No part of this document may be reproduced in any form or by any means, electronic or mechanical, including photocopying, without express written permission of ProSoft Technology. All pertinent state, regional, and local safety regulations must be observed when installing and using this product. For reasons of safety and to help ensure compliance with documented system data, only the manufacturer should perform repairs to components. When devices are used for applications with technical safety requirements, the relevant instructions must be followed. Failure to use ProSoft Technology software or approved software with our hardware products may result in injury, harm, or improper operating results. Failure to observe this information can result in injury or equipment damage.

© 2022 ProSoft Technology. All Rights Reserved.

Printed documentation is available for purchase. Contact ProSoft Technology for pricing and availability.



For professional users in the European Union

If you wish to discard electrical and electronic equipment (EEE), please contact your dealer or supplier for further information.



Warning – Cancer and Reproductive Harm – www.P65Warnings.ca.gov

Important Safety Information

North America Warnings

- A** This Equipment is Suitable For Use in Class I, Division 2, Groups A, B, C, D or Non-Hazardous Locations Only.
- B** Warning – Explosion Hazard – Substitution of Any Components May Impair Suitability for Class I, Division 2.
- C** Warning – Explosion Hazard – Do Not Disconnect Equipment Unless Power Has Been Switched Off Or The Area is Known To Be Non-Hazardous.
- D** The subject devices are powered by a Switch Model Power Supply (SMPS) that has regulated output voltage of 5 VDC.

ATEX/IECEx Warnings and Conditions of Safe Usage:

Power, Input, and Output (I/O) wiring must be in accordance with the authority having jurisdiction.

- A** Warning - Explosion Hazard - When in hazardous locations, turn off power before replacing or wiring modules.
- B** Warning - Explosion Hazard - Do not disconnect equipment unless power has been switched off or the area is known to be non-hazardous.
- C** These products are intended to be mounted in an ATEX/IECEx Certified, tool-secured, IP54 enclosure. The devices shall provide external means to prevent the rated voltage being exceeded by transient disturbances of more than 40%. This device must be used only with ATEX certified backplanes.
- D** Before operating the reset switch, be sure the area is known to be non-hazardous.

If the equipment is used in a manner not specified by the manufacturer, the protection provided by the equipment may be impaired.

Agency Approvals & Certifications

Please visit our website: www.prosoft-technology.com

Contents

Your Feedback Please	2
Content Disclaimer	2
Important Safety Information	3
1 Start Here	6
1.1 System Requirements	6
1.2 Package Contents	7
1.3 Setting Jumpers	7
1.4 Install the Module in the Rack	9
2 Configuring the Module in RSLogix	12
2.1 Creating the Module in an Studio 5000 Project	12
2.2 Importing the Add-On Instruction	15
2.2.1 Importing the Add-On Instruction	15
2.2.2 Adding Multiple Modules in the Rack (Optional)	18
2.3 Downloading the Sample Program to the Processor	22
3 Optional AOI	23
3.1 Importing the Optional AOI	23
3.2 Setting up the Optional AOI	25
3.3 Synchronizing the IP Settings from the MVI69E-GSC to the Processor	27
3.4 Synchronizing the IP Settings from the Processor to the MVI69E-GSC	28
3.5 Reading the Date/Time from the MVI69E-GSC to the Processor	29
3.6 Writing the Date/Time from the Processor to the MVI69E-GSC	30
4 Using ProSoft Configuration Builder	31
4.1 Installing ProSoft Configuration Builder Software	31
4.2 Setting Up the Project	31
4.2.1 Adding the MVI69E-GSC module to the project	32
4.3 Renaming PCB Objects	33
4.4 Module Configuration Parameters	34
4.4.1 Module Parameters	34
4.4.2 GSC Port x Parameters	35
4.4.3 MVI69E-GSC IP Address Configuration	37
4.5 Downloading the Configuration File to the Module	38
4.6 Uploading the Configuration File from the Module	40
4.7 Converting a Legacy MVI69-GSC to an MVI69E-GSC	42
5 Using Controller Tags	43
5.1 MVI69E-GSC Controller Tags	44
5.2 User-Defined Data Types (UDTs)	45
5.2.1 MVI69E-GSC User-Defined Data Types	45
5.3 GSC Controller Tag Overview	46
5.3.1 GSC.DATA	46

5.3.2	GSC.STATUS	47
5.3.3	GSC.CONTROL.....	47
6	Transmitting ASCII Data	48
6.1	Sending ASCII Strings from the Processor to a Serial Device	48
6.2	Receiving ASCII Strings from a Serial Device to the Processor	49
7	Diagnostics and Troubleshooting	50
7.1	LED Status Indicators	50
7.2	Ethernet LED Indicators.....	51
7.3	Clearing a Fault Condition	51
7.4	Troubleshooting	52
7.5	Configuring a Temporary IP Address	53
7.6	Diagnostics Menu	55
7.6.1	Diagnostics Menu Navigation	57
7.6.2	Monitoring Network Configuration Information	57
7.6.3	Monitoring Backplane Information	58
7.6.4	Port x Module Information.....	59
7.6.5	Data Analyzer	60
7.7	Connecting to the Module's Webpage.....	63
8	Reference	64
8.1	Product Specifications	64
8.1.1	Hardware Specifications	64
8.1.2	Functional Specifications	65
8.2	Functional Overview	66
8.2.1	General Concepts.....	66
8.2.2	Backplane Data Flow.....	66
8.2.3	Special Function Blocks.....	70
8.3	Ethernet Port Connection	71
8.3.1	Ethernet Cable Specifications.....	71
8.4	Application Port Cable Connection	72
8.4.1	RS-232 Wiring.....	72
8.4.2	RS-422 Wiring.....	75
8.4.3	RS-485 Wiring.....	75
8.4.4	DB9 to RJ45 Adaptor (Cable 14)	76
8.5	Status Data Definition	77
9	Support, Service & Warranty	80
9.1	Contacting Technical Support.....	80
9.2	Warranty Information	80

1 Start Here

To get the most benefit from this User Manual, you know the following skills:

- **Studio 5000 Logix Designer®:** launch the program, configure ladder logic, and transfer the ladder logic to the processor
- **Microsoft Windows:** install and launch programs, execute menu commands, navigate dialog boxes, and enter data
- **Hardware installation and wiring:** install the module, and safely connect and CompactLogix or MicroLogix devices to a power source and to the MVI69E-GSC module's application port(s)

1.1 System Requirements

The MVI69E-GSC module requires the following minimum hardware and software components:

- Rockwell Automation CompactLogix or MicroLogix 1500-LRP® processor (firmware version 10 or higher), with compatible power supply and one free slot in the rack, for the MVI69E-GSC module.

Important: The MVI69E-GSC module has a power supply distance rating of 4 (L43 and L45 installations on first 2 slots of 1769 bus). It consumes 500 mA at 5 VDC.

Important: For 1769-L23x processors, please make note of the following limitation:
1769-L23E-QBFC1B = 450 mA at 5 VDC (No MVI69E module can be used with this processor.)

- The module requires 500 mA of available 5 VDC power
- Rockwell Automation Studio 5000 Logix Designer version 16 or higher
- Rockwell Automation RSLinx® communication software version 2.51 or higher
- ProSoft Configuration Builder (PCB) (included)
- ProSoft Discovery Service (PDS) (included in PCB)
- Pentium® II 450 MHz minimum. Pentium III 733 MHz (or better) recommended
- Supported operating systems:
 - Microsoft Windows 10
 - Microsoft Windows 7 Professional (32-or 64-bit)
 - Microsoft Windows XP Professional with Service Pack 1 or 2
 - Microsoft Windows Vista
 - Microsoft Windows 2000 Professional with Service Pack 1, 2, or 3
 - Microsoft Windows Server 2003
- 128 Mbytes of RAM minimum, 256 Mbytes of RAM recommended
- 100 Mbytes of free hard disk space (or more based on application requirements)
- 256-color VGA graphics adapter, 800 x 600 minimum resolution

Note: The Hardware and Operating System requirements in this list are the minimum recommended to install and run software provided by ProSoft Technology®. Other third party applications may have different minimum requirements.

1.2 Package Contents

The following components are included with your MVI69E-GSC module, and are all required for installation and configuration.

Important: Before beginning the installation, please verify that all of the following items are present.

Qty.	Part Name	Part Number	Part Description
1	MVI69E-GSC Module	MVI69E-GSC	Generic ASCII Serial Communication Module
2	Adapter Cable	Cable #14	RJ45 to DB9 Male Adapter cable. For DB9 connection to module's serial application ports
2	Screw Terminal Adapter	1454-9F	DB9 female to 9-pin screw terminal. Used for RS422 or RS485 connections to Port 1 and 2 of the module

If any of these components are missing, please contact ProSoft Technology Support for replacement parts.

1.3 Setting Jumpers

When the module is manufactured, the port selection jumpers are set to RS-232. To use RS-422 or RS-485, you must set the jumpers to the correct position. The following diagram describes the jumper settings.

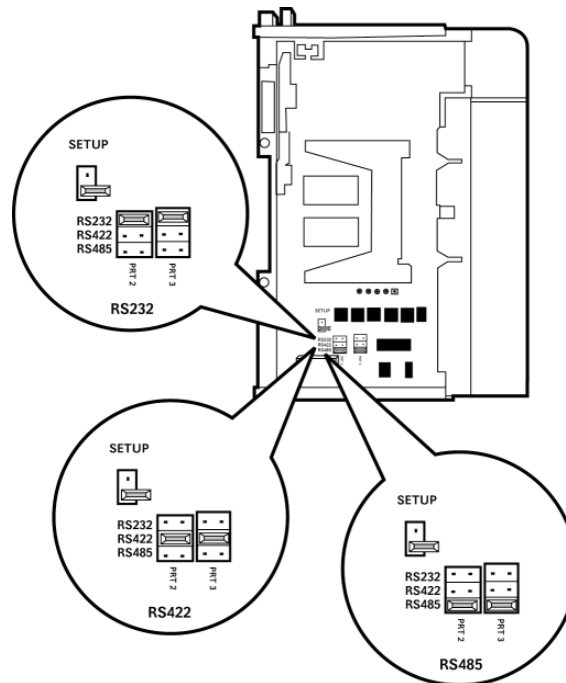

Note: Jumper pin placement on the circuit board may vary.

The Setup Jumper acts as "write protection" for the module's firmware. In "write protected" mode, the Setup pins are not connected, and the module's firmware cannot be overwritten. The module is shipped with the Setup jumper OFF. If an update of the firmware is needed, apply the Setup jumper to both pins.

The following illustration shows the MVI69E-GSC jumper configuration, with the Setup Jumper OFF.

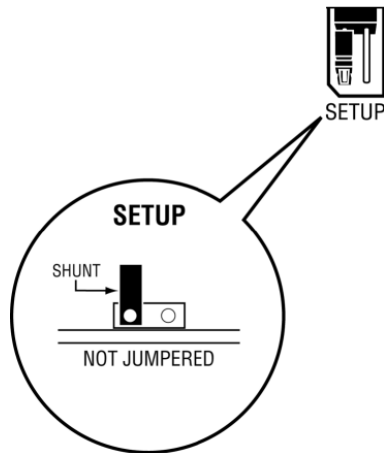

1.4 Install the Module in the Rack

Make sure the processor and power supply are installed and configured before installing the MVI69E-GSC module. Refer to the Rockwell Automation product documentation for installation instructions.

Warning: Please follow all safety instructions when installing this or any other electronic devices. Failure to follow safety procedures could result in damage to hardware or data, or even serious injury or death to personnel. Refer to the documentation for each device to be connected to verify that suitable safety procedures are in place before installing or servicing the device.

After you verify the jumper placements, insert the MVI69E-GSC into the rack. Use the same technique recommended by Rockwell Automation to remove and install CompactLogix or MicroLogix 1500-LRP modules.

Warning: This module is not hot-swappable! Always remove power from the rack before inserting or removing this module, or damage may result to the module, the processor, or other connected devices.

- 1 Align the module using the upper and lower tongue-and-groove slots with the adjacent module and slide forward in the direction of the arrow.

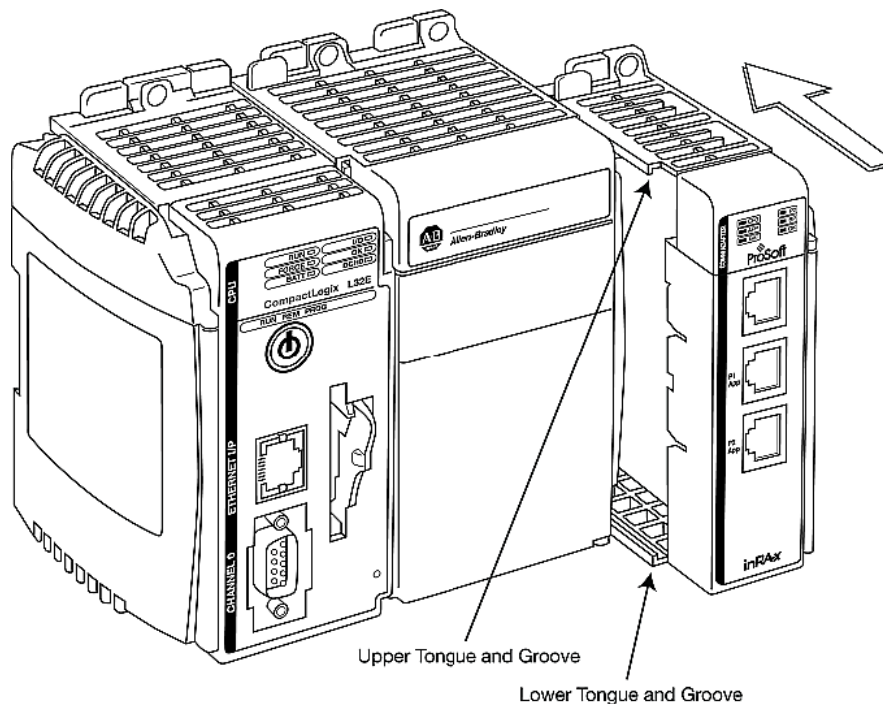

- 2 Move the module back along the tongue-and-groove slots until the bus connectors on the module and the adjacent module line up with each other.

- 3 Push the module's bus lever back slightly to clear the positioning tab and move it firmly to the left until it clicks. Ensure that it is locked firmly in place.

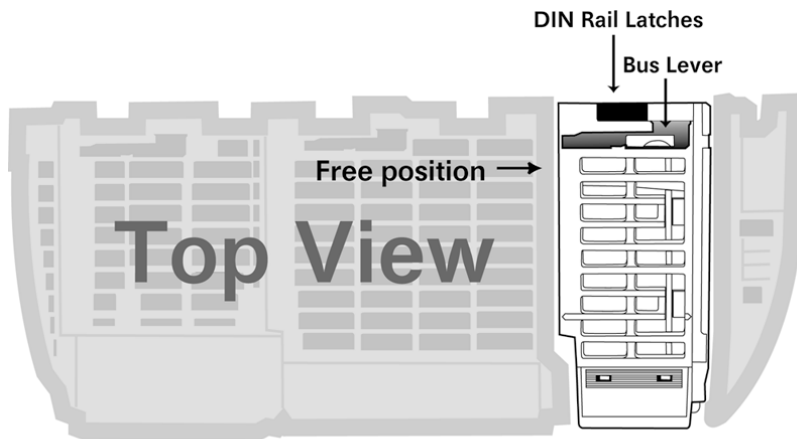

Move the Bus Lever to the left until it clicks

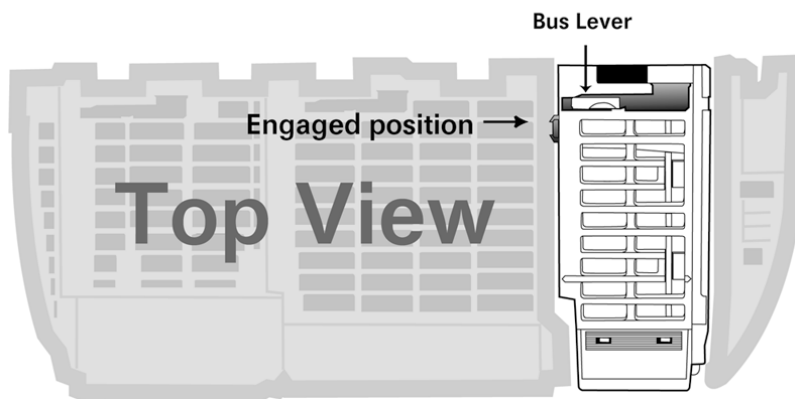

- 4 Close all DIN-rail latches.

- 5 Press the DIN-rail mounting area of the controller against the DIN-rail. The latches will momentarily open and lock into place.

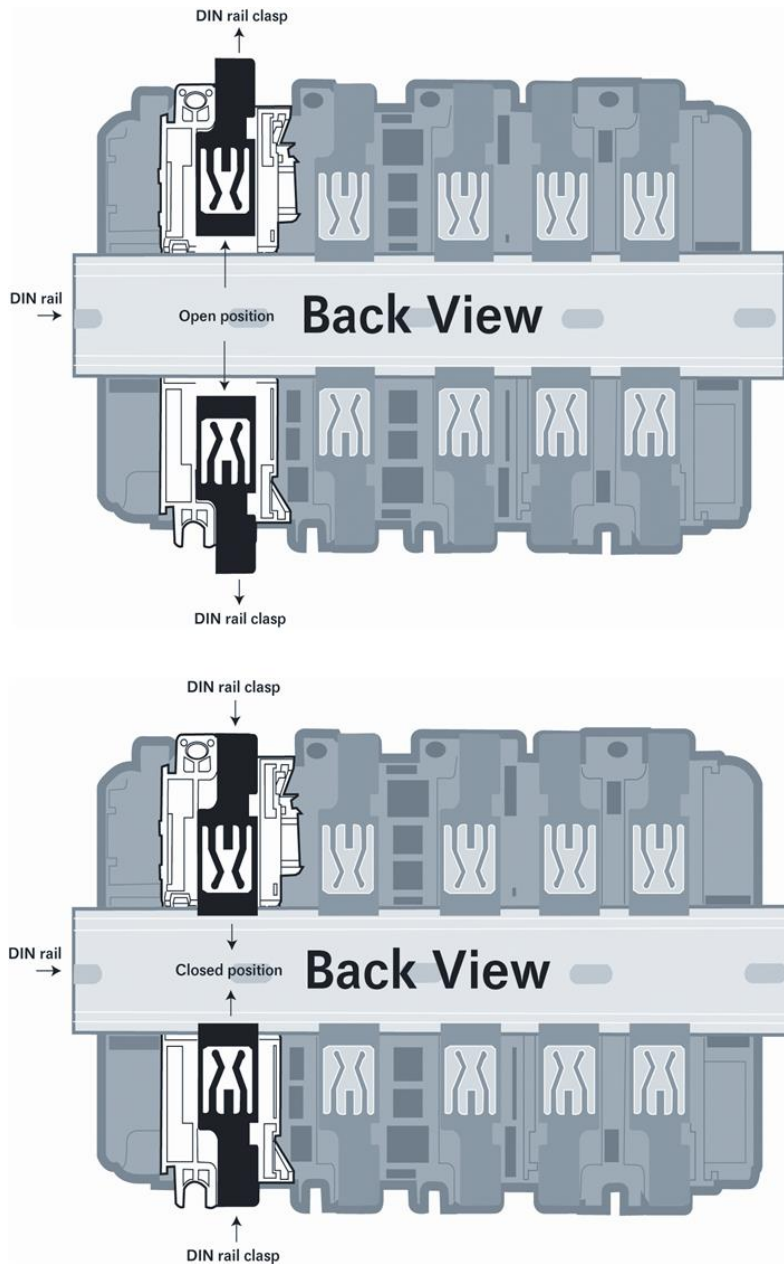

2 Configuring the Module in RSLogix

To add the MVI69E-GSC module in Studio 5000, you must:

- 1 Create a new project in Studio 5000.
- 2 Add the module to the Studio 5000 project.
 - You can manually create the module using a generic 1769 profile, and then manually configure the module parameters.
- 3 Download the *MVI69EGSC_AddOn_Rung.L5X* file from www.prosoft-technology.com.
- 4 Import the Add-On Instruction (the .L5X file) into Studio 5000.

The .L5X file contains the Add-On Instruction, user-defined data types, controller tags and ladder logic required to configure the MVI69E-GSC module.

2.1 Creating the Module in an Studio 5000 Project

In a Studio 5000 project, you can manually create and configure the module using a generic 1769 profile.

- 1 Expand the **I/O CONFIGURATION** folder in the Project tree. Right-click the appropriate communications bus and choose **NEW MODULE**.

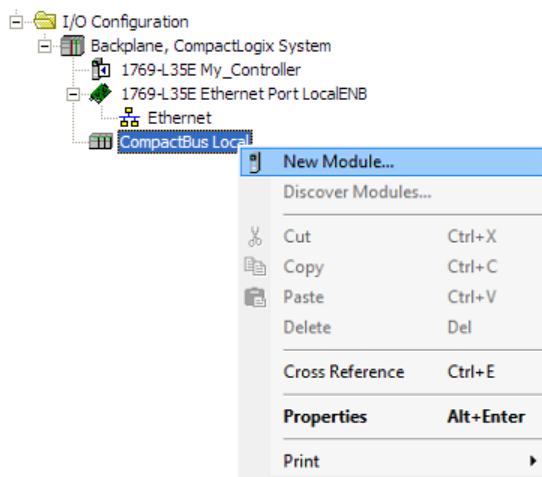

This opens the *Select Module Type* dialog box.

- 2 In the *Select Module Type* dialog, select the **1769-MODULE** and click on the **CREATE** button.

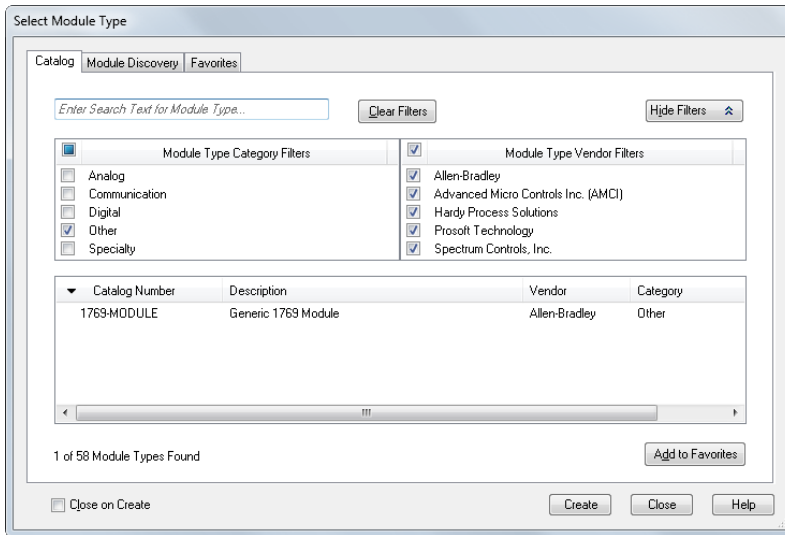

- 3 Set the *Module Properties* values as follows:

Parameter	Value
Name	Enter a module identification string. Example: MVI69EGSC
Description	Enter a description for the module. Example: ProSoft communication module for Serial Modbus communications.
Comm Format	Select DATA-INT
Slot	Enter the slot number in the rack where the MV69E-GSC module is installed.
Input Assembly Instance	101
Input Size	60
Output Assembly Instance	100
Output Size	60
Configuration Assembly Instance	102
Configuration Size	0

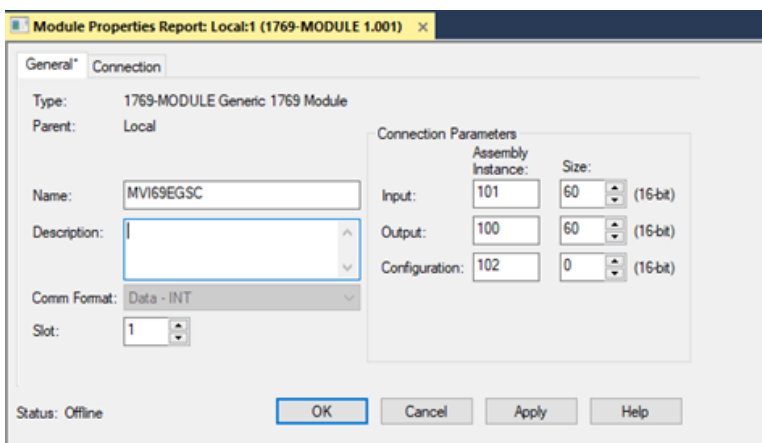

- 4 On the *Connection* tab, set the **REQUESTED PACKET INTERVAL** value for your project and click **OK**. A value of **10.0** ms or more is recommended.

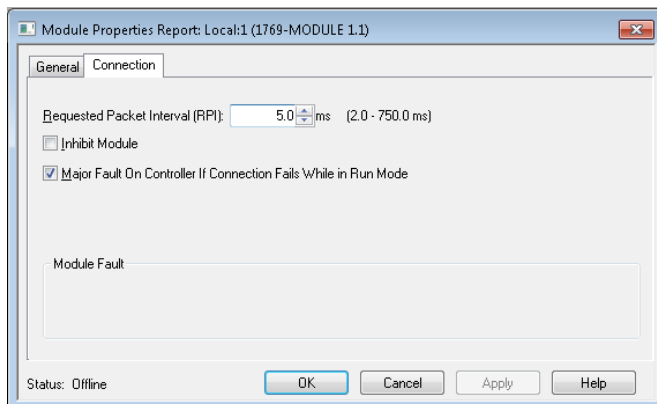

The MVI69E-GSC module is now visible in the *I/O Configuration* tree.

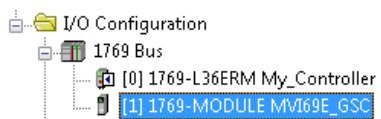

2.2 Importing the Add-On Instruction

Note: This section only applies if you are using Studio 5000 version 16 or higher. If you are configuring the MVI69E-GSC module with an earlier version of Studio 5000, please refer to Adding the Module to an Existing CompactLogix Project (page 22).

The following file is required before you start this procedure. You can download it from www.prosoft-technology.com.

File Name	Description
MVI69EGSC_AddOn_Rung.L5X	File containing Add-On instruction, user defined data types, data objects and ladder logic required to set up the MVI69E-GSC module

2.2.1 Importing the Add-On Instruction

- 1 In RSLogix, expand the *Tasks > Main Task > Main Program* folder.
- 2 Double-click on the *MainRoutine* icon.
- 3 In an empty rung, right-click the mouse button to open a shortcut menu.
- 4 On the shortcut menu, choose **IMPORT RUNGS...**

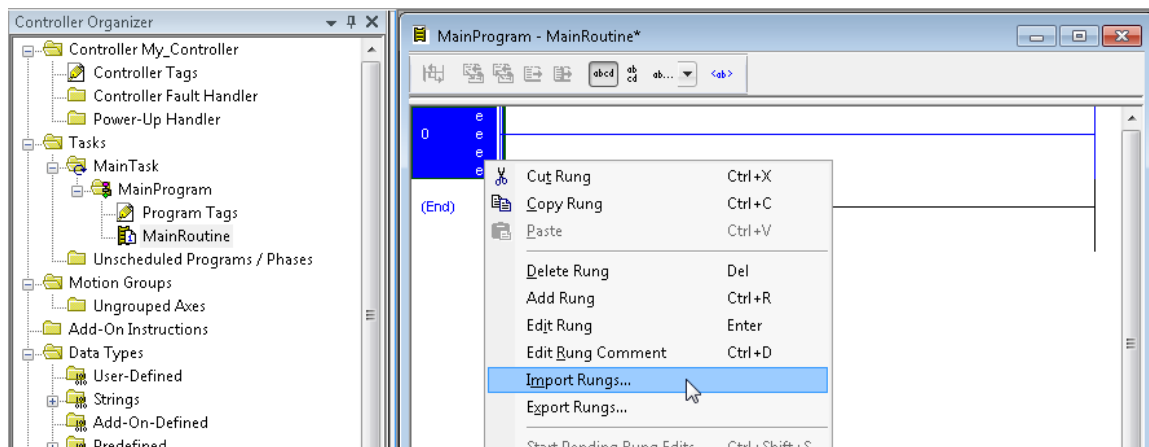

- Select the *MVI69EGSC_AddOn_Rung_v1_x.L5X* file. The Add-On Instruction file is located at www.prosoft-technology.com. Click on the **IMPORT** button.

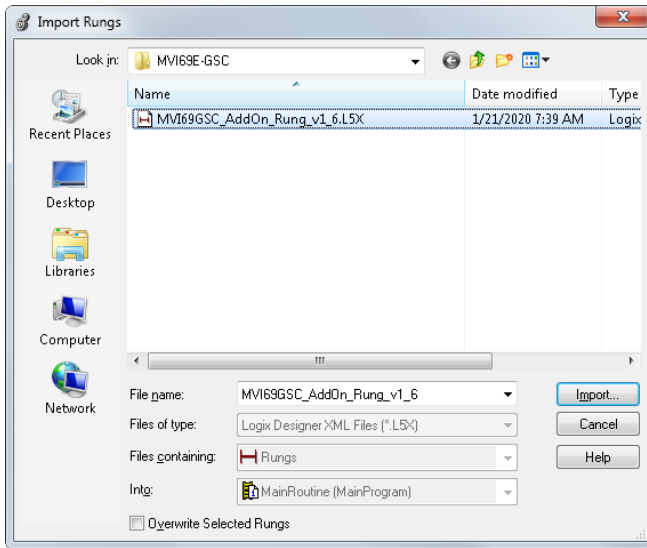

- The following window displays the controller tags to be created during the import procedure. Make sure the slot number reference (Local:x) is correct.

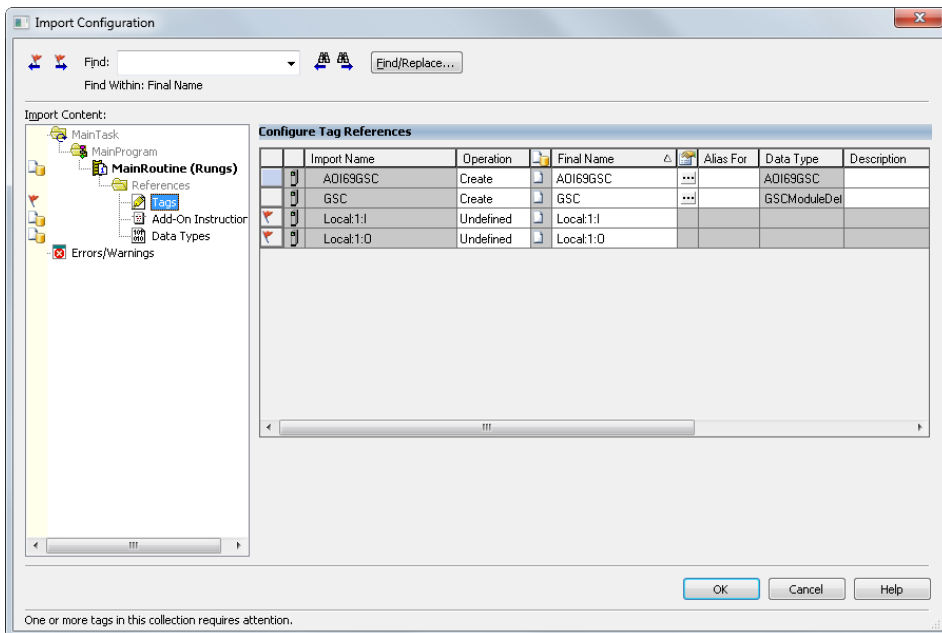

- When the import is complete, the new rung with the Add-On instruction is visible as shown in the following illustration.

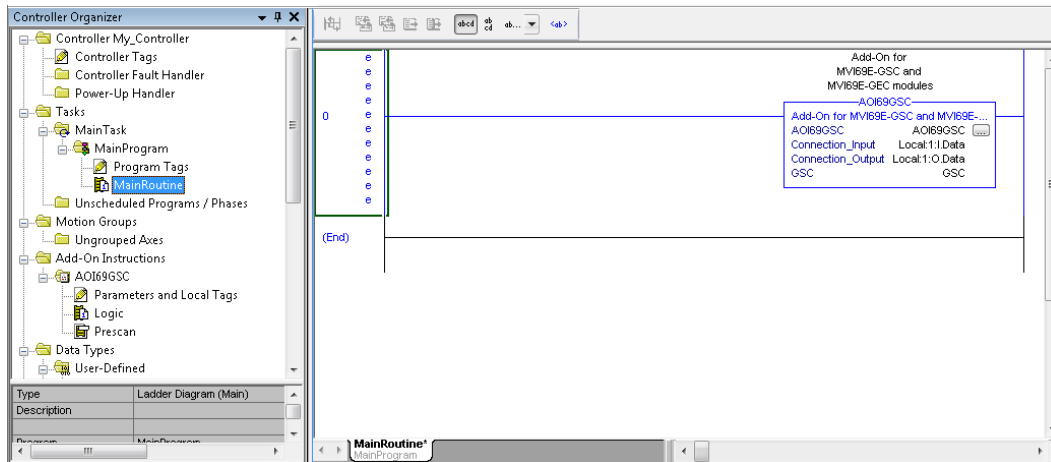

The procedure imports new user defined data types, data objects and the Add-On instruction.



- Save and download the project into the processor.

2.2.2 Adding Multiple Modules in the Rack (Optional)

Important: If your application requires more than one MVI69E-GSC module in the same project, follow the steps below.

- 1 In the *I/O Configuration* folder, right-click the mouse button to open a shortcut menu, and then select **NEW MODULE**.

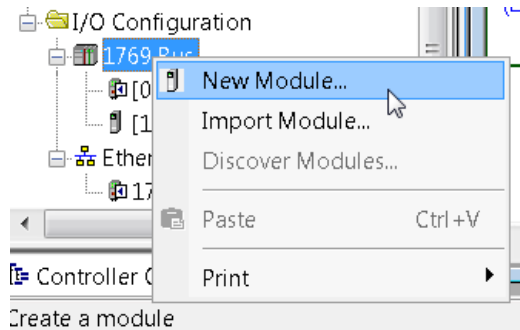

- 2 Under the *Module Type Vendor Filters* section, select **ProSoft Technology**. Then select the **MVI69** option and click the **CREATE** button.

Note: You can also add the module as a 'Generic 1769 module', as described in *Creating the Module in an Studio 5000 Project* on page 12.

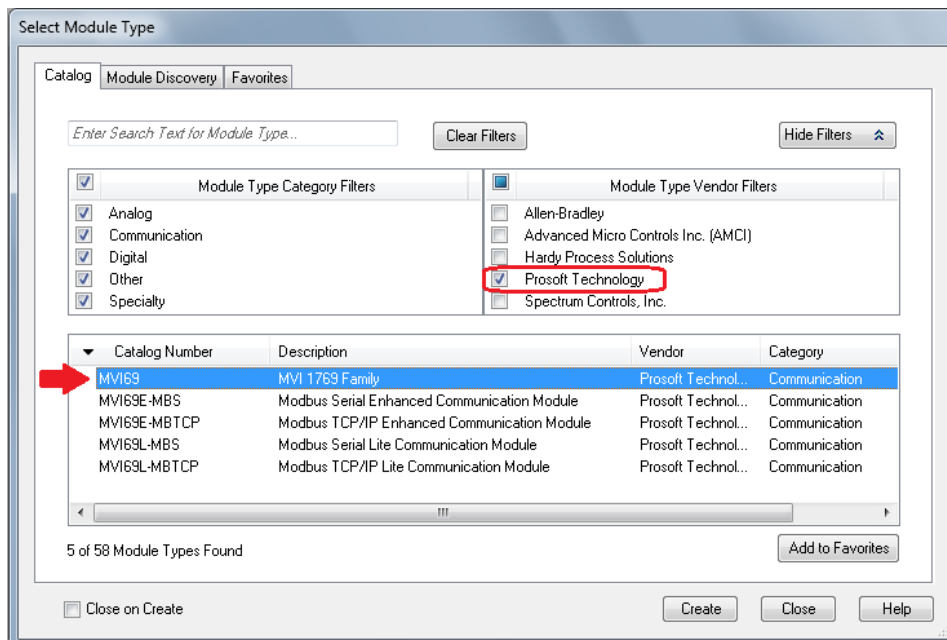

- 3 In the *New Module* dialog, enter the *Name*, *Description*, and *Slot* options for your application, then click on the *Connection* tab.

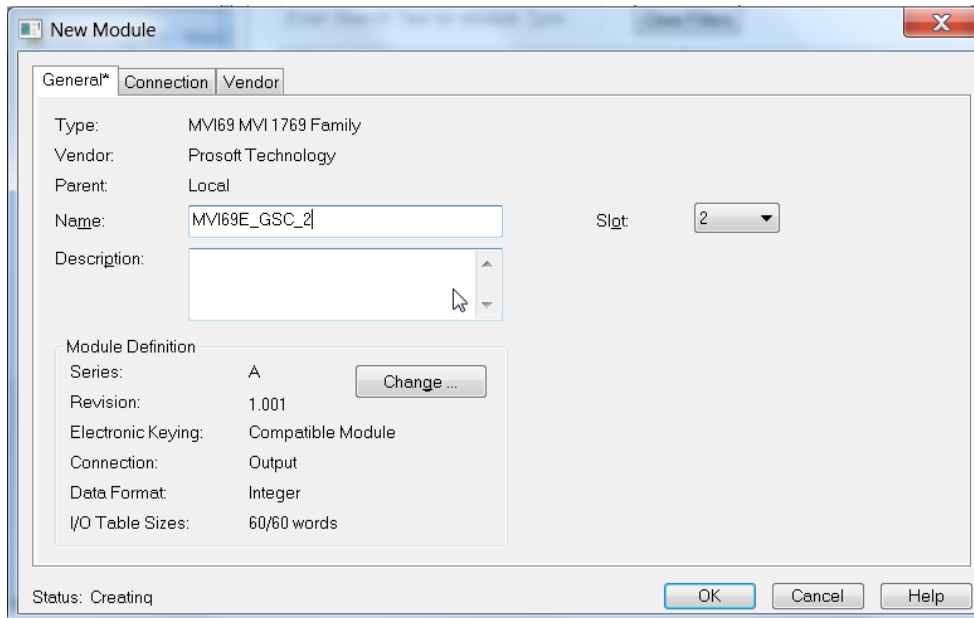

- 4 Select the *Request Packet Interval* value for scanning the I/O on the module. This value represents the minimum frequency the module will handle scheduled events. This value should not be set to less than 2 millisecond. Values between 2 and 10 milliseconds should work with most applications.

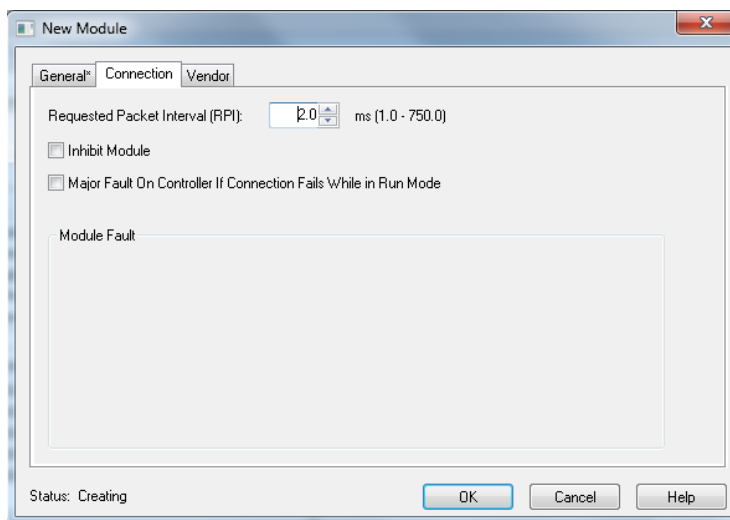

5 Click **OK** to confirm. The new module is now visible in the *I/O Configuration*:

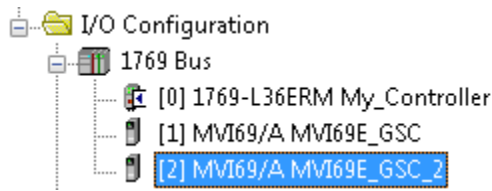

- 6 Expand the *Tasks* folder, and then expand the *MainTask* folder.
- 7 On the *MainProgram* folder, right-click the mouse button to open a shortcut menu. On the shortcut menu, choose **NEW ROUTINE**.
- 8 In the *New Routine* dialog box, enter the name and description of your routine, and then click **OK**.
- 9 Select an empty rung in the new routine, and then right-click the mouse button to open a shortcut menu. On the shortcut menu, choose **IMPORT RUNG...**

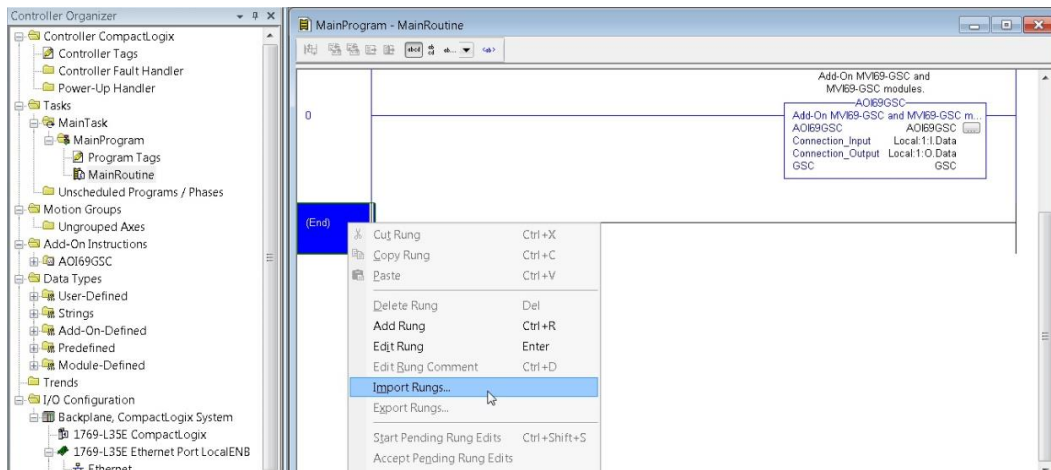

10 Select the *MVI69EGSC_AddOn_Rung.L5X* file, and click **IMPORT**.

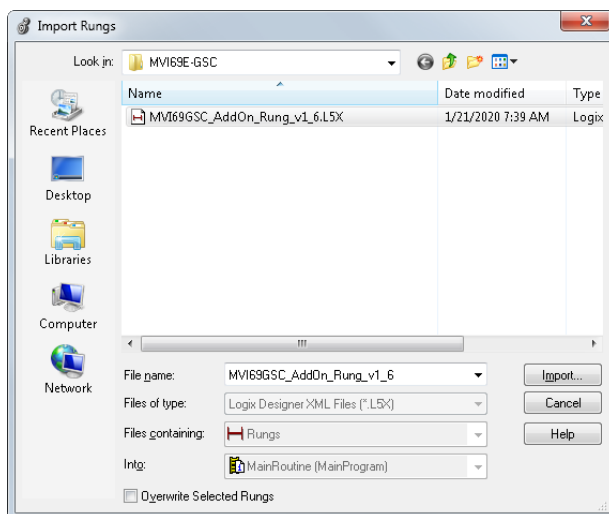

- 11 This opens the **IMPORT CONFIGURATION** dialog box. Click the **TAGS** tab to show the controller tags in the AOI. You must edit the **FINAL NAME** column of the tags for the second module to make them unique.
- 12 Associate the I/O connection variables to the correct module in the corresponding slot number. The default values are Local:1:I and Local:1:O. You must edit these values if the card is placed in a slot location other than slot 1 (Local:1:x means the card is located in slot 1). Since the second card is placed in slot 2, change the **FINAL NAME** to Local:2:I and Local:2:O. Also, you can append a ‘_2’ at the end of the **FINAL NAME** of ‘AOI69_GSC’ and ‘GSC’ arrays as shown below.

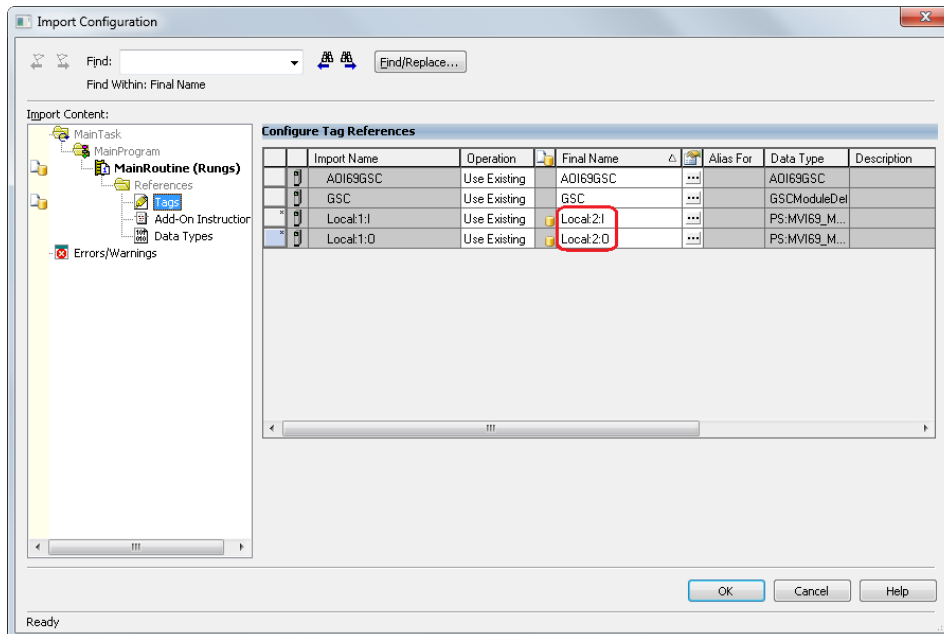

- 13 Click **OK** to confirm.

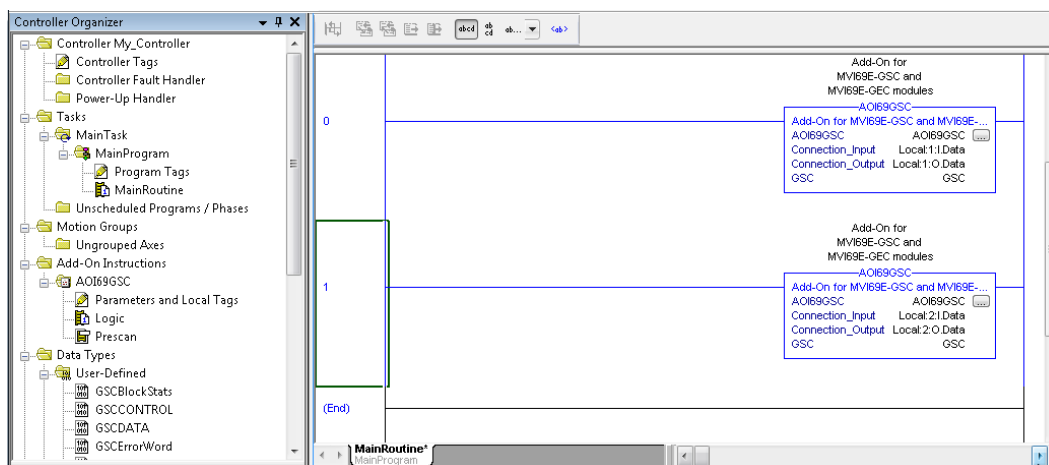

- 14 The setup procedure is now complete. Save and download the project to the processor.

2.3 Downloading the Sample Program to the Processor

Note: The key switch on the front of the *CompactLogix* processor must be in the REM or PROG position.

- 1 If you are not already online to the processor, open the **COMMUNICATIONS** menu, and then choose **DOWNLOAD**. *RSLogix* will establish communication with the processor.
- 2 When communication is established, *RSLogix* will open a confirmation dialog box. Click the **DOWNLOAD** button to transfer the sample program to the processor.

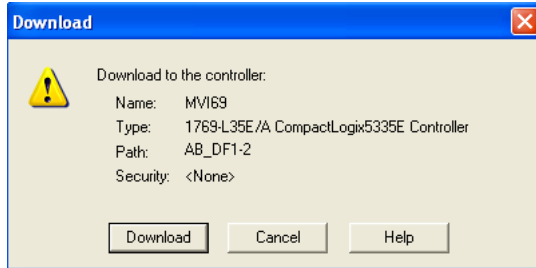

- 3 *RSLogix* will compile the program and transfer it to the processor. This process may take a few minutes.
- 4 When the download is complete, *RSLogix* will open another confirmation dialog box. Click **OK** to switch the processor from *PROGRAM* mode to *RUN* mode.

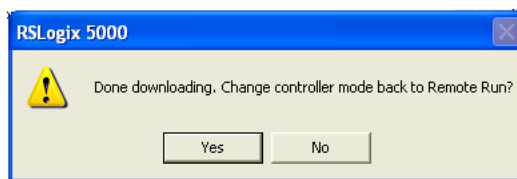

Note: If you receive an error message during these steps, refer to your *RSLogix* documentation to interpret and correct the error.

3 Optional AOI

The Optional AOI supports the following optional features:

- Read/Write IP Address
- Read/Write Date Time

Using controller tags, the Optional AOI allows you to request and set the module's IP address, date, and time. These optional features are not supported by the MVI69-GSC legacy module.

Note: The Optional AOI may be added to an existing legacy MVI69-GSC application to add the new functionality during a module replacement.

3.1 Importing the Optional AOI

- 1 Add a new rung to the existing processor ladder logic. Right-click on the new rung and select *Import Rungs...*

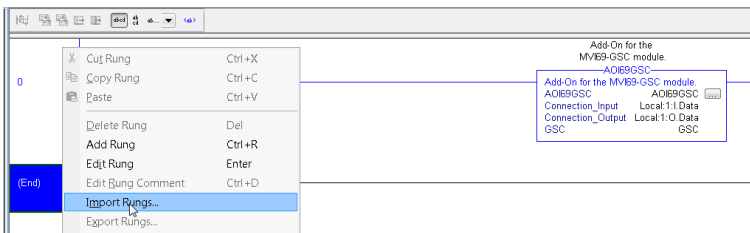

- 2 Select the Optional AOI file: *MVI69E_GSC_Optional_AddOn_Rung.L5X*

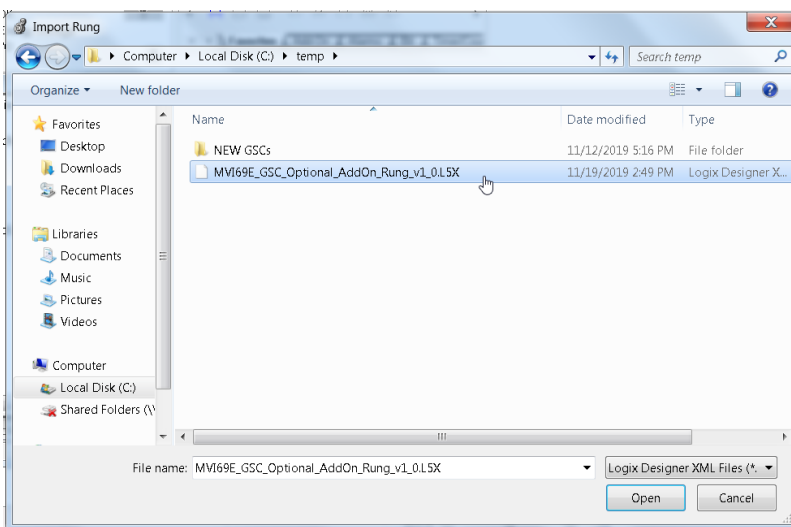

- At the *Import Configuration* window, select the *Operation* parameter to **CREATE**. Then click **OK**.

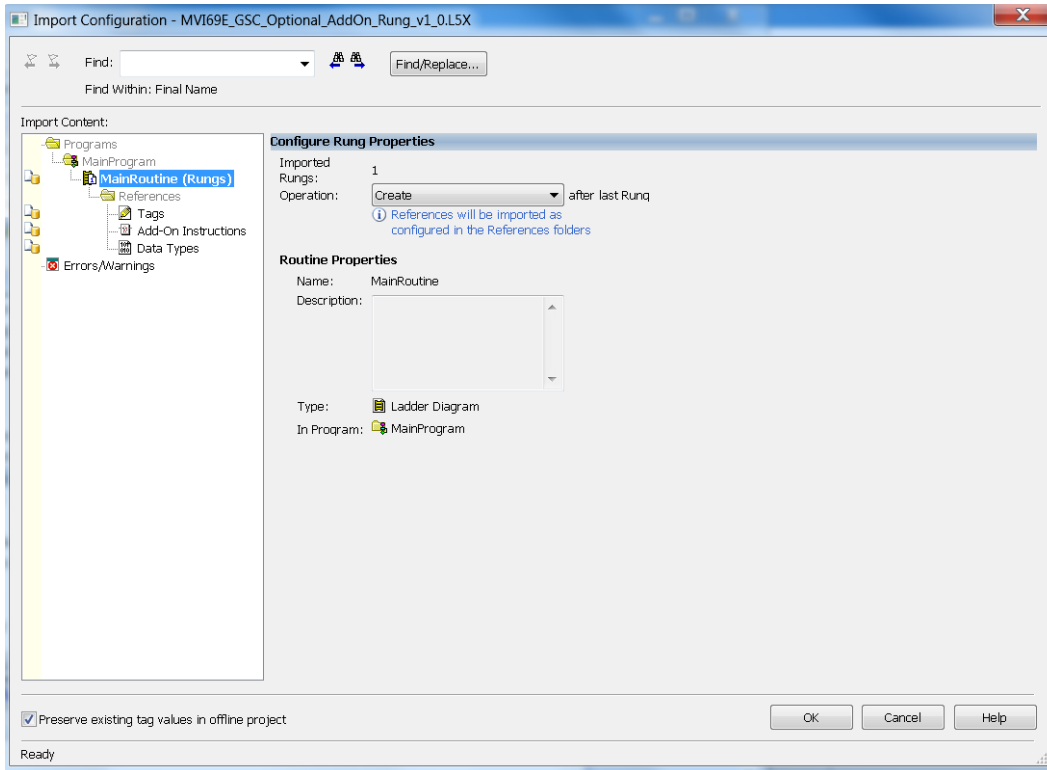

- The imported AOI rung is now in place.

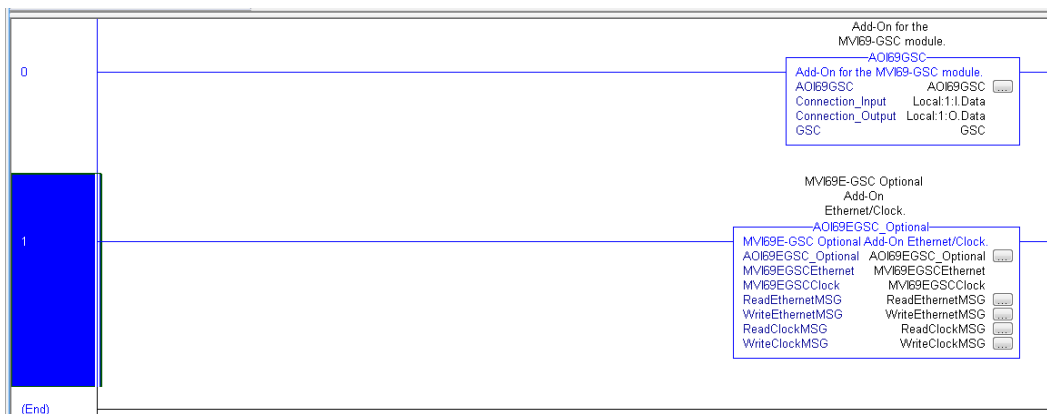

3.2 Setting up the Optional AOI

- 1 Click on the *ReadEthernetMSG*  icon to configure the message route:

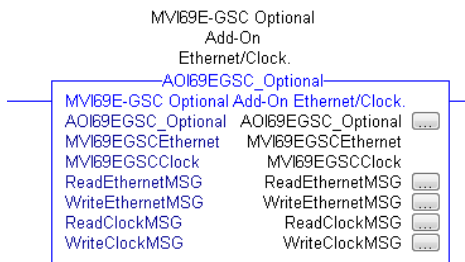

- 2 In the *Message Configuration* dialog, under the *Communication* tab, select the **BROWSE** button.

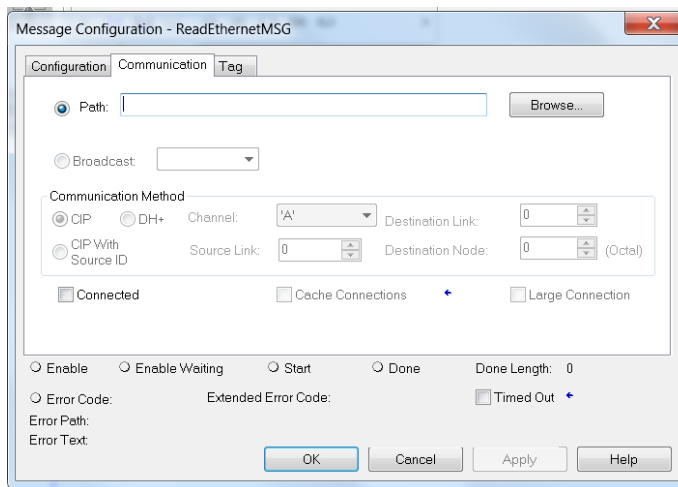

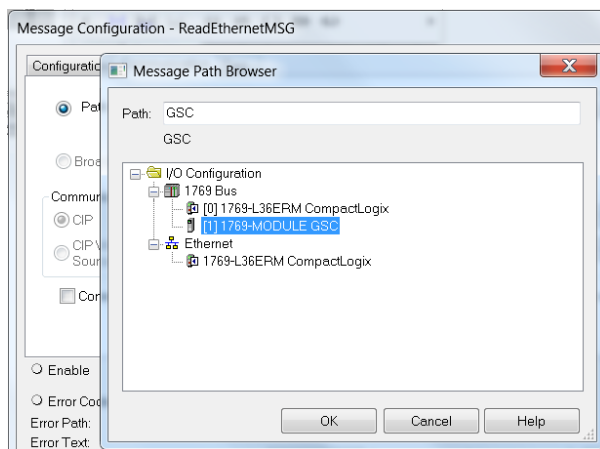

- 3 Select the MVI69E-GSC module configured at the 1769 Bus and click at **OK**.

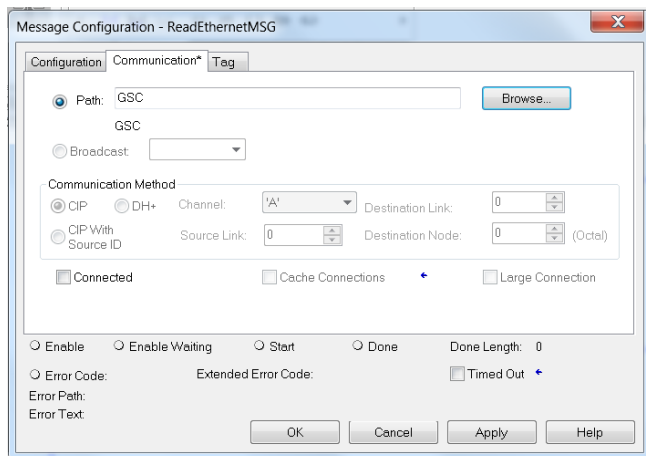

- 4 The module name is displayed at the path field. Select **OK** to confirm the route configuration.



- 5 Repeat the same procedure to set the route for the remaining messages:

- *WriteEthernetMSG* 
- *ReadClockMSG* 
- *WriteClockMSG* 

3.3 Synchronizing the IP Settings from the MVI69E-GSC to the Processor

This section covers the process to read the IP settings from the MVI69E-GSC, and implement them in the processor.

- 1 To trigger the IP settings read operation, set the *MVI69EGSCEthernet.Read* bit to '1'.

Name	Value
MVI69EGSCEthernet	{...}
MVI69EGSCEthernet.Read	1

- 2 Once the operation is concluded, the tag will be automatically reset to '0'

Name	Value
MVI69EGSCEthernet	{...}
MVI69EGSCEthernet.Read	0

- 3 The data is stored in the *MVI69EGSCEthernet.Config* tags (IP, Netmask, Gateway) as follows:

Name	Value
MVI69EGSCEthernet.Config	{...}
MVI69EGSCEthernet.Config.IP	{...}
MVI69EGSCEthernet.Config.IP[0]	192
MVI69EGSCEthernet.Config.IP[1]	168
MVI69EGSCEthernet.Config.IP[2]	0
MVI69EGSCEthernet.Config.IP[3]	250
MVI69EGSCEthernet.Config.Netmask	{...}
MVI69EGSCEthernet.Config.Netmask[0]	255
MVI69EGSCEthernet.Config.Netmask[1]	255
MVI69EGSCEthernet.Config.Netmask[2]	255
MVI69EGSCEthernet.Config.Netmask[3]	0
MVI69EGSCEthernet.Config.Gateway	{...}
MVI69EGSCEthernet.Config.Gateway[0]	192
MVI69EGSCEthernet.Config.Gateway[1]	168
MVI69EGSCEthernet.Config.Gateway[2]	0
MVI69EGSCEthernet.Config.Gateway[3]	1

3.4 Synchronizing the IP Settings from the Processor to the MVI69E-GSC

This section covers the process to send the IP settings from the processor to the MVI69E-GSC.

- 1 Populate the IP settings in the *MVI69EGSCEthernet.Config* tag:

Name	Value
[-] MVI69EGSCEthernet.Config	{ ... }
[-] MVI69EGSCEthernet.Config.IP	{ ... }
[+] MVI69EGSCEthernet.Config.IP[0]	192
[+] MVI69EGSCEthernet.Config.IP[1]	168
[+] MVI69EGSCEthernet.Config.IP[2]	0
[+] MVI69EGSCEthernet.Config.IP[3]	250
[-] MVI69EGSCEthernet.Config.Netmask	{ ... }
[+] MVI69EGSCEthernet.Config.Netmask[0]	255
[+] MVI69EGSCEthernet.Config.Netmask[1]	255
[+] MVI69EGSCEthernet.Config.Netmask[2]	255
[+] MVI69EGSCEthernet.Config.Netmask[3]	0
[-] MVI69EGSCEthernet.Config.Gateway	{ ... }
[+] MVI69EGSCEthernet.Config.Gateway[0]	192
[+] MVI69EGSCEthernet.Config.Gateway[1]	168
[+] MVI69EGSCEthernet.Config.Gateway[2]	0
[+] MVI69EGSCEthernet.Config.Gateway[3]	1

- 2 Set the *MVI69EGSCEthernet.Write* bit to '1' to trigger the IP settings write operation.

Name	Value
[-] MVI69EGSCEthernet.Write	1

- 3 The *MVI69EGSCEthernet.Write* bit will be automatically reset once the operation is concluded.

Name	Value
[-] MVI69EGSCEthernet.Write	0

3.5 Reading the Date/Time from the MVI69E-GSC to the Processor

- 1 Toggle the *MVI69EGSCClock.Read* bit to '1' to toggle the date/time read operation.

Name	Value
MVI69EGSCClock.Read	1

- 2 The *MVI69EGSCClock.Read* bit will be automatically reset once the operation is concluded.

Name	Value
MVI69EGSCClock.Read	0

- 3 The date and time read from the MVI69E-GSC is stored at the *MVI69EGSCClock.Config* tag.

Name	Value
MVI69EGSCClock.Config	{ . . . }
MVI69EGSCClock.Config.Year	2019
MVI69EGSCClock.Config.Month	11
MVI69EGSCClock.Config.Day	9
MVI69EGSCClock.Config.Hour	11
MVI69EGSCClock.Config.Minute	21
MVI69EGSCClock.Config.Seconds	34

3.6 Writing the Date/Time from the Processor to the MVI69E-GSC

- 1 Populate date and time values in the *MVI69EGSCClock.Config* tag.

Name	Value
MVI69EGSCClock.Config	{ ... }
MVI69EGSCClock.Config.Year	2019
MVI69EGSCClock.Config.Month	11
MVI69EGSCClock.Config.Day	9
MVI69EGSCClock.Config.Hour	11
MVI69EGSCClock.Config.Minute	21
MVI69EGSCClock.Config.Seconds	34

- 2 Toggle the *MVI69EGSCClock.Write* bit to '1' to trigger the write date/time operation.

Name	Value
MVI69EGSCClock.Write	1

- 3 The *MVI69EGSCClock.Write* tag will be automatically reset once the write date/time operation is concluded.

Name	Value
MVI69EGSCClock.Write	0

4 Using ProSoft Configuration Builder

ProSoft Configuration Builder (PCB) provides a quick and easy way to manage module configuration files customized to meet your application needs. *PCB* is not only a powerful solution for new configuration files, but also allows you to import information from previously installed (known working) configurations to new projects.

4.1 Installing ProSoft Configuration Builder Software

You must install the *ProSoft Configuration Builder (PCB)* software to configure the module. You can download the newest version of *ProSoft Configuration Builder* from www.prosoft-technology.com.

Installing ProSoft Configuration Builder from the ProSoft website

- 1 Open your web browser and navigate to <http://www.prosoft-technology.com/pcb>
- 2 Download the latest version of *ProSoft Configuration Builder*.
- 3 Choose **SAVE** or **SAVE FILE** when prompted.
- 4 Save the file to your *Windows Desktop*, so that you can find it easily when you have finished downloading.
- 5 When the download is complete, locate and open the file, and then follow the instructions on your screen to install the program.

4.2 Setting Up the Project

ProSoft Configuration Builder's window consists of a tree view on the left, an information pane and a configuration pane on the right side of the window.

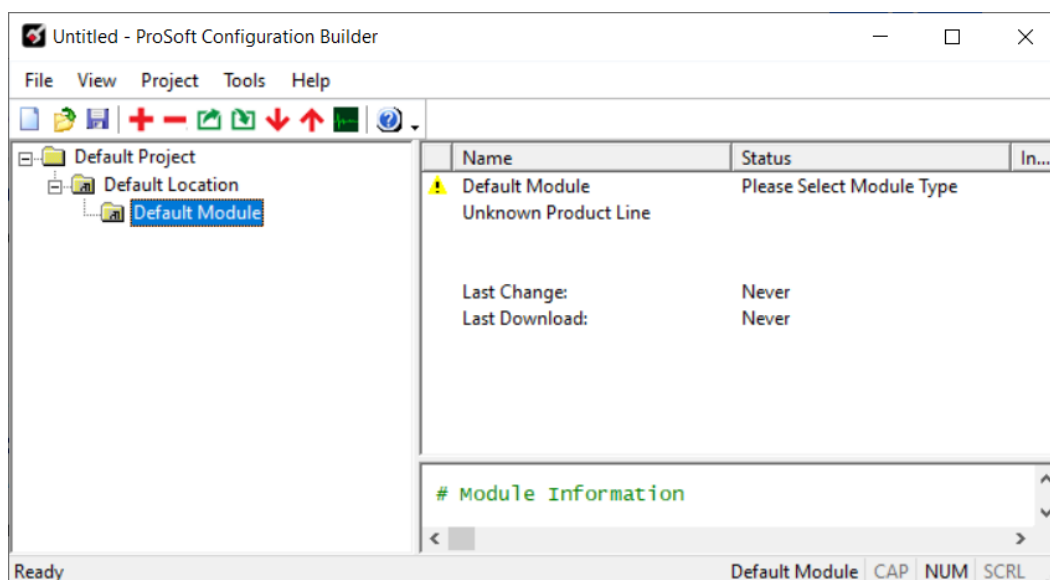

4.2.1 Adding the MVI69E-GSC module to the project.

- 1 Right click **DEFAULT LOCATION** (which you can rename) and choose **ADD MODULE**.

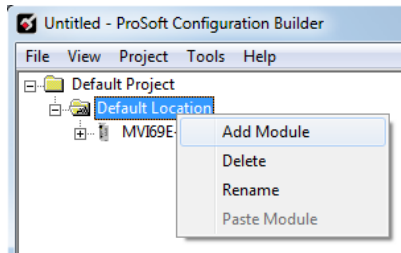

- 2 Right-click **NEW MODULE** and choose **CHOOSE MODULE TYPE**.

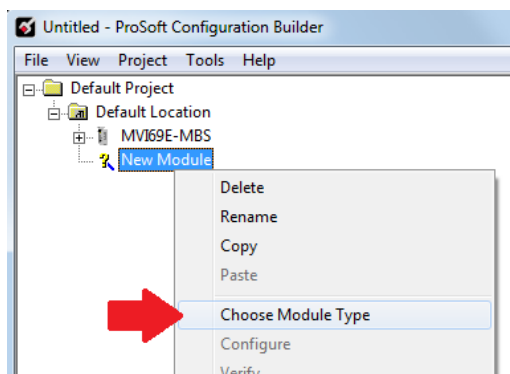

- 3 In the *Choose Module Type* dialog box, select **MVI69E** in the **PRODUCT LINE FILTER** area, and then select **MVI69E-GSC** as the **MODULE TYPE**. Click **OK**.

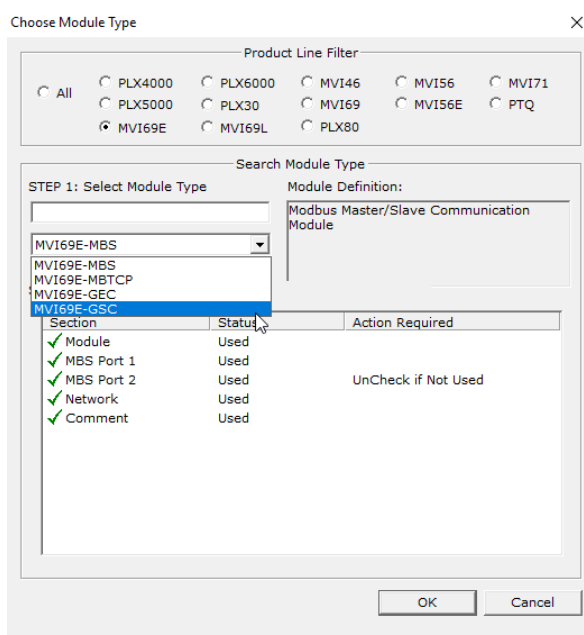

4.3 Renaming PCB Objects

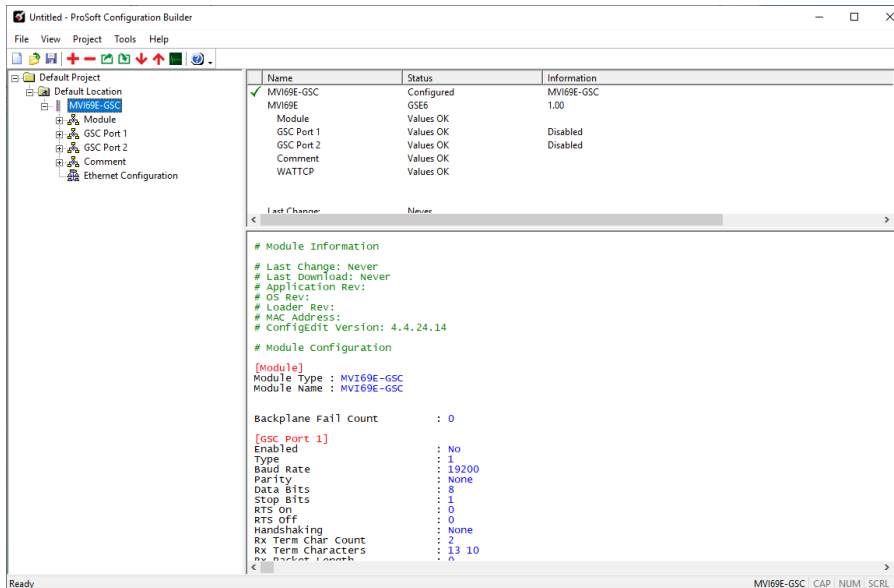

Notice that the contents of the information pane and the configuration pane changed when you added the module to the project.



At this time, you may wish to rename the *Default Project* and *Default Location* folders in the tree view.

- 1 Select the object, and then right-click the mouse button to open a shortcut menu. From the shortcut menu, choose **RENAME**.
- 2 Type the name to assign to the object.
- 3 Click away from the object to save the new name.

Configuring Module Parameters

- 1 Click on the **[+]** sign next to the module icon to expand module information.
- 2 Click on the **[+]** sign next to any  icon to view module information and configuration options.
- 3 Double-click any  icon to open an *Edit* dialog box.
- 4 To edit a parameter, select the parameter in the left pane and make your changes in the right pane.
- 5 Click **OK** to save your changes.

Printing a Configuration File

- 1 Select the module icon, and right-click the mouse button to open a shortcut menu.
- 2 On the shortcut menu, choose **VIEW CONFIGURATION**. This action opens the *View Configuration* window.
- 3 In the *View Configuration* window, open the **FILE** menu, and choose **PRINT**. This action opens the *Print* dialog box.
- 4 In the *Print* dialog box, choose the printer to use from the drop-down list, select printing options, and then click **OK**.

4.4 Module Configuration Parameters

This section describes the MVI69E-GSC parameters configured in ProSoft Configuration Builder.

4.4.1 Module Parameters

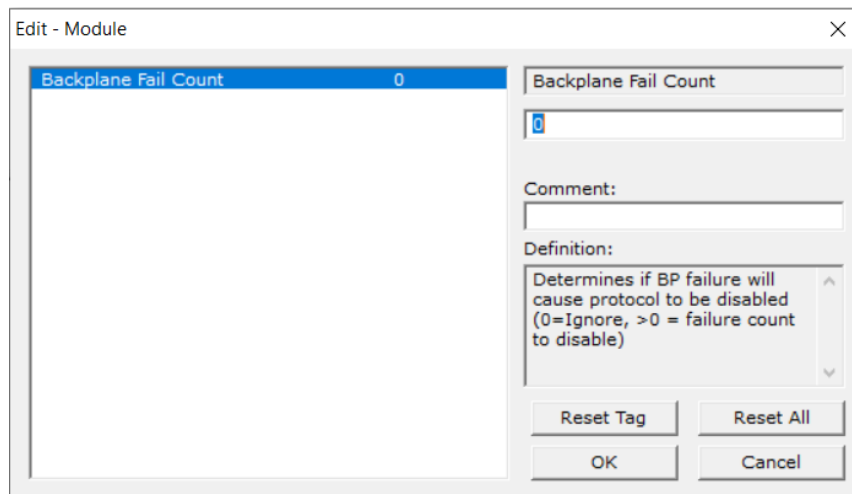
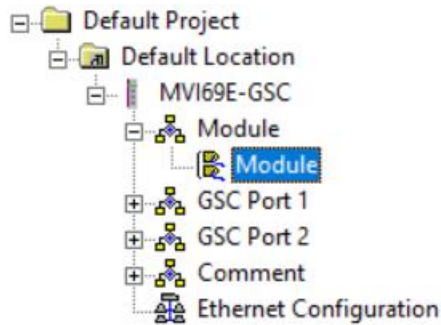

[Section]/Item	Range	Description
[MODULE]		Module section header
Backplane Fail Count:	0 to 65535	This parameter specifies the number of successive transfer errors that must occur before the communication ports are shut down. If the parameter is set to zero, the communication ports will continue to operate under all conditions. If the value is set larger than 0 (1 to 65535), communications will cease if the specified number of backplane failures occur.

4.4.2 GSC Port x Parameters

The GSC Port 1 and 2, respectively, have identical port parameters.

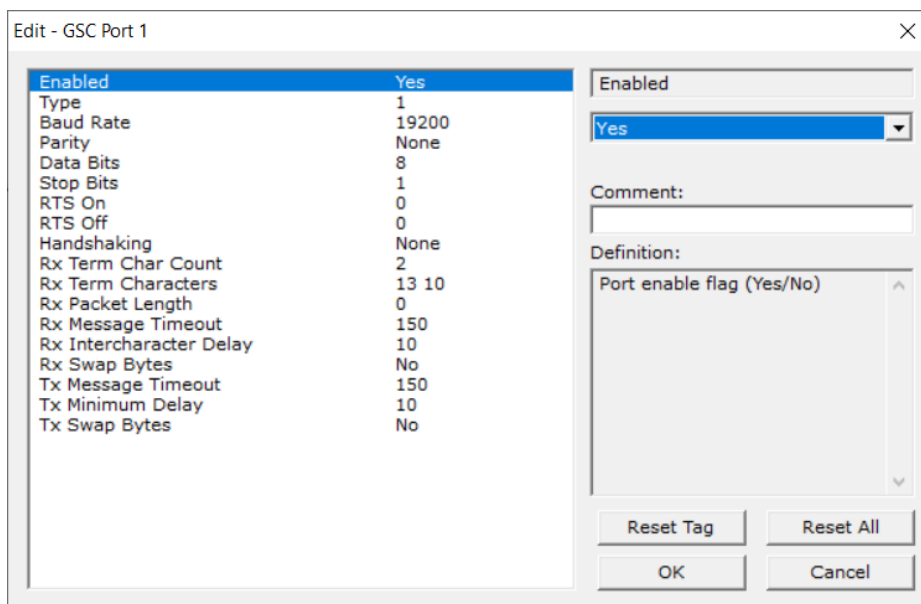
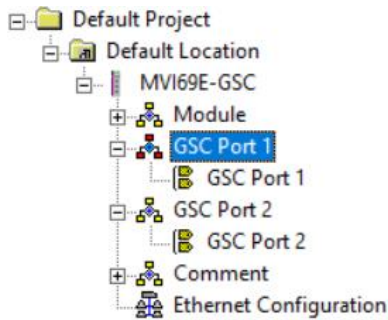

Parameter	Range	Description
[GSC Port 1 or 2]		MVI69E-GSC port definition header
Enabled	Yes or No	This parameter defines if this port will be utilized.
Type	0 to 15	This parameter specifies the receive termination characteristics for the port. This value is bit mapped as follows: Bit 0 = Termination character(s) used Bit 1 = Message timeout used Bit 2 = Intercharacter delay timeout used Bit 3 = Packet size limit used. If the parameter is set to zero, the port is placed in stream mode.
Baud Rate	From selected list of codes	This is the baud rate to be used on the port. Enter the baud rate as a value. For example, to select 19K baud, enter 19200. Valid entries for this field include: 110, 150, 300, 600, 1200, 2400, 4800, 9600, 19200, 384 or 3840 for 38400, 576 or 5760 for 57600 and 115 or 1150 for 115200.

Parameter	Range	Description
Parity	None, Even, Odd, Mark or Space	This is the Parity code to be used for the port.
Data Bits	5 to 8	This parameter sets the number of data bits for each word used by the protocol.
Stop Bits	1 or 2	This parameter sets the number of stop bits to be used with each data value sent.
RTS On	0 to 65535	This parameter sets the number of milliseconds to delay after RTS is asserted before the data will be transmitted.
RTS Off	0 to 65535	This parameter sets the number of milliseconds to delay after the last byte of data is sent before the RTS modem signal will be set low.
Handshaking	NONE, RTS/CTS, DTR/DSR or XON/XOFF	This parameter specifies the handshaking used on the port. The values are as follows: None = No hardware or software handshaking RTS/CTS = Hardware handshaking DTR/DSR = Hardware handshaking XON/XOFF = Software handshaking
Rx Term Char Count	0 to 12	This parameter is used if bit 0 of the <i>Type</i> parameter is set. This value (0 to 12) defines the number of termination characters used to define the end of received message.
Rx Term Characters	List of up to 12 integer values	This array of 12 integer values representing the characters used to define the termination characters at the end of each received message. The number of characters to be used in the array is set in the <i>RTermCnt</i> parameter.
Rx Packet Length	0 to 4096	This parameter is used if bit 3 is set in the <i>Type</i> parameter. The parameter sets the length of data required to be received on the port before transferring the data to the processor.
Rx Message Timeout	0 to 65535	This parameter is used if bit 1 is set in the <i>Type</i> parameter. The parameter sets the number of milliseconds to wait after the first character is received on the port before automatically sending the data to the processor.
Rx Intercharacter Delay	0 to 65535	This parameter is used if bit 2 is set in the <i>Type</i> parameter. The parameter sets the number of milliseconds to wait between each character received on the port before sending the data to the processor.
Rx Swap Bytes	Yes or No	This parameter specifies if the data received should have its bytes swapped before sending over the backplane.
Tx Message Timeout	0 to 65535	This parameter specifies the timeout period to transmit a message out the port. A message must be transmitted out the port within the specified timeout period. Message transmission will be aborted if the timeout is exceeded.
Tx Minimum Delay	0 to 65535	This parameter specifies the minimum number of milliseconds to delay before transmitting a message out the port. This pre-send delay is applied before the RTS on time. This may be required when communicating with slow devices.
Tx Swap Bytes	Yes or No	This parameter specifies if the data to be transmitted out the port will have the bytes swapped from the data presented across the backplane.

4.4.3 MVI69E-GSC IP Address Configuration

This section defines the permanent IP address, Subnet Mask, and Gateway of the module.

- 1 In the ProSoft Configuration Builder tree view, double-click the **ETHERNET 1** icon.

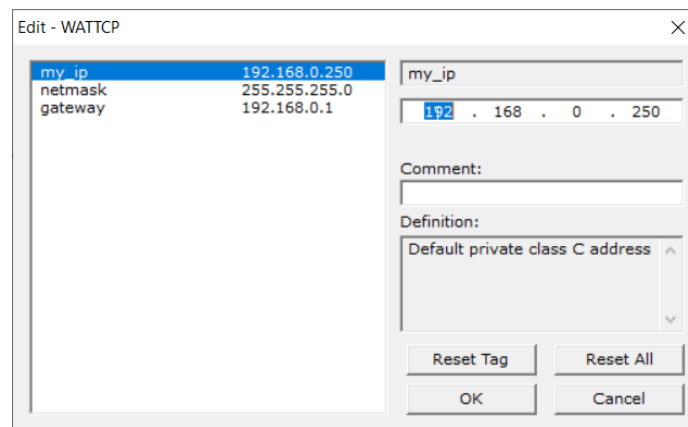
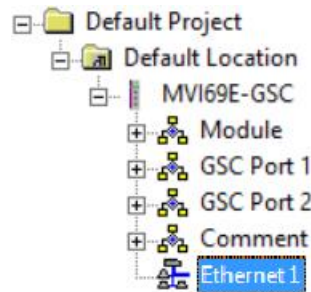

Parameter	Description
My_ip	Unique IP address assigned to the module
Netmask	Subnet mask of module
Gateway	Gateway (if used)

- 2 Click **OK** when complete.

4.5 Downloading the Configuration File to the Module

- 1 In the ProSoft Configuration Builder tree view, right-click the module icon and choose **DOWNLOAD FROM PC TO DEVICE**.

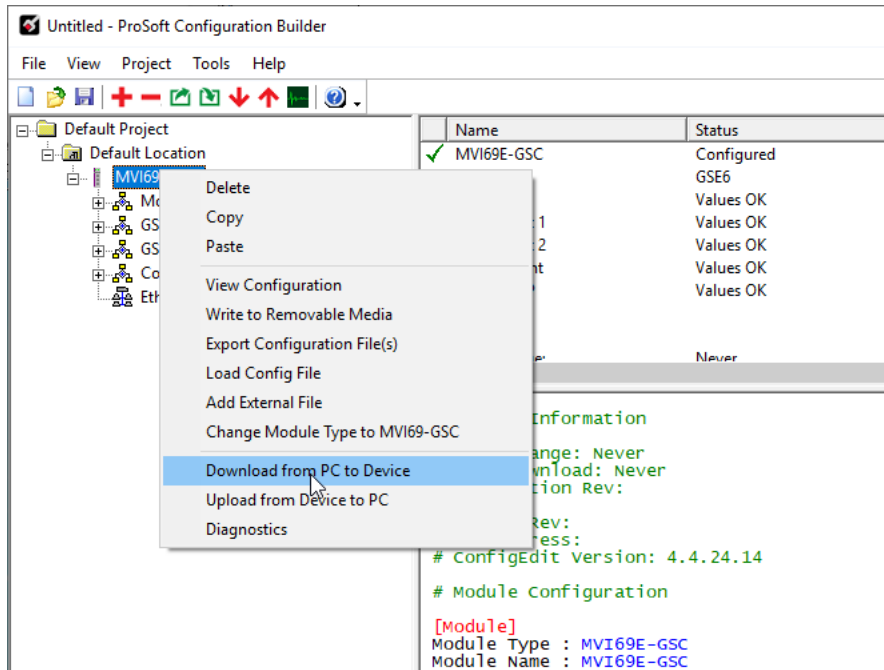

- 2 In the *Download Files from PC to Module* dialog box, select **BROWSE DEVICES**.

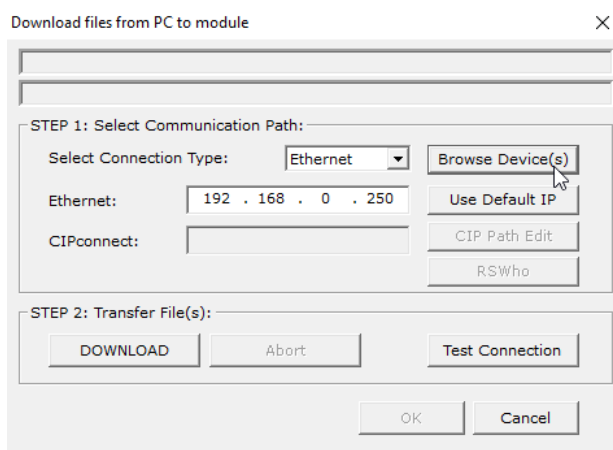

- 3 In the *ProSoft Discovery Service* dialog box, select the **MVI69E-GSC** module:

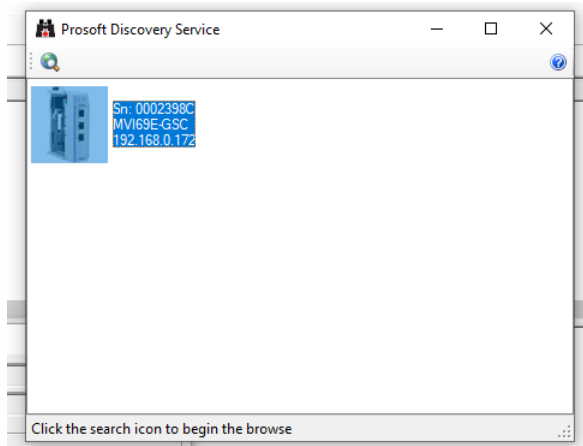

- 4 The *IP address* field is populated with the module's IP address. Click **DOWNLOAD** to confirm the operation:

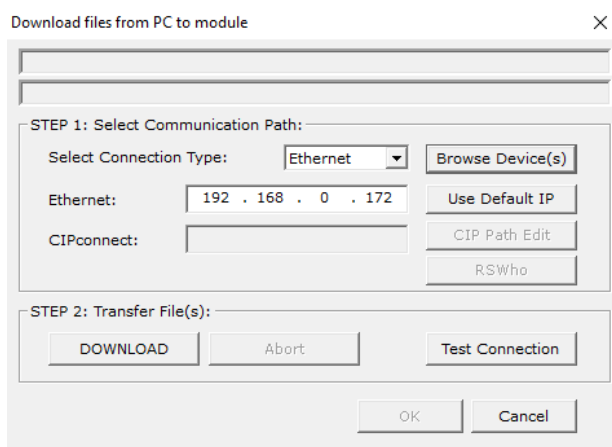

- 5 Once concluded, the status field shows 'Module Running'. Click **OK**.

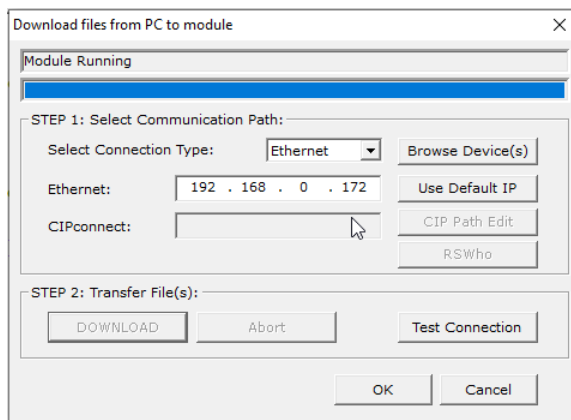

4.6 Uploading the Configuration File from the Module

- 1 In the ProSoft Configuration Builder tree view, right-click the **MVI69E-GSC** icon and choose **UPLOAD FROM DEVICE TO PC**.

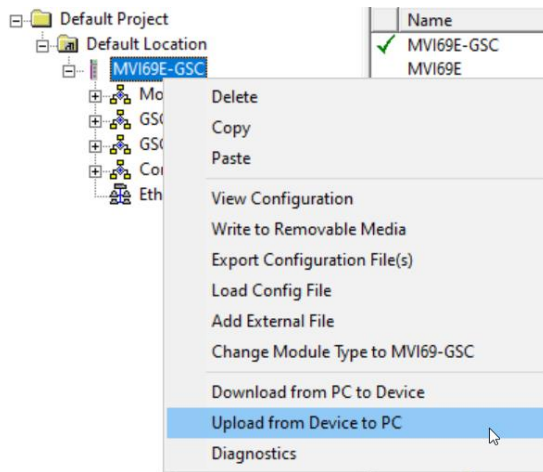

- 2 Click the **BROWSE DEVICE(S)** button.

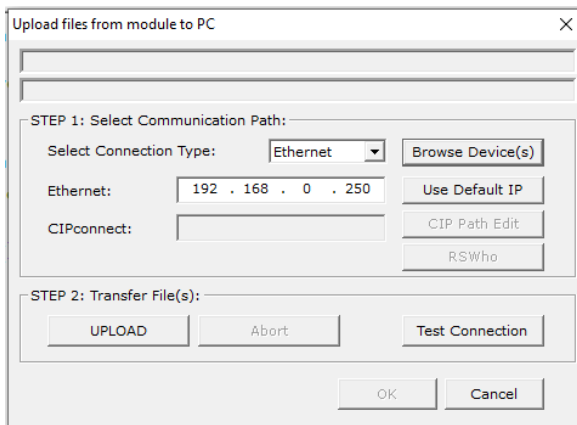

- 3 In the *ProSoft Discovery Service* dialog box, select the MVI69E-GSC module. The *Ethernet* field will be automatically populated with the module's IP address.

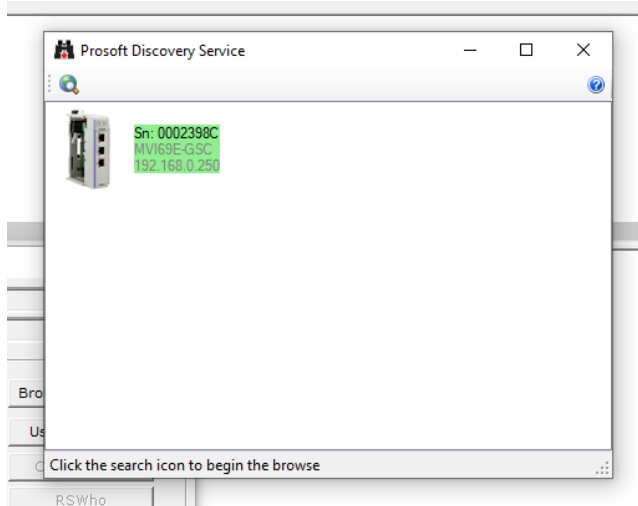

- 4 Once the file is uploaded, the following message is displayed:

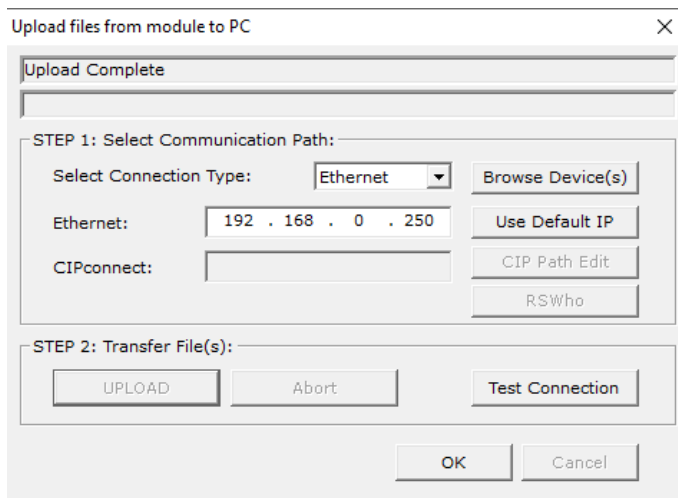

- 5 PCB now displays the uploaded configuration file.

4.7 Converting a Legacy MVI69-GSC to an MVI69E-GSC

The MVI69E-GSC product is backward compatible with the legacy MVI69-GSC product. You may replace the existing MVI69-GSC module with a new MVI69E-GSC without requiring any modifications to the existing ladder logic.

This section shows how to convert an existing MVI69-GSC project to a MVI69E-GSC.

- 1 In PCB, right-click on the module and select **CHANGE MODULE TYPE TO MVI69E-GSC**.

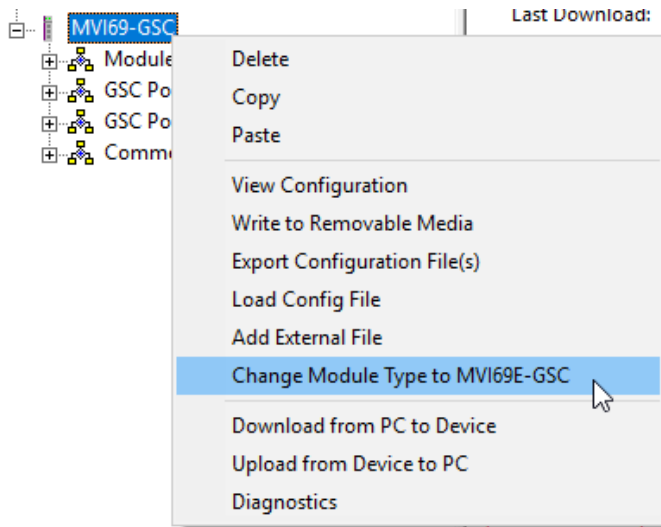

- 2 The legacy project will be converted to the MVI69E-GSC project with the same module settings:

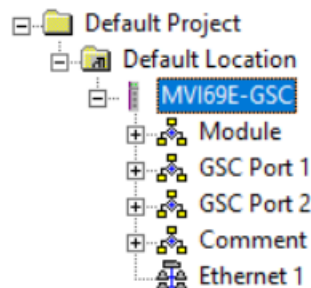

- 3 The new configuration file can now be downloaded to the MVI69E-GSC.

5 Using Controller Tags

The MVI69E-GSC data is stored in controller tags in the ladder logic. Controller tags are used to manage the communications between the MVI69E-GSC module and the CompactLogix or MicroLogix 1500-LRP processor:

- View the read and write data being transferred between the module and the processor.
- View status data for the module.
- Set up and trigger special functions.
- Initiate module restarts (Warm Boot or Cold Boot).

Individual controller tags can be grouped into collections of controller tags called controller tag structures. A controller tag structure can contain any combination of:

- Individual controller tags
- Controller tag arrays
- Lower-level controller tag structures

The controller tags are included in the MVI69E-GSC Add-On Instruction. After you import the Add-On Instruction, you can find the controller tags in the *Controller Tags* subfolder, located in the *Controller* folder in the *Controller Organizer* pane of the main Studio 5000 window.

The Add-On Instruction also includes user-defined data types (UDTs). UDTs are collections of data types and declares the data types for the controller tag structures.

The MVI69E-GSC Add-On Instruction is extensively commented to provide information on the purpose and function of each user-defined data type and controller tag. For most applications, the Add-On Instruction works without needing any modification.

5.1 MVI69E-GSC Controller Tags

The main controller tag structure, GSC, is broken down into four lower-level controller tag structures.

[-] GSC
+ GSC.DATA
+ GSC.STATUS
+ GSC.CONTROL
+ GSC.UTIL

The four lower-level controller tag structures contain other controller tags and controller tag structures. Click the **[+]** sign next to any controller tag structure to expand it and view the next level in the structure.

For example, if you expand the *GSC.DATA* controller tag structure, it contains two controller tags; *GSC.DATA.Port1* and *GSC.DATA.Port2*, which stores the data received/sent to each port.

[-] GSC	{ ... }
[-] GSC.DATA	{ ... }
[-] GSC.DATA.Port1	{ ... }
+ GSC.DATA.Port1.ReadString	{ ... }
+ GSC.DATA.Port1.WriteLength	0
+ GSC.DATA.Port1.WriteString	{ ... }
+ GSC.DATA.Port1.ArrayIndex	0
+ GSC.DATA.Port1.RSindex	0
[-] GSC.DATA.Port2	{ ... }
+ GSC.DATA.Port2.ReadString	{ ... }
+ GSC.DATA.Port2.WriteLength	0
+ GSC.DATA.Port2.WriteString	{ ... }
+ GSC.DATA.Port2.ArrayIndex	0
+ GSC.DATA.Port2.RSindex	0
+ GSC.STATUS	{ ... }
+ GSC.CONTROL	{ ... }
+ GSC.UTIL	{ ... }

The controller tags in the Add-On Instruction are commented in the **DESCRIPTION** column.

5.2 User-Defined Data Types (UDTs)

User-defined data types (UDTs) allow you to organize collections of data types into groupings. You can use these groupings, or data type structures, to declare the data types for controller tag structures. Another advantage of defining a UDT is that you may reuse it in other controller tag structures that use the same data types.

The Add-On Instruction for the MVI69E-GSC module has pre-defined UDTs. You can find them in the *User-Defined* subfolder, located in the *Data Types* folder in the *Controller Organizer* pane of the main RSLogix window. Like the controller tags, the UDTs are organized in a multiple-level tree structure.

5.2.1 MVI69E-GSC User-Defined Data Types

Several UDTs are defined for the MVI69E-GSC Add-On Instruction. The main UDT (*GSCModuleDef*) contains all the data types for the module. There are several UDTs that are one level below *GSCModuleDef*.

These lower-level UDTs were used to create the *GSC.DATA*, *GSC.STATUS*, *GSC.CONTROL*, and *GSC.UTIL* controller tag structures.

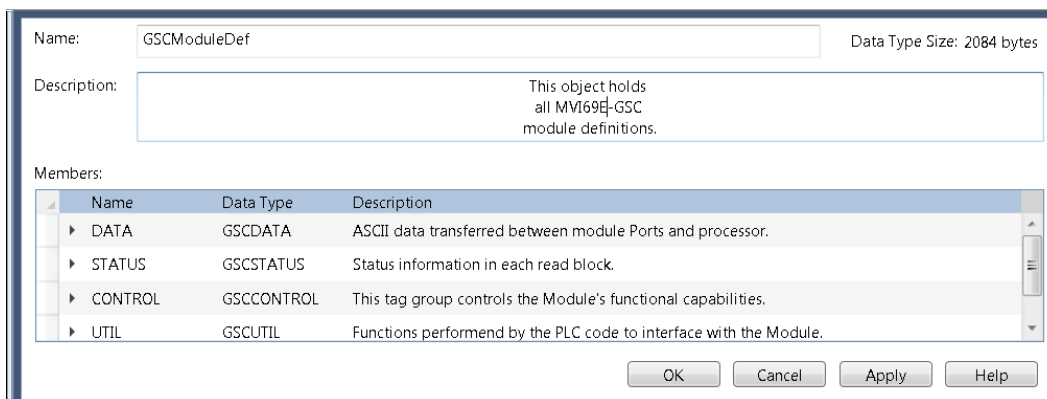

5.3 GSC Controller Tag Overview

This section details the GSC controller tags.

Tag Name	Description
GSC.DATA	Port 1 and Port 2 tags for data transfer
GSC.STATUS	Status information
GSC.CONTROL	Tasks that the processor may request from the module.
GSC.UTIL	Generic tags used for internal ladder processing (DO NOT MODIFY)

5.3.1 GSC.DATA

GSC.DATA contains the controller tags required for data exchange between the processor and the remote serial devices. This data contains one sub tag for each serial port (Port 1 and Port 2):

Name
[-] GSC
[-] GSC.DATA
+ GSC.DATA.Port1
+ GSC.DATA.Port2

Each port tag contains the following controller tags for data exchange:

Name
[-] GSC
[-] GSC.DATA
[-] GSC.DATA.Port1
+ GSC.DATA.Port1.ReadString
+ GSC.DATA.Port1.WriteLength
+ GSC.DATA.Port1.WriteString
+ GSC.DATA.Port1.ArrayIndex
+ GSC.DATA.Port1.RSIndex

Note: The *ArrayIndex* and *RSIndex* tags are updated by the AOI logic to process the data transfer. Your application should not have to access these tags.

5.3.2 GSC.STATUS

The *GSC.STATUS* tag stores the module, backplane, and port diagnostics:

Name	Value
- GSC	{...}
+ GSC.DATA	{...}
- GSC.STATUS	{...}
+ GSC.STATUS.PassCnt	-21656
+ GSC.STATUS.Product	{...}
+ GSC.STATUS.Rev	{...}
+ GSC.STATUS.OP	{...}
+ GSC.STATUS.Run	{...}
+ GSC.STATUS.BlockSteus	{...}
+ GSC.STATUS.Port1	{...}
+ GSC.STATUS.Port2	{...}

For further information about each diagnostics tag, please refer to the *Status Data Definition* section.

5.3.3 GSC.CONTROL

The *GSC.CONTROL* tag contains all control tasks that may be requested by the processor to the module. The MVI69E-GSC supports two control operations: Warmboot and Coldboot.

To perform a module reboot (Warmboot or Coldboot), toggle the associated controller tag to '1'. The AOI logic will automatically reset the tag back to '0'.

Name	Value
- GSC.CONTROL	{...}
- GSC.CONTROL.WarmBoot	0
- GSC.CONTROL.ColdBoot	0

6 Transmitting ASCII Data

6.1 Sending ASCII Strings from the Processor to a Serial Device

- 1 In order to send data from the processor to a remote serial device, you must first copy the source data to the *GSC.DATA.PortX.WriteString* array tag:

Name	Value
+ GSC.DATA.Port1.WriteLength	0
- GSC.DATA.Port1.WriteString	{ . . . }
+ GSC.DATA.Port1.WriteString[0]	'T'
+ GSC.DATA.Port1.WriteString[1]	'H'
+ GSC.DATA.Port1.WriteString[2]	'I'
+ GSC.DATA.Port1.WriteString[3]	'S'
+ GSC.DATA.Port1.WriteString[4]	' '
+ GSC.DATA.Port1.WriteString[5]	'I'
+ GSC.DATA.Port1.WriteString[6]	'S'
+ GSC.DATA.Port1.WriteString[7]	' '
+ GSC.DATA.Port1.WriteString[8]	'A'
+ GSC.DATA.Port1.WriteString[9]	' '
+ GSC.DATA.Port1.WriteString[10]	'T'
+ GSC.DATA.Port1.WriteString[11]	'E'
+ GSC.DATA.Port1.WriteString[12]	'S'
+ GSC.DATA.Port1.WriteString[13]	'T'

- 2 In the *GSC.DATA.PortX.WriteLength* tag, enter the number of characters to send. Once the AOI detects a non-zero value in the tag, the string data is sent to the remote serial device.

Name	Value
* + GSC.DATA.Port1.WriteLength	14

- 3 Once the operation is concluded, the AOI will automatically reset the WriteLength tag to '0'.

Name	Value
+ GSC.DATA.Port1.WriteLength	0

- 4 String diagnostics.
You can check the status of the data transmission by monitoring the *GSC.STATUS.Port1.TxMsgCnt* (transmitted message count) and *GSC.STATUS.Port1.TxCharCnt* (transmitted character count) tags.

6.2 Receiving ASCII Strings from a Serial Device to the Processor

The MVI69E-GSC continuously buffers the data received from remote serial devices until the criteria to flush the data to the processor is met. The criteria to interrupt data buffering and flush the data to processor is determined by the *Type* configuration parameter which includes a combination of the following options:

- Termination Characters
- Message Timeout
- Intercharacter Delay
- Packet Size

For further information about the *Type* configuration parameter, refer to section **GSC Port x Parameters**

The serial data received on the port is copied to the *GSC.DATA.PortX ReadString* tag.

Name	Value
[-] GSC	{ ... }
[-] GSC.DATA	{ ... }
[-] GSC.DATA.Port1	{ ... }
[-] GSC.DATA.Port1.ReadString	{ ... }
[+] GSC.DATA.Port1.ReadString[0]	'D'
[+] GSC.DATA.Port1.ReadString[1]	'A'
[+] GSC.DATA.Port1.ReadString[2]	'T'
[+] GSC.DATA.Port1.ReadString[3]	'A'
[+] GSC.DATA.Port1.ReadString[4]	' '
[+] GSC.DATA.Port1.ReadString[5]	' '

Note: Monitor the *GSC.STATUS.PortX* tag to indicate an incoming string has been received on the port. Copy the string from the *GSC.DATA.PortX ReadString* array to another array since the *GSC.DATA.PortX ReadString* array will be overwritten by subsequent, incoming strings.

7 Diagnostics and Troubleshooting

The module provides information on diagnostics and troubleshooting in the following forms:

- LED status indicators on the front of the module provide general information on the module's status.
- Status data contained in the module can be viewed through the Configuration/Debug port, using the troubleshooting and diagnostic capabilities of *ProSoft Configuration Builder (PCB)*.
- Status data values can be transferred from the module to processor memory and can be monitored there manually or by customer-created logic. For details on Status Data values, see MVI69E-GSC Status Data Area.

7.1 LED Status Indicators

The LEDs indicate the module's operating status as follows:

LED	Status	Indication
ETH	On	Ethernet communications are OK
	Off	No Ethernet cable connected
P1	Green	Data is being transferred
	Red	Not used
	Off	No serial communication activity
P2	Green	Data is being transferred
	Red	Not used
	Off	No serial communication activity
CFG	Green	Configuration is OK
	Yellow	Module is reading configuration
	Red	Configuration error
	Off	Module did not establish connection with processor or the processor is in program mode
BP	Green	The LED is on when the module is performing a write operation on the backplane. Under normal operation, the LED should blink rapidly on and off.
	Red	Backplane error, processor fault, processor in program mode
OK	Green	Module is OK
	Red	The program has detected an error or is being configured. If the LED remains red for over 10 seconds, the program has probably halted.

If the BP ACT and OK LEDs blink at a rate of every one-second, this indicates a serious problem with the module. Call ProSoft Technology support to arrange for repairs.

7.2 Ethernet LED Indicators

The Ethernet LEDs indicate the module's Ethernet port status.

LED	State	Description
100 Mbit	Off	Ethernet connected at 10Mbps duplex speed
	Amber Solid	Ethernet connected at 100Mbps duplex speed
LINK/ACT	Off	No physical network connection is detected. No Ethernet communication is possible. Check wiring and cables.
	Green Solid or Blinking	Physical network connection detected. This LED must be ON solid for Ethernet communication to be possible.

7.3 Clearing a Fault Condition

Typically, if the OK LED turns red for more than ten seconds, a hardware problem has been detected in the module or the program has exited.

To clear the condition, follow these steps:

- 1 Turn off power to the rack.
- 2 Remove the card from the rack.
- 3 Verify that all jumpers are set correctly.
- 4 Re-insert the card in the rack and turn the power back on.
- 5 Verify correct configuration data is being transferred to the module from the CompactLogix or MicroLogix controller.

If the module's OK LED does not turn green, verify that the module is inserted completely into the rack. If this does not resolve the problem, contact ProSoft Technology Technical Support.

7.4 Troubleshooting

Use the following troubleshooting steps if you encounter problems when the module is powered up. If these steps do not resolve your problem, please contact ProSoft Technology Technical Support.

Processor Errors

Problem description	Steps to take
Processor fault	Verify that the module is securely plugged into the slot that has been configured for the module in the I/O Configuration in RSLogix. Verify that the slot location in the rack has been configured correctly in the ladder logic.
Processor I/O LED flashes	This indicates a problem with backplane communications. A problem could exist between the processor and any installed I/O module, not just the MVI69E-GSC. Verify that all modules in the rack are correctly configured.

Module Errors

Problem description	Steps to take
BP ACT LED remains Off or blinks slowly	This indicates that backplane transfer operations are failing. To establish backplane communications, verify the following items: <ul style="list-style-type: none"> ▪ The processor is in RUN or REM RUN mode. ▪ The backplane driver is loaded in the module. ▪ The module is configured for read and write data block transfer. ▪ The ladder logic handles all read and write block situations. ▪ The module is properly configured in the processor I/O configuration and ladder logic.
OK LED remains red	The program has halted or a critical error has occurred. If the program has halted, turn off power to the rack, remove the card from the rack, then re-insert it, and then restore power to the rack.

7.5 Configuring a Temporary IP Address

This feature is useful if your laptop is on a different subnet than the module's IP address. The module can be configured to use the same subnet as your laptop.

Important: ProSoft Configuration Builder (PCB) locates MVI69E-GSC modules through UDP broadcast messages. These messages may be blocked by routers or layer 3 switches. In that case, **ProSoft Discovery Service** is unable to locate the modules.

To use **PCB**, arrange the Ethernet connection so that there is no router/ layer 3 switch between the computer and the module, OR reconfigure the router/ layer 3 switch to allow routing of the UDP broadcast messages.

- 1 In the tree view in **ProSoft Configuration Builder (PCB)**, select the **MVI69E-GSC** module.

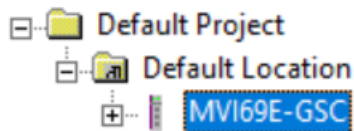

- 2 Right-click the module icon in the tree and choose **DIAGNOSTICS**.

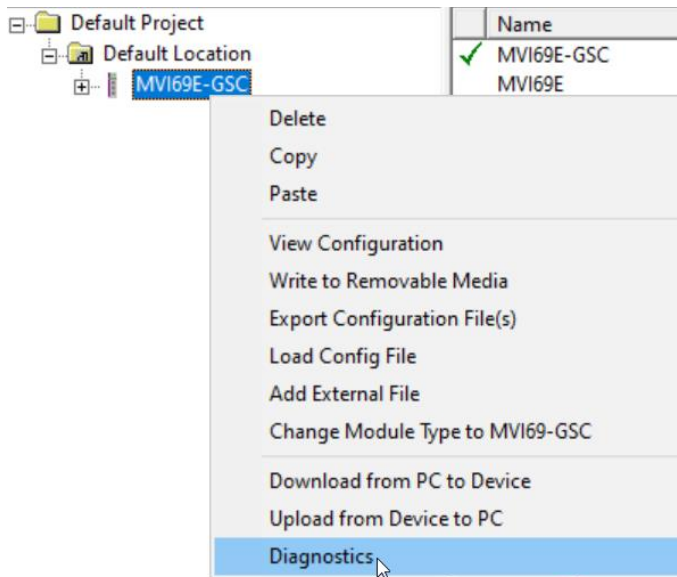

- 3 In the *Diagnostics* window, click the **SET UP CONNECTION** button.



Click to set up connection

- 4 In the *Connection Setup* dialog box, click **BROWSE DEVICE(S)** to start *ProSoft Discovery Service*. Right-click the module and choose **ASSIGN TEMPORARY IP**.

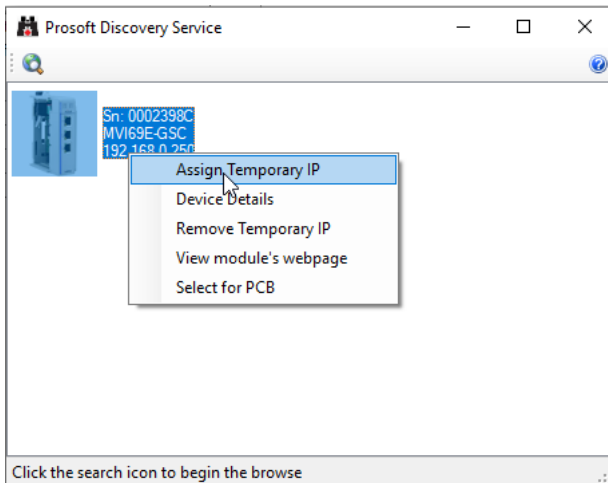

- 5 The module's default IP address is usually 192.168.0.250. Choose an unused IP within your subnet, and then click **OK**.

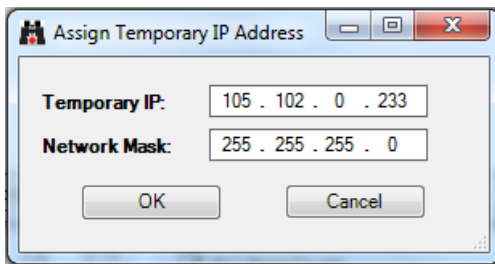

Important: The temporary IP address is only valid until the next time the module is initialized.

- 6 Close the *ProSoft Discovery Service* window. Enter the temporary IP address in the **ETHERNET ADDRESS** field of the *Connection Setup* dialog box, then click **TEST CONNECTION** to verify that the module is accessible with the current settings.
- 7 If the *Test Connection* is successful, click **CONNECT**. The *Diagnostics* window is now accessible.

ProSoft Configuration Builder (PCB) provides diagnostic menus for debugging and troubleshooting.

7.6 Diagnostics Menu

- 1 In the tree view in ProSoft Configuration Builder, right-click the **MVI69E-GSC** module and then choose **DIAGNOSTICS**.

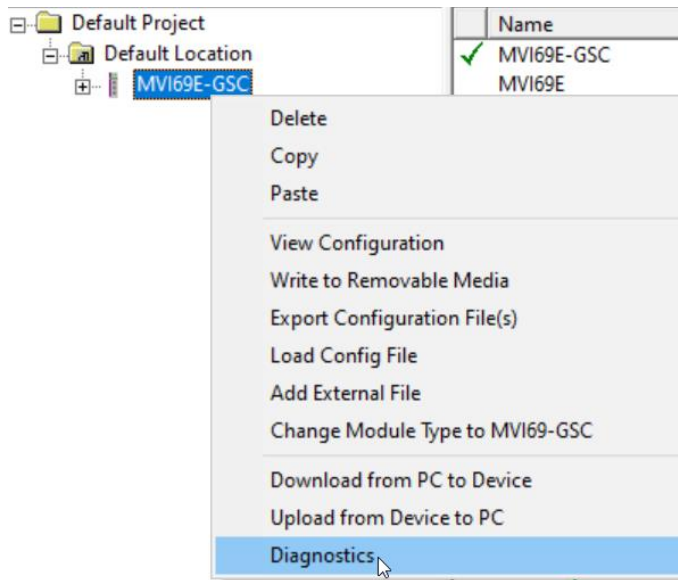

- 2 After the *Diagnostics* window opens, click the **SET UP CONNECTION** button to browse for the module's IP address.



Click to set up connection

- 3 In the *Ethernet* field of the *Connection Setup* dialog box, enter the current IP address, whether it is temporary or permanent. Click **TEST CONNECTION** to verify that the module is accessible with the current settings.

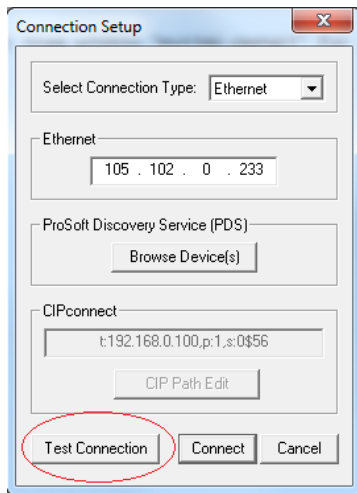

- 4 If the **TEST CONNECTION** is successful, click **CONNECT**. The *Diagnostics* window is now visible.

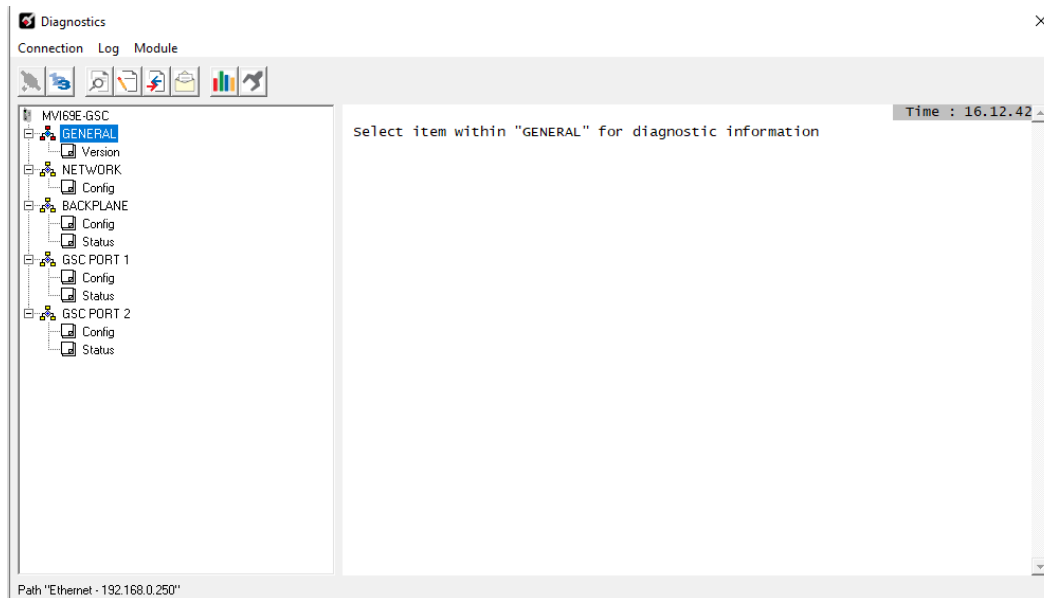

7.6.1 Diagnostics Menu Navigation

In the *Diagnostics* window in ProSoft Configuration Builder, the Diagnostics menu is available through the Ethernet configuration port. The menu is arranged as a tree structure.

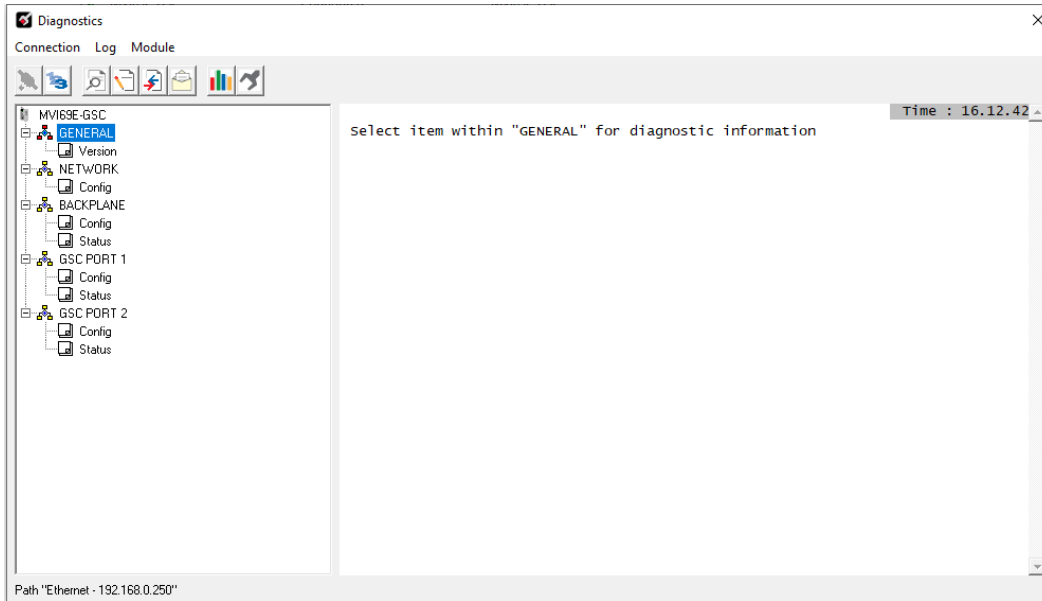

7.6.2 Monitoring Network Configuration Information

In the *Diagnostics* window in Prosoft Configuration Builder, click **NETWORK** and then click **CONFIG** to view the Ethernet network configuration information.

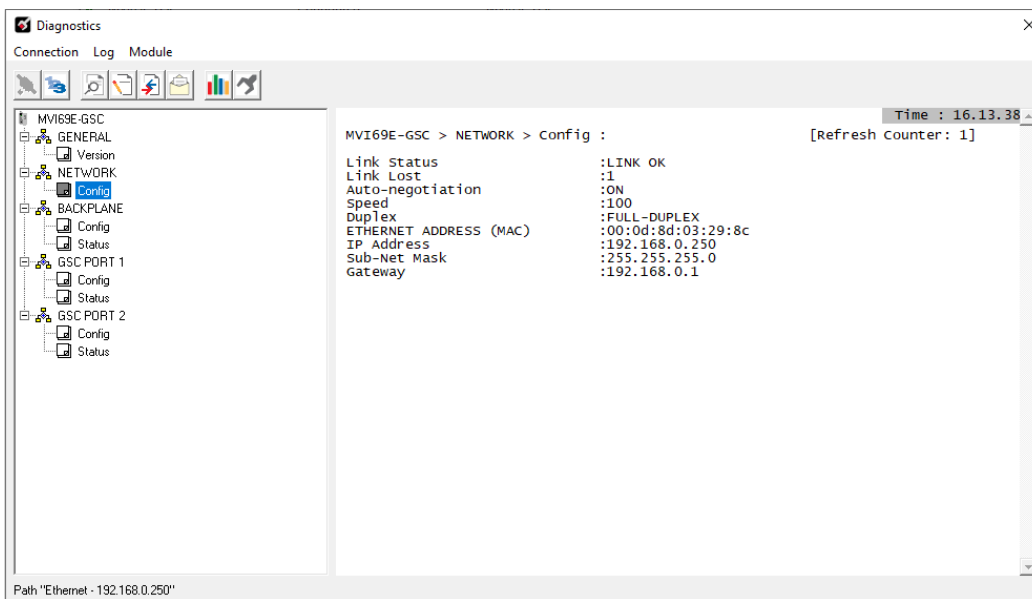

7.6.3 Monitoring Backplane Information

In the *Diagnostics* window in ProSoft Configuration Builder, click **BACKPLANE** to view the backplane information. This menu has two submenus:

- **CONFIGURATION**
- **STATUS**

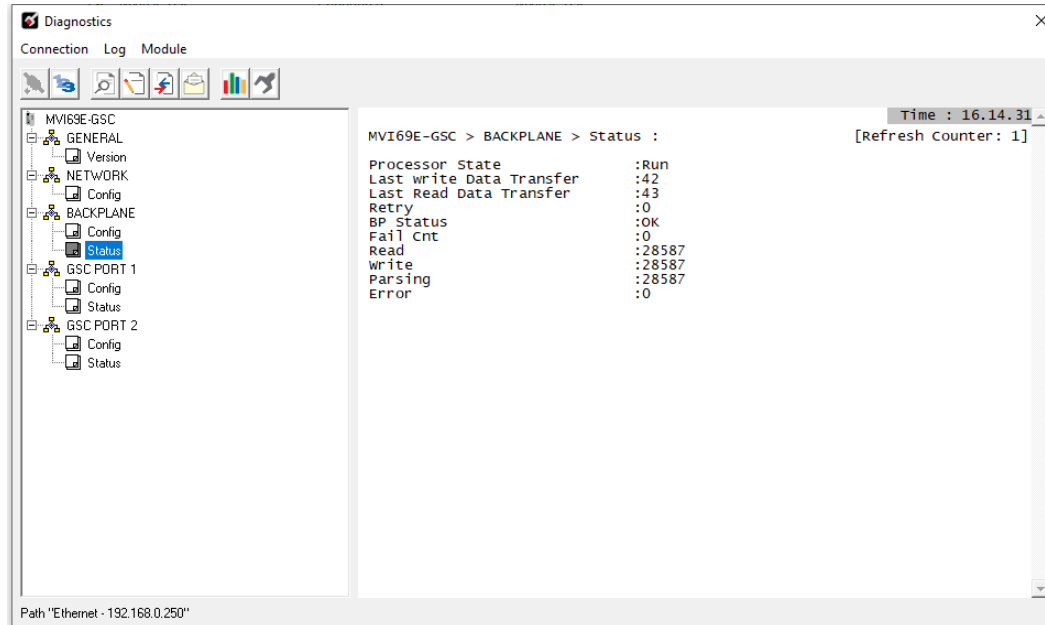
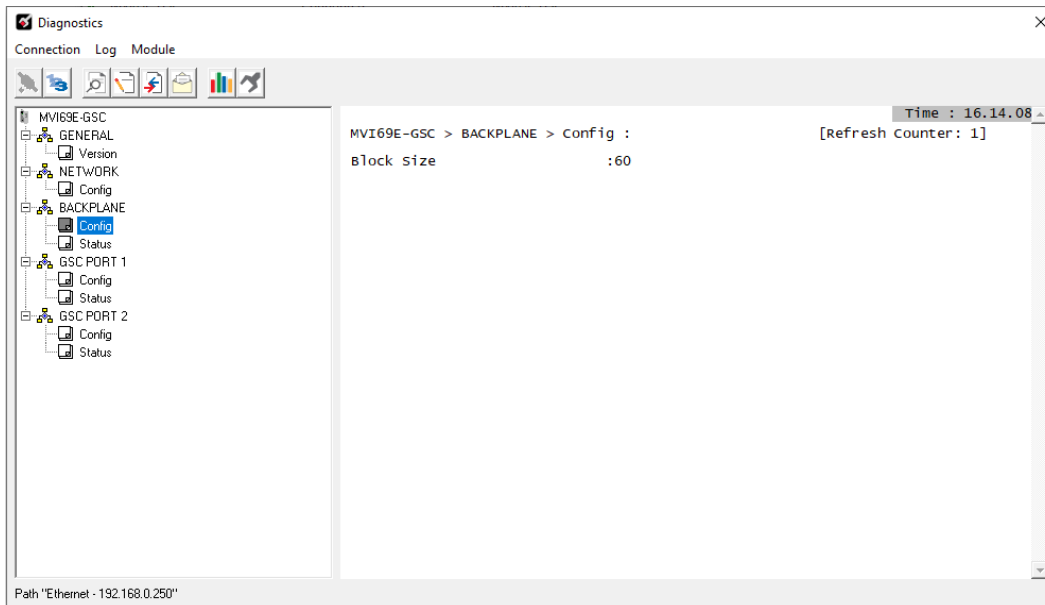

7.6.4 Port x Module Information

The **GSC Port 1** and **GSC Port 2** menus include the following submenus:

- Configuration
- Status (General status for the port)

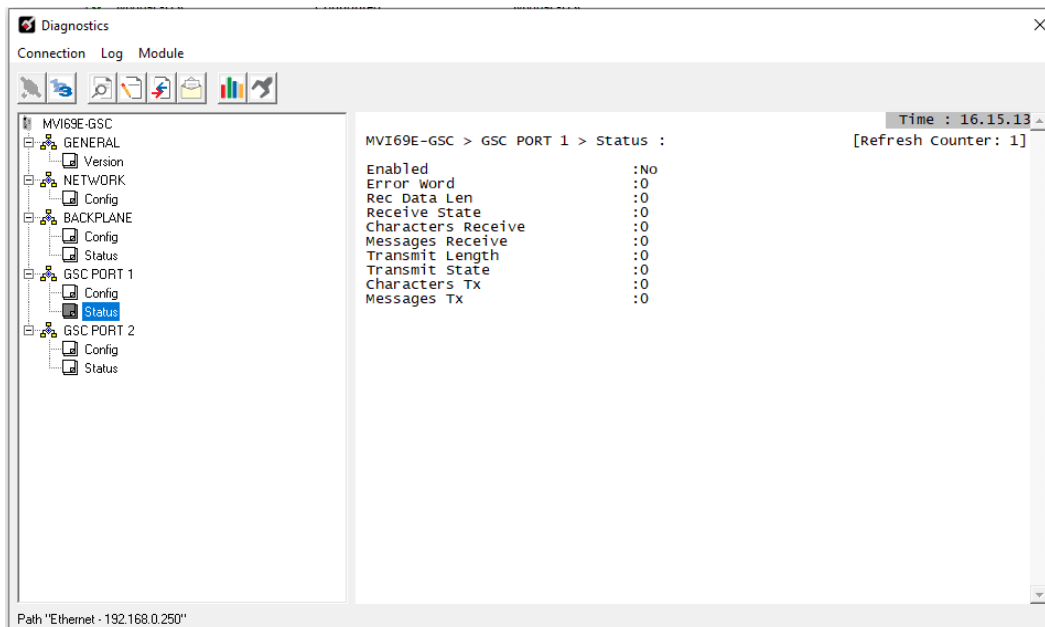
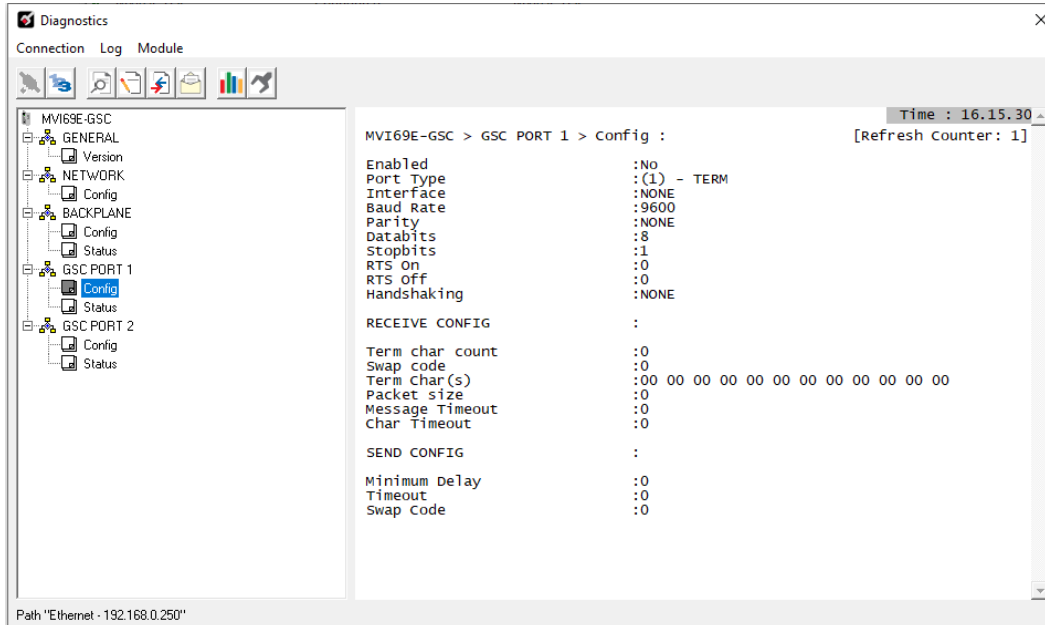

7.6.5 Data Analyzer

The Data Analyzer feature allows you to view the serial communications traffic as it is received and sent from the selected MVI69E-GSC communications port.

- 1 Click on the **SETUP DATA ANALYZER** icon.

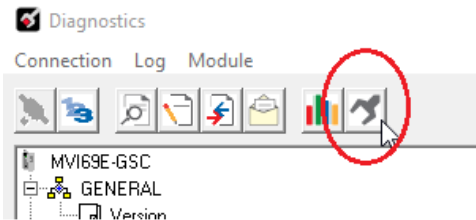

- 2 Select the *Time Tick* setting, the port number, and the data format.

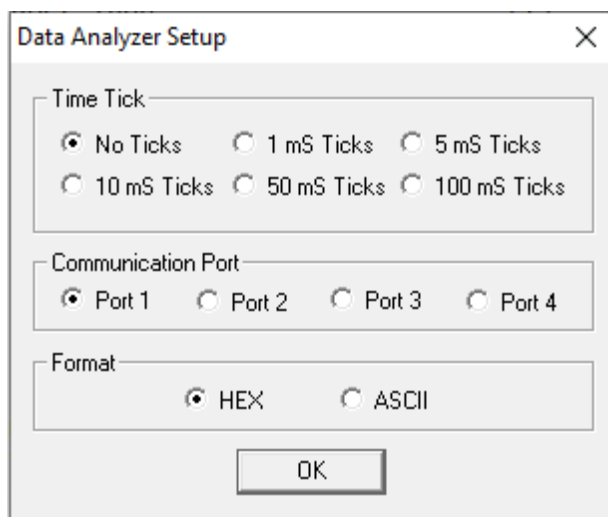

- 3 Click **OK** to confirm.
- 4 Select the **START DATA ANALYZER** button to start the data analyzer capture.

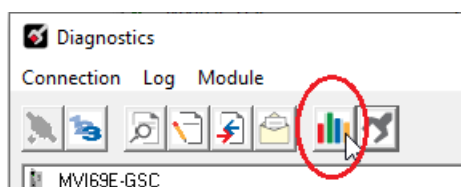

- Each byte will be enclosed with < > for data transferred out of the port, and [] for data received on the port.

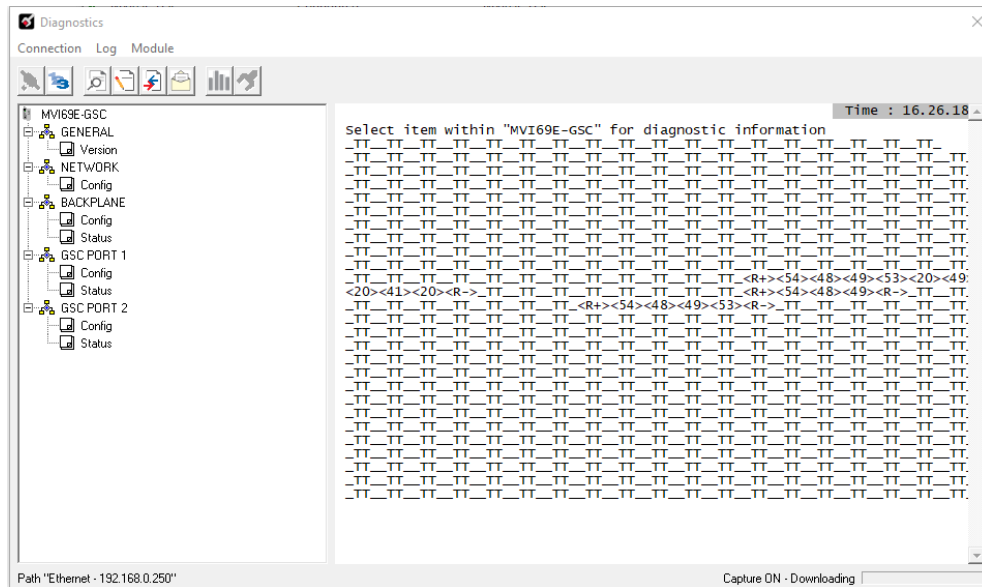

- Click on the same **DATA ANALYZER** button to stop the data analyzer operation:

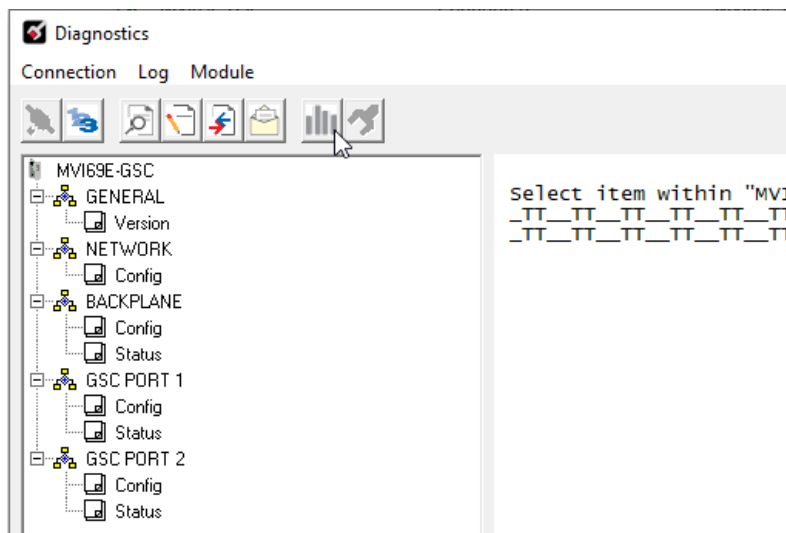

- You may also log the data analyzer capture to a text file. Click on the following **START LOG** button to log the data analyzer capture:

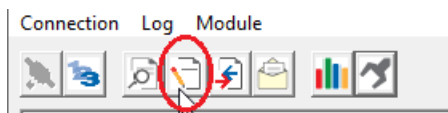

8 Click on the same **LOG** button to stop the data capture logging:

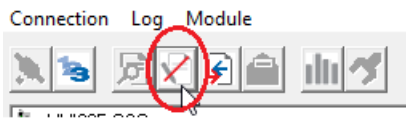

9 Click on the **VIEW LOG FILE** button to view the log file:

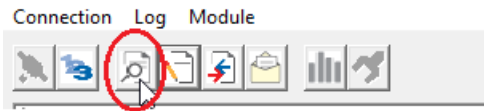

10 The log file opens in Notepad

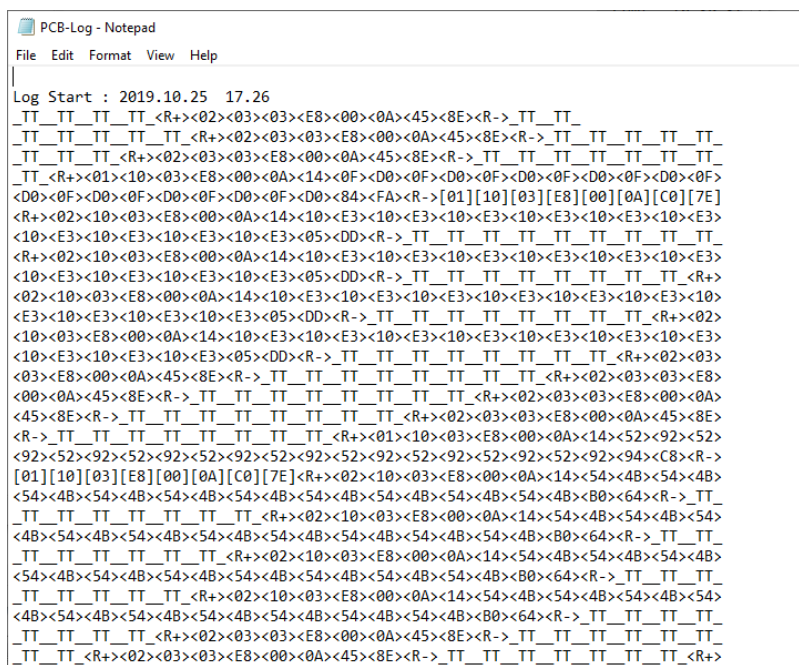

11 To clear the log file before a new logging session starts, click the **CLEAR LOG FILE** button.

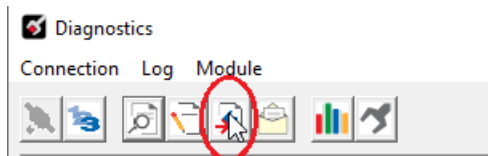

7.7 Connecting to the Module's Webpage

The module's internal web server provides access to module version and status information, as well as the ability to set the date and time, reboot the module, and download firmware upgrade to the module. Enter the assigned IP address of the module into a web browser or use the following steps in PCB.

- 1 In the PCB Diagnostics window, click the **SET UP CONNECTION** button.



Click to set up connection

- 2 In the *Connection Setup* dialog box, click **BROWSE DEVICE(S)** to start *ProSoft Discovery Service*.
- 3 Right-click the module icon and choose **VIEW MODULE'S WEBPAGE** to launch your default browser and display the module's webpage.

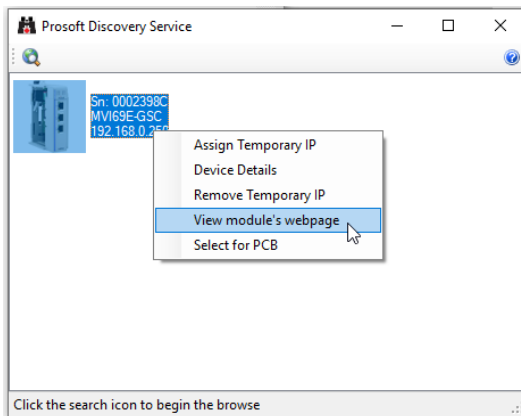

ProSoft TECHNOLOGY

FUNCTIONS

- ▶ Firmware Upgrade
- ▶ Set Date & Time
- ▶ Reboot Module
- ▶ Technical Support
- ▶ Homepage

Generic Serial Module for CompactLogix
MVI69E-GSC

Module Name	MVI69E-GSC
Ethernet Address (MAC)	00:0D:8D:03:29:8C
IP Address	192.168.0.250
Product Revision	2.01.001 2.6.33.7 #11
Firmware Version Date	07/11/19 - 01
Serial Number	0002398C
Status	Running
Uptime	04:54:39

RESOURCES

ProSoft Technology

8 Reference

8.1 Product Specifications

The MVI69E-GSC allows Rockwell Automation® CompactLogix or MicroLogix 1500-LRP® I/O compatible processors to interface easily with other ASCII protocol compatible devices.

The module acts as an input/output communications module between the ASCII network and the CompactLogix or MicroLogix 1500-LRP backplane. The data transfer from the CompactLogix or MicroLogix 1500-LRP processor is asynchronous from the actions on the Modbus network. Databases are user-defined and stored in the module to hold the data required by the protocol.

- Single-slot, 1769 backplane-compatible
- The module is recognized as an Input/Output module and has access to processor memory for data transfer between processor and module.
- Ladder Logic is used for data transfer between module and processor. Sample Add-On Instruction file included.
- Configuration data obtained from and stored in the module
- Supports CompactLogix or MicroLogix 1500-LRP processors with 1769 I/O bus capability and at least 500 mA of 5 VDC backplane current available.

8.1.1 Hardware Specifications

Specification	Description
Dimensions	Standard 1769 Single-slot module
Current Load	500 mA max @ 5 VDC Power supply distance rating of 4 (L43 and L45 installations on first 4 slots of 1769 bus)
Operating Temp.	32° F to 140° F (0° C to 60°C)
Storage Temp.	-40° F to 185° F (-40° C to 85° C)
Relative Humidity	5% to 95% (with no condensation)
LED Indicators	Module OK Status Backplane Activity Ethernet Port Activity Configuration Activity Serial port Activity
CFG Port (ETH)	Diagnostics over Ethernet connection
App Ports (P1,P2)	RS-232, RS-485 or RS-422 (jumper selectable) RJ45 Port (DB-9F with supplied cable) 500V Optical isolation from backplane
Shipped with Unit	RJ45 to DB-9M cables for each application port

8.1.2 Functional Specifications

- ASCII Communication ports 1 & 2 (PRT1, PRT2)
 - Both ports are capable of transmitting and/or receiving ASCII character strings. Each port is individually configurable:
 - Termination types
 - Stream mode
 - Termination character(s)
 - Message timeout
 - Intercharacter timeout
 - Packet size limit
 - Baud rate: 110 to 115.2K baud
 - Parity: none, even, odd
 - Stop bits: 1 or 2
 - Data bits: 5 to 8
 - RTS on/off timing: 0 to 65535 milliseconds
 - Minimum response delay: 0 to 65535 milliseconds
- Handshaking (optional)
 - Hardware: RTS/CTS, DTR/DSR
 - Software: XON/XOFF
- ASCII character strings up to 4096 characters in length supported
- Full hardware handshaking control provides radio, modem and multi-drop support
- User-definable module memory usage, supporting the storage and transfer of up to 4000 registers to/from the control processor
- Module error and status conditions returned to processor for diagnostic purposes
 - Module status
 - Port error status word (bit mapped)
 - Port receive state
 - Port receive character count
 - Port receive block count
 - Port transmit state
 - Port transmit character count
 - Port transmit block count
- All data related to the module is contained in a single controller tag with defined objects to simplify configuration, monitoring and interfacing with the module
- Module configuration and communication configuration data is transferred to the module via a predefined user data type in the processor

8.2 Functional Overview

8.2.1 General Concepts

The MVI69E-GSC module uses ladder logic to communicate with the CompactLogix or MicroLogix 1500-LRP processor across the backplane. The ladder logic handles the module data transfer, configuration data transfer, special block handling, and status data receipt.

The following topics describe several concepts that are important for understanding the operation of the MVI69E-GSC module. This is the order of operations on power-up:

- 1 The module begins the following logical functions:
 - Initialize hardware components
 - Initialize CompactLogix or MicroLogix 1500-LRP backplane driver
 - Test and clear all RAM
- 2 Read configuration from the CompactLogix or MicroLogix 1500-LRP processor through ladder logic
- 3 Allocate and initialize Module Register space
- 4 Enable application port(s)

After the module has received the module configuration, the module begins communicating with other devices on the network, depending on the configuration of the module.

8.2.2 Backplane Data Flow

The following topics describe the flow of data between the hardware (CompactLogix processor and MVI69E-GSC module) and other devices on the network under the module's different operating modes.

Backplane Data Transfer

The MVI69E-GSC module communicates directly over the CompactLogix or MicroLogix backplane. Data is paged between the module and the CompactLogix processor across the backplane using the module's input and output images. The update frequency of the images is determined by the scheduled scan rate defined by the user for the module and the communication load on the module. Typical updates are in the range of 2 to 10 milliseconds.

The data is paged between the processor and the module using input and output image blocks (fixed at 60 words).

This bi-directional transference of data is accomplished by the module filling in data in the module's input image to send to the processor. Data in the input image is placed in the Controller Tags in the processor by the ladder logic.

The processor inserts data to the module's output image to transfer to the module. The module's program extracts the data and places it in the module's internal database.

The following illustration shows the data transfer method used to move data between the CompactLogix processor, the MVI69E-GSC module, and the network.

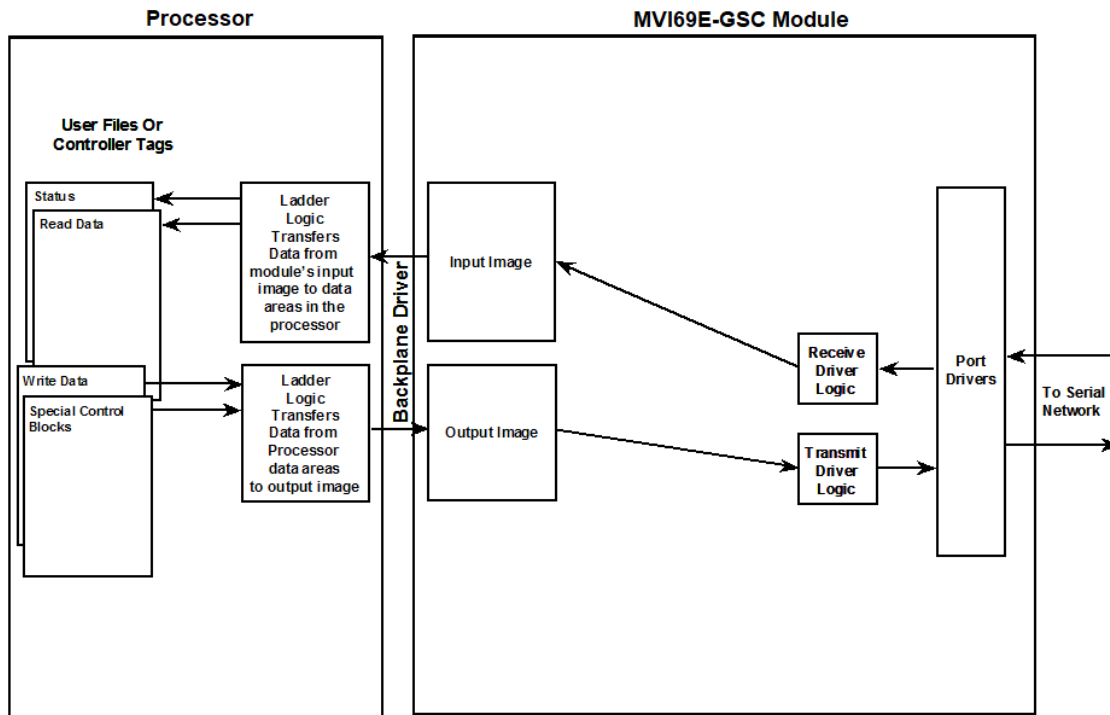

Normal Data Transfer

Normal data transfer includes the paging of the user data to and from the module’s ports and bringing in status data. These data are transferred through read (input image) and write (output image) blocks. The structure and function of each block is discussed in the following topics.

Block Request from the Processor to the Module

These blocks of data are used to transfer information from the CompactLogix processor to the module. The structure of the output image used to transfer this data is shown below:

Port	Word Offset	Description
Port 1	0	Block Sequence Number (Read block number as sent by module) (0 to 127)
	1	Inter-character delay for this message (milliseconds between characters)
	2	Number of characters to transmit on Port 1 (0 to 50)
	3 to 27	Port 1 ASCII character codes to transmit (up to 50 ASCII characters)
Port 2	28	Inter-character delay for this message (milliseconds between characters)
	29	Number of characters to transmit on Port 2 (0 to 50)
	30 to 54	Port 2 ASCII character codes to transmit (up to 50 ASCII characters)
	55 to 59	Reserved

The Block Sequence Number is that received on the last read block transfer through the input image on the module. The ladder logic should copy this value from byte 0 of the input image to byte 0 of output image in the ladder logic. This must be the last operation performed when constructing the write block. The module's program will trigger the process write block function when a new value is recognized in byte 0 of the output image.

If the number of characters to transmit in the write block is not set to zero (non-zero value in bytes 2 and 29), this indicates to the module there is data present in the block that needs to be transmitted. If the selected port is not already busy transmitting data from a previous write block, the data in the block will be moved to the port's transmit buffer and sent out the port as soon as possible.

In order to pace the characters for the write operation, an inter-character delay value is associated with each write message. For devices that do not buffer received data, when interfacing with a modem in command mode or when simulating keyboard or keypad entry, inter-character delays may be required. For example, if the port is tied to a device that expects input with delays of 200 milliseconds between each character, place the data to send in the write block output image along with the length and set the inter-character delay byte (bytes 1 and 28) to a value of 200 in the module's output image in the processor's ladder logic program.

The message will be transmitted with a 200-millisecond wait period between each character. Because this delay value is sent from the processor for each write message, the inter-character delay can be set independently for each message. For example, when writing AT commands to a dial-up modem, an inter-character delay of 100 may be required. But when the modem is in data mode, the inter-character delay can be set to 0. When the delay is set to 0, the whole packet of data will be placed in the module's transmit buffer at one time.

Block Response from the Module to the Processor

These blocks transfer information from the module to the processor. The structure of the input image used to transfer these data is shown below. The Block Sequence Number (byte 0) is an index value used to signal to the processor that a new block is ready for processing. The ladder logic must recognize a change in this value and process the data encapsulated in the input image. The block contains the data received on each port and status data. The two byte values in bytes 1 (port 1 receive length), and 28 (port 2 receive length), hold the number of characters received on each port to be processed by the ladder logic. ASCII character code data received on the ports are found starting at byte 3 and 30 for Port 1 and 2, respectively. The simpler version of the example ladder logic assumes the number of ASCII characters received on each port is less than or equal to fifty characters (25 words per port, times 2 characters per word).

	Word Offset	Description
	0	Block Sequence Number (Bumped each scan by module) (0 to 127)
Port 1	1	Number of characters (0 to 50) in Port 1 receive block (3 to 27). If the string received on the port is larger than 50 characters, multiple blocks will be transferred. Any block with a value of -1 in this field represents the first or continuation block and the block contains 50 characters of ASCII code data. The last block of data will contain a positive number in this field that represents the number of characters in the last block. Status data will be returned in words 3 to 27 if this word contains a value of 0.
	2	Number of characters transmitted (0 to 50) from last block write for Port 1
	3 to 27	Port 1 data received (up to 50 ASCII character codes of data). If the number of characters received for the port is 0, status data will be returned in this area.
Port 2	28	Number of characters (0 to 50) in Port 2 receive block (30 to 54). If the string received on the port is larger than 50 bytes, multiple blocks will be transferred. Any block with a value of -1 in this field represents the first or continuation block and the block contains 50 characters of ASCII code data. The last block of data will contain a positive number in this field that represents the number of characters in the last block. Status data will be returned in words 30 to 54 if this word contains a value of 0.
	29	Number of characters transmitted (0 to 50) from last block write for Port 2
	30 to 54	Port 2 data received (up to 50 ASCII character codes of data). If the number of characters received for the port is 0, status data will be returned in this area
	55 to 59	Reserved

The receive buffer in the module can hold up to 4096 characters. This large size permits the buffering of a large amount of data before a transfer of the data to the controller is required. The module buffers incoming ASCII characters in its receive buffer until one of the user-specified termination conditions is recognized. The module will then transfer the received terminated string to the controller.

The ladder logic required to properly handle transfer of terminated strings longer than 50 characters per port is more complex than the simpler version of ladder logic discussed above. If the terminated string is larger than 50 characters, multiple blocks will be used to transfer the data to the controller. The first block will contain a value of -1 in the "Number of Characters Received" data field. This indicates that there will be more blocks to follow and that the current block contains 50 ASCII character codes. As long as more than 50 characters remain in the buffer waiting to be sent to the ladder logic, successive Read Blocks will continue to show the "Number of Characters Received" as -1. When 50 or fewer ASCII characters remain in the buffer, the module will send the last block with a positive number in the length field. The value passed represents the number of characters present in the data area, which is the last characters of the complete, terminated string. The ladder logic must recognize the presence of one or more successive blocks with -1 lengths and then the positive number of the last block as indication that a single, complete, long string has been completely transferred.

The two byte values at bytes 1 (port 1 transmit count) and 29 (port 2 transmit count) inform the processor of the number of ASCII characters transferred in the last write block to the respective port transmit buffers. If a value of zero is returned in one of these words and data was sent in the last write block, the ladder logic must re-send the data in the next write block because the port was in a busy state and could not transmit the last data to be written at the time the Write Block was received by the module from the ladder logic. If a non-zero value is returned in one of these bytes, the value represents the number of ASCII characters from the last write block that were successfully moved into the port's transmit buffer.

The status information transferred in the read block can be used by the processor to determine the state and "health" of the module and the device(s) attached to each application port. An important member of the value in the status object is error word for each port. This value contains the configuration error flags for each port and the receive buffer overflow error flag.

8.2.3 Special Function Blocks

Special Function blocks are blocks used to control the module or request special data from the module. The current version of the software supports two Special Functions, warm boot and cold boot.

Warm Boot Block (9998)

This block is sent from the CompactLogix or MicroLogix processor to the module (output image) when the module is required to perform a warm-boot (software reset) operation. The following table describes the format of the control block.

Offset	Description	Length
0	9998	1
1	Spare	

Cold Boot Block (9999)

This block is sent from the CompactLogix or MicroLogix processor to the module (output image) when the module is required to perform the cold boot (hardware reset) operation. This block is sent to the module when a hardware problem is detected by the ladder logic that requires a hardware reset. The following table describes the format of the control block.

Offset	Description	Length
0	9999	1
1	Spare	

8.3 Ethernet Port Connection

8.3.1 Ethernet Cable Specifications

The recommended cable is Category 5 or better. A Category 5 cable has four twisted pairs of wires, which are color-coded and cannot be swapped. The module uses only two of the four pairs.

The Ethernet port or ports on the module are Auto-Sensing. You can use either a standard Ethernet straight-through cable or a crossover cable when connecting the module to an Ethernet hub, a 10/100 Base-T Ethernet switch, or directly to a PC. The module detects the cable type and uses the appropriate pins to send and receive Ethernet signals.

Some hubs have one input that can accept either a straight-through or crossover cable, depending on a switch position. In this case, you must ensure that the switch position and cable type agree.

Refer to Ethernet Cable Configuration (page 71) for a diagram of how to configure Ethernet cable.

Ethernet Cable Configuration

Note: The standard connector view shown is color-coded for a straight-through cable.

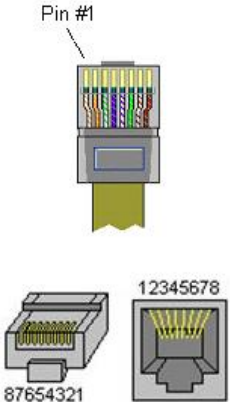
Crossover cable			Straight- through cable	
RJ-45 PIN	RJ-45 PIN		RJ-45 PIN	RJ-45 PIN
1 Rx+	3 Tx+		1 Rx+	1 Tx+
2 Rx-	6 Tx-		2 Rx-	2 Tx-
3 Tx+	1 Rx+		3 Tx+	3 Rx+
6 Tx-	2 Rx-		6 Tx-	6 Rx-

Ethernet Performance

Ethernet performance in the MVI69E-GSC module can be affected in the following way:

- Accessing the web interface (refreshing the page, downloading files, and so on) may affect performance
- Also, high Ethernet traffic may impact module performance, so consider one of these options:
 - Use managed switches to reduce traffic coming to module port
 - Use CIPconnect for these applications and disconnect the module Ethernet port from the network

8.4 Application Port Cable Connection

The application ports on the MVI69E-GSC module support RS-232, RS-422, and RS-485 interfaces. Please inspect the module to ensure that the jumpers are set correctly to correspond with the type of interface you are using.

Note: When using RS-232 with radio modem applications, some radios or modems require hardware handshaking (control and monitoring of modem signal lines). Enable this in the configuration of the module by setting the UseCTS parameter to 1.

8.4.1 RS-232 Wiring

When the RS-232 interface is selected, the use of hardware handshaking (control and monitoring of modem signal lines) is user definable. If no hardware handshaking is used, here are the cable pin-outs to connect to the port.

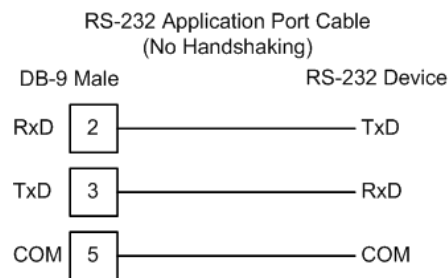

RS-232: Modem Connection (Hardware Handshaking Required)

This type of connection is required between the module and a modem or other communication device.

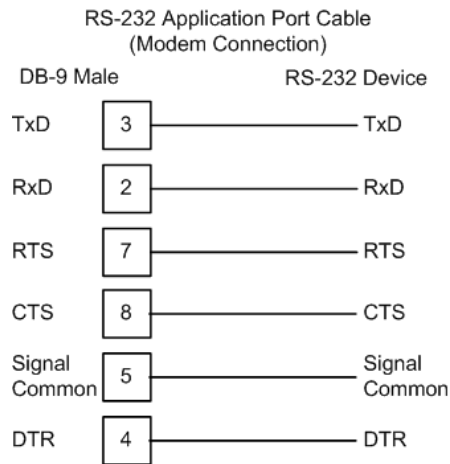

The "Use CTS Line" parameter for the port configuration should be set to 'Y' for most modem applications.

RS-232: Null Modem Connection (Hardware Handshaking)

This type of connection is used when the device connected to the module requires hardware handshaking (control and monitoring of modem signal lines).

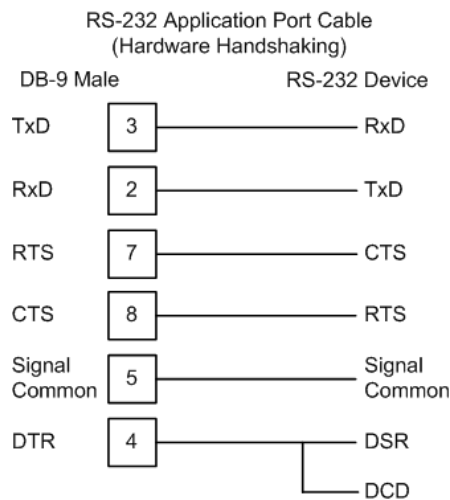

RS-232: Null Modem Connection (No Hardware Handshaking)

This type of connection can be used to connect the module to a computer or field device communication port.

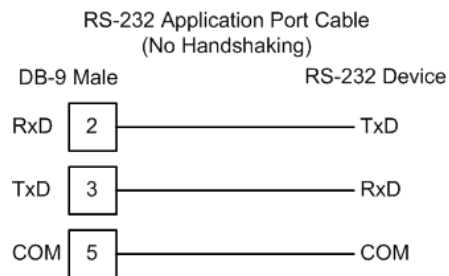

Note: For most null modem connections where hardware handshaking is not required, the *Use CTS Line* parameter should be set to **N** and no jumper is required between Pins 7 (RTS) and 8 (CTS) on the connector. If the port is configured with the *Use CTS Line* set to **Y**, then a jumper is required between the RTS and the CTS lines on the port connection.

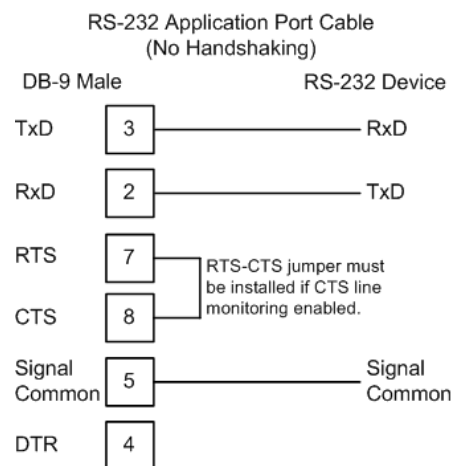

8.4.2 RS-422 Wiring

The RS-422 interface requires a single four or five wire cable. The Common connection is optional, depending on the RS-422 network devices used. The cable required for this interface is shown below:

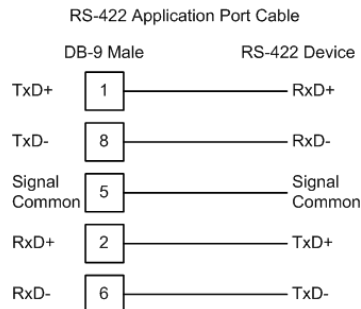

8.4.3 RS-485 Wiring

The RS-485 interface requires a single two or three wire cable. The Common connection is optional, depending on the RS-485 network devices used. The cable required for this interface is shown below:

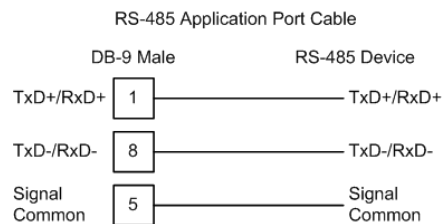

Note: This type of connection is commonly called a RS-485 half-duplex, 2-wire connection. If you have RS-485 4-wire, full-duplex devices, they can be connected to the gateway's serial ports by wiring together the TxD+ and RxD+ from the two pins of the full-duplex device to Pin 1 on the gateway and wiring together the TxD- and RxD- from the two pins of the full-duplex device to Pin 8 on the gateway. As an alternative, you could try setting the gateway to use the RS-422 interface and connect the full-duplex device according to the RS-422 wiring diagram. For additional assistance, please contact ProSoft Technical Support.

Note: Depending upon devices on the network, if there are problems in RS-485 communication that can be attributed to the signal echoes or reflections, then consider adding 120 OHM terminating resistors at both ends of the RS-485 line.

RS-485 and RS-422 Tip

If communication in the RS-422 or RS-485 mode does not work at first, despite all attempts, try switching termination polarities. Some manufacturers interpret + and -, or A and B, polarities differently.

8.4.4 DB9 to RJ45 Adaptor (Cable 14)

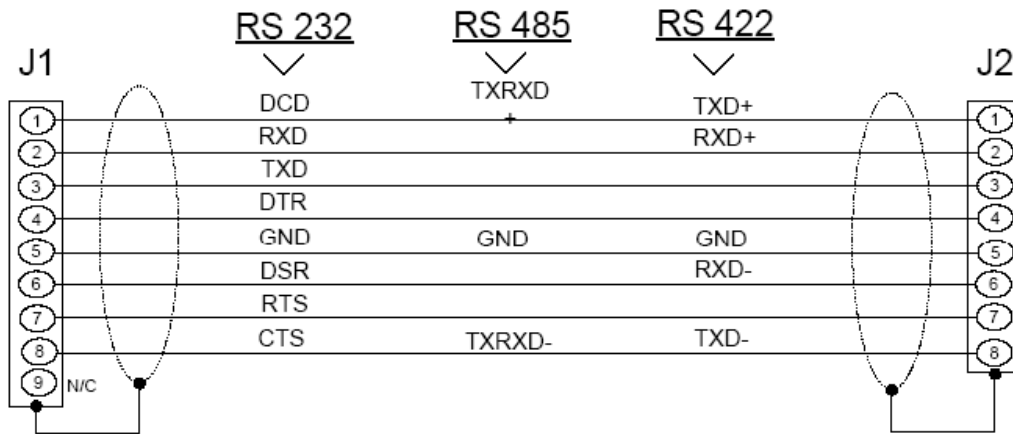
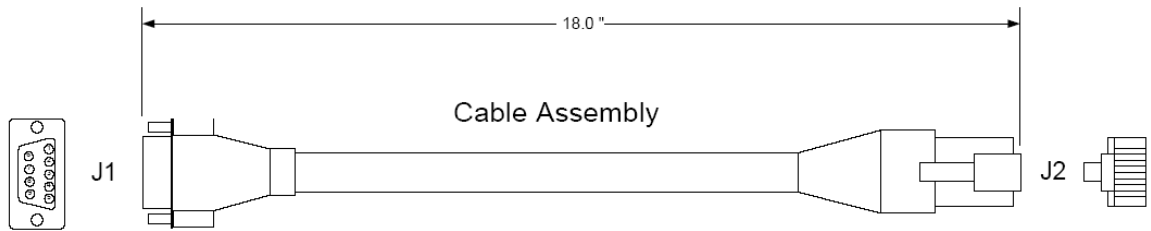

Wiring Diagram

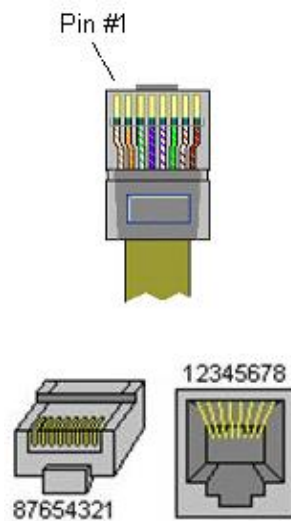

8.5 Status Data Definition

This section contains a description of the members present in the **GSCStatus** object. This data is transferred from the module to the processor as part of each read block.

Object in GSCInStat	Block Offset	Description
PassCnt	3	Program cycle counter
Product	4 to 5	Product name as ASCII string
Rev	6 to 7	Revision level as ASCII string
OP	8 to 9	Operating system level as ASCII string
Run	10 to 11	Run number as ASCII string
BlkErrs.Read	12	Number of blocks transferred from module to processor
BlkErrs.Write	13	Number of blocks transferred from processor to module
BlkErrs.Parse	14	Number of blocks parsed by module
BlkErrs.Err	15	Number of block errors in module
Port1.RxState	16	Port 1 receive state: -1 = Listening for data 1 = Receiving Port Data 2 = Waiting for Backplane transfer
Port1.RXCharCnt	17	Port 1 receive character count
Port1.RxMsgCnt	18	Port 1 receive block count
Port1.TxState	19	Port 1 transmit state: 0 = Waiting for Data to Send 1 = RTS On 2 = RTS Timeout 3 = Sending data 4 = Waiting for RTS Off 5 = RTS turned off 30 = Intercharacter Delay 31 = Intercharacter Delay 32 = Intercharacter Delay 100 = Message Delay before Transmit 101 = Message Delay before Transmit
Port1.TxCharCnt	20	Port 1 transmit character count
Port1.TxMsgCnt	21	Port 1 transmit block count
Port1.ErrorWord	22	Port 1 error word
Port2.RxState	30	Port 2 receive state: -1 = Listening for data 1 = Receiving Port Data 2 = Waiting for Backplane transfer
Port2.RXCharCnt	31	Port 2 receive character count
Port2.RxMsgCnt	32	Port 2 receive block count
Port2.TxState	33	Port 2 transmit state: 0 = Waiting for Data to Send 1 = RTS On 2 = RTS Timeout 3 = Sending data 4 = Waiting for RTS Off 5 = RTS turned off 30 = Intercharacter Delay 31 = Intercharacter Delay 32 = Intercharacter Delay 100 = Message Delay before Transmit 101 = Message Delay before Transmit

Object in GSCInStat	Block Offset	Description
Port2.TxCharCnt	34	Port 2 transmit character count
Port2.TxMsgCnt	35	Port 2 transmit block count
Port2.ErrorWord	36	Port 2 error word

GSCErrWord Definition

Member Name	Bit in Word	Description
Cfg_type	Bit 0	The termination type configured for the port is not valid. Values between 0 and 15 are the only ones valid. The module will use type 0 (stream mode) for the port.
Cfg_Baud	Bit 1	The baud rate entered for the port is not valid. The module will use 9600 baud for the port.
Cfg_Parity	Bit 2	The parity value entered is not valid. Values between 0 and 4 are accepted. The module has set the parity to a value of none (0).
Cfg_DataBits	Bit 3	The number of data bits for the protocol is not valid. Values between 5 and 8 are accepted. The module assumes a value of 8 data bits.
Cfg_StopBits	Bit 4	The number of stop bits for the protocol is not valid. Values of 1 or 2 are accepted. The module assumes a value of 1 stop bit.
Cfg_Handshake	Bit 5	The handshake code for the port is not valid. The value entered must be in the range of 0 to 3. The module assumes a value of 0 (no handshaking).
Cfg_Rtermcount	Bit 6	The number of termination characters is not valid. The value must be set between 1 and 12 when using the termination character string to end a receive buffer. The module will not terminate a buffer when using the termination character(s) when this bit is set.
Cfg_RPacketLen	Bit 7	The number of characters for a packet is not valid. The value must be set between 1 and 4096 when the packet size termination option is used. The module will not use the packet length termination option when this bit is set.
Cfg_Rtimeout	Bit 8	The message timeout value is set to zero. The module will not use the message timeout termination option when this bit is set.
Cfg_Rdelay	Bit 9	The intercharacter delay value configured is set to zero. The module will not use the intercharacter delay option when this bit is set.
Cfg_Wtimeout	Bit 10	The write message timeout parameter is set to zero. The module assumes a value of 5000 milliseconds.
	Bit 11	
	Bit 12	
	Bit 13	
	Bit 14	
Err_ROverflow	Bit 15	Data is being received faster on the port than the ladder logic can process the read blocks. Alter the configuration of the module or the connected device. Receive data is being lost.

9 Support, Service & Warranty

9.1 Contacting Technical Support

ProSoft Technology, Inc. is committed to providing the most efficient and effective support possible. Before calling, please gather the following information to assist in expediting this process:

- 1 Product Version Number
- 2 System architecture
- 3 Network details

If the issue is hardware related, we will also need information regarding:

- 1 Module configuration and associated ladder files, if any
- 2 Module operation and any unusual behavior
- 3 Configuration/Debug status information
- 4 LED patterns
- 5 Details about the interfaced serial, Ethernet or Fieldbus devices

Note: For technical support calls within the United States, ProSoft Technology's 24/7 after-hours phone support is available for urgent plant-down issues.

North America (Corporate Location)	Europe / Middle East / Africa Regional Office
Phone: +1.661.716.5100 info@prosoft-technology.com Languages spoken: English, Spanish REGIONAL TECH SUPPORT support@prosoft-technology.com	Phone: +33.(0)5.34.36.87.20 france@prosoft-technology.com Languages spoken: French, English REGIONAL TECH SUPPORT support.emea@prosoft-technology.com
Latin America Regional Office	Asia Pacific Regional Office
Phone: +52.222.264.1814 latinam@prosoft-technology.com Languages spoken: Spanish, English REGIONAL TECH SUPPORT support.la@prosoft-technology.com	Phone: +60.3.2247.1898 asiapc@prosoft-technology.com Languages spoken: Bahasa, Chinese, English, Japanese, Korean REGIONAL TECH SUPPORT support.ap@prosoft-technology.com

For additional ProSoft Technology contacts in your area, please visit:
www.prosoft-technology.com/About-Us/Contact-Us.

9.2 Warranty Information

For complete details regarding ProSoft Technology's TERMS & CONDITIONS OF SALE, WARRANTY, SUPPORT, SERVICE AND RETURN MATERIAL AUTHORIZATION INSTRUCTIONS, please see the documents at: www.prosoft-technology.com/legal