



User Guide

Document Rev #: 80-7050-001_K

OleumTech® OTC Wireless Sensor and I/O Network DH2-W Wireless Gateway

Class I, Division 2 (Zone 2)

BM-0900-GM1 | BM-0915-GM1 | BM-2400-GM1 | BM-0868-GM1

www.prosoft-technology.com

1.661.716.5100

Table of Contents

Table of Contents.....	2	26. I/O EXPANSION CAPABILITIES	62
1. SAFETY, CERTIFICATIONS, COMPLIANCE	3	27. I/O MAPPING (MODBUS WRITE FUNCTION AND MAPPING IT TO THE GATEWAY'S OUTPUT)	65
2. PRODUCT OVERVIEW	8	28. MAPPING AN IMPORT POINT TO ANOTHER GATEWAY'S OUTPUT	68
3. HARDWARE OVERVIEW.....	9	29. ROC LINK MASTER	69
4. NETWORKING DIAGRAM.....	10	30. SAVING THE PROJECT FILE TO THE GATEWAY.....	71
5. TECHNICAL SPECIFICATIONS	10	31. RETRIEVING THE PROJECT FILE FROM THE GATEWAY	72
6. ITEMS REQUIRED FOR SETUP	11	32. SITE SECURITY KEY.....	73
7. LED STATES (STATUS INDICATORS)	12	33. TROUBLESHOOTING	75
8. WIRING.....	13	34. GENERAL MAINTENANCE	76
9. GROUNDING RECOMMENDATIONS.....	19	35. WARRANTY (LIMITED)	76
10. INSTALLATION	21	36. REVISION HISTORY	77
11. RF SETUP / RF SECURITY.....	26		
12. DOWNLOAD & INSTALL THE SOFTWARE.....	28		
13. CREATE A PROJECT FILE USING THE SOFTWARE	28		
14. SOFTWARE MAIN SCREEN VIEW	33		
15. EDITING THE GATEWAY PROPERTIES	36		
16. MODBUS MAPPING TABLE MANAGEMENT	38		
17. RF HOST ADDRESS MANAGEMENT	43		
18. HOW TO PROGRAM/UPDATE THE GATEWAY	45		
19. CONNECTING TO THE GATEWAY VIA THE SOFTWARE	47		
20. HOW TO UPGRADE THE GATEWAY FIRMWARE	49		
21. POLLING MODBUS REGISTERS USING THE SOFTWARE	50		
22. DEBUG SESSION	52		
23. RF REFRESH TIME TAG(S)	53		
24. PEER-TO-PEER/REPEATER/SHARING DATA	54		
25. MODBUS MASTER FUNCTION	58		

1. SAFETY, CERTIFICATIONS, COMPLIANCE

1. Safety



CAUTION: Field wiring connections shall be made in accordance with Article 504 of the National Electrical Code, ANSI/NFPA70.

CAUTION: The Gateway must be installed within an enclosure that requires a tool to access. This is to prevent inadvertent disconnection of any of the power wiring, signal wiring or communication cables.

WARNING: Ensure installation of the Gateway meets applicable state and national electrical code requirements. The installation of the Gateway should only be performed by a qualified installer or a factory representative.

WARNING: To prevent ignition of flammable or combustible atmospheres, disconnect power before servicing.

WARNING: EXPLOSION HAZARD – Substitution of components impair suitability for Zone 2.

WARNING: EXPLOSION HAZARD – Do not separate/disconnect connectors when energized.

WARNING: EXPLOSION HAZARD – Do not use USB connectors in hazardous area.

WARNING: EXPLOSION HAZARD – Do not service when an explosive atmosphere is present.

WARNING: EXPLOSION HAZARD – Do not use reset switch in hazardous area.

Note: This equipment is suitable for use in Class I, Division 2 Groups A, B, C, and D or non-hazardous locations only.

Sécurité



ATTENTION: Les connexions de câblage sur site doivent être réalisées conformément à l'article 504 du Code national de l'électricité, ANSI / NFPA70.

ATTENTION: Le Gateway doit être installé dans une enceinte qui nécessite un outil d'accès. Ce est pour éviter toute déconnexion accidentelle de l'un des câbles câblage de puissance, câblage ou de communication signaux.

AVERTISSEMENT: Veiller à l'installation de la passerelle répond Etat et des exigences nationales de code de l'électricité. L'installation de la Gateway ne doit être effectuée par un installateur qualifié ou un représentant de l'usine.

AVERTISSEMENT: Pour éviter l'inflammation d'atmosphères inflammables ou combustibles, débrancher l'alimentation avant l'entretien.

AVERTISSEMENT: RISQUE D'EXPLOSION - Le remplacement de composants nuire à la conformité pour la Zone 2.

AVERTISSEMENT: RISQUE D'EXPLOSION - Ne pas séparer / débrancher les connecteurs lorsque excité.

AVERTISSEMENT: RISQUE D'EXPLOSION - Ne pas utiliser les connecteurs USB en zone dangereuse.

AVERTISSEMENT: RISQUE D'EXPLOSION - Ne pas service lorsque une atmosphère explosive est présente.

AVERTISSEMENT: RISQUE D'EXPLOSION - Ne pas utiliser le commutateur de réinitialisation en zone dangereuse.

Remarque: Cet équipement est conçu pour être utilisé uniquement dans les zones non dangereuses de Classe I, Division 2, Groupes A, B, C et D.

2. Certifications

EMC/EMI



- FCC Part 15 (USA)
- IC ICES-003 (Canada)



- AS/NZS CISPR 32 Class A
- AS/NZS 4268:2017

SAFETY



- Class I, Division 2, Groups A, B, C, D T4; Ex nA IIC T4 Gc
- Class I, Zone 2 AEx nA IIC T4 Gc



- 9-30 Vdc, Ta = -40 °C to +80 °C (-40 °F to 176 °F)
- ATEX: Sira 15ATEX4134X; Ex nA IIC T4 Gc, II 3 G
- IECEx: SIR 15.0055X; Ex nA IIC T4 Gc



- 9-30 Vdc, Ta = -40 °C to +80 °C (-40 °F to 176 °F)

3. Specific Conditions of Safe Use

- a. All modules are to be used with accessory Data Rail, part number BS-010-BK, rated 150 V max, Ta = -40 °C to 80 °C.
- b. This is OPEN type equipment that must be installed within a suitable end-use enclosure that requires a tool to access, and is appropriately certified (e.g. Ex e, Ex nA, Ex d, Ex p, or equivalent protection), providing a minimum ingress protection level of IP54. The suitability of the enclosure is subject to investigation by local Authority having jurisdiction at the time of installation.
- c. The USB connector shall not be used in normal operation. It is intended for temporary configuration, programming, and diagnostic use during installation and shall not be used unless the area is known to be nonhazardous.
- d. Assessment of the antenna and its wiring is not part of the certificate.
- e. External transient overvoltage protection must be provided in the power supplied to the equipment at a level not exceeding 140% of the rated voltage at the power supply terminals of the apparatus.

4. EMC/EMI

- a. Important Information to the User
 - This device MUST be professionally installed only by a factory representative or a trained authorized technician.
 - Changes or modifications not expressly approved by the manufacturer may void the user's authority to operate the equipment.
 - This device complies with Part 15 of the FCC Rules. Operation is subject to the following two conditions: 1) this device may not cause harmful interference, and 2) this device must accept any interference received, including interference that may cause undesired operation.
 - This product contains a FHSS (Frequency Hopping Spread Spectrum) and FSK (Frequency Shifting Key) modulation RF transceiver for the 902-928 MHz ISM band, designed to meet FCC 15.247, and is used in industrial control and monitoring applications.
 - To reduce potential radio interference to other users, install and use only the antenna supplied by the manufacturer to ensure successful communications.
 - The antenna is factory sealed and MUST NOT be modified by the user.

b. Compliances**i. FCC RF Exposure**

To comply with FCC RF exposure [compliance](#) requirements, a separation distance of at least 20 cm must be maintained between the antenna of this device and all persons.

ii. FCC Compliance Statement

This equipment has been tested and found to comply with the limits for a class B digital device, pursuant to Part 15 of the FCC Rules. These limits are designed to provide reasonable protection against harmful interference in a residential installation. This equipment generates, uses and can radiate radio frequency energy and if not installed and used in accordance with the instructions, may cause harmful communications to radio communications. However, there is no guarantee that interference will not occur in a particular installation. If this equipment does cause harmful interference to radio or television reception, which can be determined by turning the equipment off and on, the user is encouraged to try to correct the interference by one of the following measures:

- Reorient or relocate the antenna.
- Increase the separation between the equipment and receiver.
- Consult the manufacturer for technical help.

This equipment has been certified to comply with the limits for a class B computing device, pursuant to FCC Rules. In order to maintain compliance with FCC regulations, shielded cables must be used with this equipment. Operation with non-approved equipment or use of unshielded cables is likely to result in interference to radio and television reception. The user is cautioned that changes or modifications made to the equipment without the approval of the manufacturer could void the user's authority to operate this equipment.

c. Australia

The operator does not require a specific license issued by ACMA to operate this equipment. This equipment has been set up by the manufacturer to meet the technical requirements of Class License and should be so maintained.

The device shall be installed in such manner that no member of the general public can be closer than 20cm (0.2 m) from the antenna.

Conformité

Informations importantes à l'utilisateur

- Ce dispositif doit être installé par un professionnel que par un représentant de l'usine ou par un technicien formé et autorisé.
- Les changements ou modifications non expressément approuvés par le fabricant peuvent annuler l'autorité de l'utilisateur à utiliser l'équipement.
- Cet appareil est conforme à la partie 15 des règles de la FCC. Son fonctionnement est soumis aux deux conditions suivantes: 1) ce dispositif ne doit pas causer d'interférences nuisibles et 2) cet appareil doit accepter toute interférence reçue, y compris les interférences qui peuvent causer un mauvais fonctionnement.
- Ce produit contient un FHSS (Frequency Hopping Spread Spectrum) émetteur-récepteur RF pour la bande ISM 902-928 MHz en utilisant FSK (Frequency Shifting Key) modulation, conçu pour répondre FCC 15.247, et est utilisé dans le contrôle industriel et les applications de surveillance.
- Pour réduire les interférences radio potentielles aux autres utilisateurs, installer et utiliser uniquement l'antenne fournie par le fabricant pour assurer une communication réussie.
- L'antenne est scellé en usine et ne doit être modifié par l'utilisateur.

Exposition RF de la FCC

Pour se conformer à la FCC exigences de conformité de l'exposition, une distance de séparation d'au moins 20 cm doit être maintenue entre l'antenne de cet appareil et toutes les personnes.

Déclaration de Conformité FCC

Cet équipement a été testé et déclaré conforme aux limites d'un appareil numérique de classe B, conformément à la partie 15 des règles de la FCC. Ces limites sont conçues pour fournir une protection raisonnable contre les interférences nuisibles dans une installation résidentielle. Cet équipement génère, utilise et peut émettre de l'énergie radiofréquence et, si non installé et utilisé conformément aux instructions, peut provoquer des communications nuisibles aux communications radio. Cependant, il ne est pas garanti que des interférences ne se produiront pas dans une installation particulière. Si cet équipement provoque des interférences nuisibles à la réception radio ou de télévision, ce qui peut être déterminé en mettant l'équipement hors et sous tension, l'utilisateur est encouragé à essayer de corriger l'interférence par une des mesures suivantes:

- Réorienter ou déplacer l'antenne.
- Augmenter la distance entre l'équipement et le récepteur.
- Consultez le fabricant de l'aide technique.

Cet équipement a été certifié conforme aux limites d'un dispositif informatique de classe B, conformément aux règles de la FCC. Afin de maintenir la conformité aux règlements de la FCC, des câbles blindés doivent être utilisés avec cet équipement. L'utilisation d'équipement ou l'utilisation de câbles non blindés non approuvé est susceptible d'entraîner des interférences dans la réception radio et télévision. L'utilisateur est averti que les changements ou modifications apportées à l'équipement sans l'approbation du fabricant pourraient annuler l'autorité de l'utilisateur à utiliser cet équipement.

2. PRODUCT OVERVIEW

Primary Data Collection Point

The OleumTech® DH2-W Wireless Gateway plays an integral role in the OTC Wireless Sensor and I/O Network. It possesses the ability to aggregate data from OTC wireless transmitters and I/O modules onto its 1920-point register holding table. Third-party devices can access the data over the Modbus or LevelMaster ASCII protocol.

Peer-to-Peer Advanced Networking

Deploy multiple gateways to the OTC platform, creating a custom, highly scalable network. The gateways have the ability to communicate with one another. Leverage the peer-to-peer technology and funnel data to the primary gateway, optimizing network efficiency and/or designing an extremely flexible I/O mapping system across the entire wireless network.

Compact and Versatile

The DH2-W is a full-function gateway and is ideal for fitment where enclosure space is a premium. When it is deployed alone, it can be installed on a DIN rail having less than 1" width of space. The DH2-W can be configured as a Modbus Master or Slave device and provides Serial RS232/RS485 connectivity.

Modular Wireless I/O Expansion Solution

The DH2-W can be integrated with OleumTech's isolated 0-10 Vdc, 4-20 mA, and Digital I/O Expansion Modules for solving various I/O challenges. The I/O Modules can be used in any mix or combination with the DH2-W. The BreeZ® Software makes it extremely easy to add and configure I/O points. A standard 35 mm DIN rail is required for I/O Expansion Module(s) integration.

Highlights

- Wirelessly gather/distribute sensor data
- Map I/O points anywhere within the network
- Point-to-multipoint, peer-to-peer connectivity
- Modbus Master/Slave functionality
- Serial/RTU interface (RS232/RS485)
- Integrate OleumTech I/O Expansion Modules without sacrificing its Serial port
- Compact form factor
- -40 °C to 80 °C (-40 °F to 176 °F)
- 900 MHz / 915 MHz / 2.4 GHz / 868 MHz
- Secure AES encryption
- Class I, Division 2 (Zone 2) certified

3. HARDWARE OVERVIEW

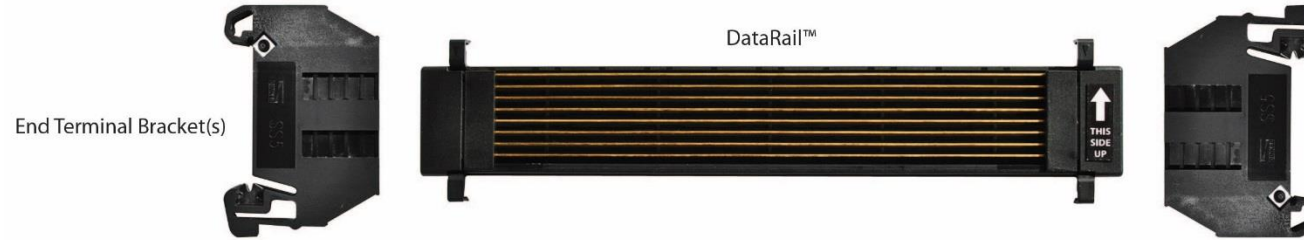
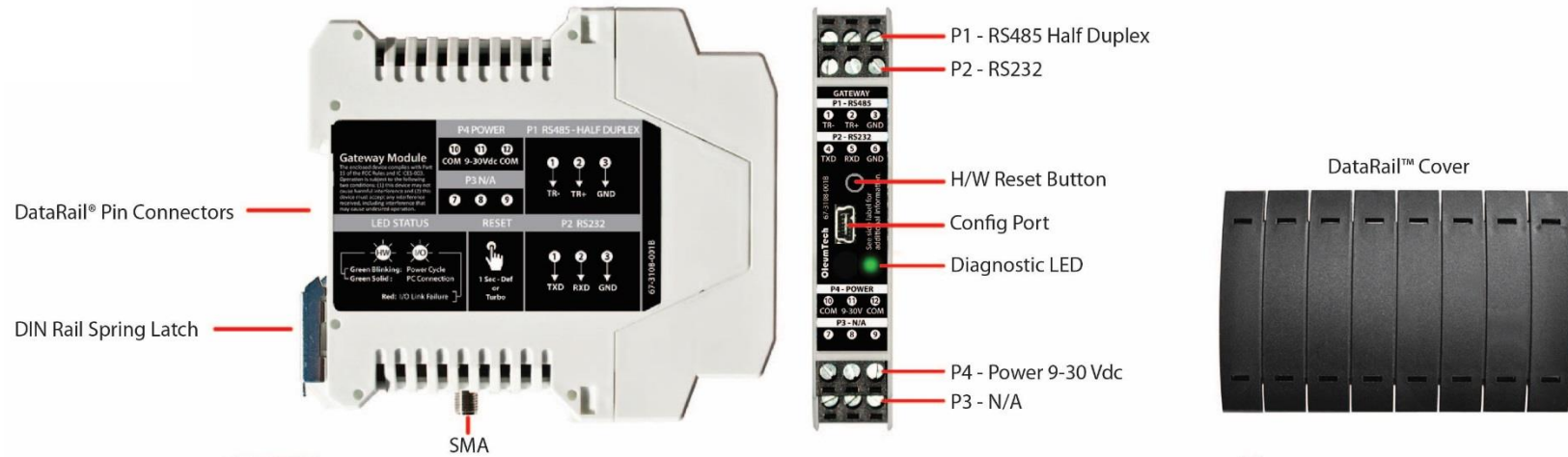

Digital I/O Module



4-20 mA I/O Module



0-10V I/O Module

4. NETWORKING DIAGRAM

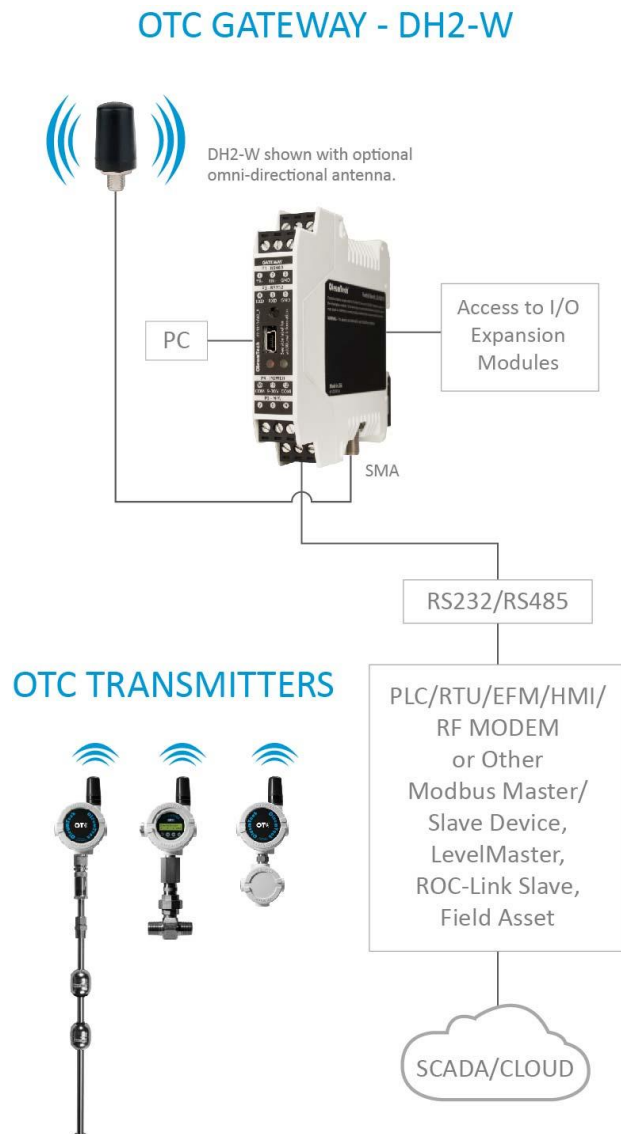

5. TECHNICAL SPECIFICATIONS

[Download Full Datasheet/Technical Specifications](#)

HARDWARE FEATURES	
Device Functionality	· Serial Wireless Gateway with I/O Expansion Capabilities
Embedded Controller	· 32-bit Low Power ARM7 Microcontroller with Internal FLASH (Field Upgradeable)
Serial Interfaces	· RTU Port (RS232/RS485) Terminal Block
	· Modbus Master/Slave, LevelMaster ASCII Slave, ROC-Link Master (Supports Opcodes 17 and 10)
Configuration	· Config / Debug Port - RS232 Slave Only (Mini-USB) / BreeZ® Software for PC
Device Diagnostics	· Health Tag: Supply Voltage
WIRELESS COMMUNICATIONS	
Radio Band	· ISM Band (License-Free)
900 MHz / 915 MHz	· FHSS, FSK, AES Encryption 256-bit (900 MHz), 128-bit (915 MHz)
2.4 GHz	· DSSS, AES Encryption 128-bit
868 MHz	· LBT-AFA, AES Encryption 128-bit
Bit Rate	· 900/915 MHz: 9600 bps / 115.2 kbps; 2.4 GHz: 250 kbps; 868 MHz: 80 kbps
Output Power (Max)	· 900/915 MHz: 1000 mW; 2.4 GHz: 63 mW; 868 MHz: 25mW
Receiving Sensitivity	· 900/915 MHz: -110 dBm @ 9600 bps, -100 dBm @ 115.2 kbps
	· 2.4 GHz: -101 dBm @ 250 kbps; 868 MHz: -106 dBm @ 80 kbps
RF Range	· 900/915 MHz: Up to 40 Miles / 64 km with Clear Line of Sight ¹ (Gateway-to-Gateway)
	· 900/915 MHz: Up to 7500 Feet / 1.4 Miles / 2.3 km with Clear Line of Sight ¹ (Transmitter-to-Gateway)
	· 2.4 GHz: Up to 4.3 Miles / 7 km with Clear Line of Sight ¹
	· 868 MHz: Up to 5.2 Miles / 8.4 km with Clear Line of Sight ¹
SOFTWARE USER INTERFACE (PC APPLICATION)	
Version/PC Platform	· BreeZ® Software v6.0 or Later; PC with Windows® 7 or Later
CERTIFICATIONS & COMPLIANCE	
EMC/EMI	   · FCC Part 15 (USA), IC ICES-003 (Canada), ACMA (Australia)
	· AS/NZS CISPR 32 (Australia), EN55032 & EN55024 (EU)
Safety	   · Class I, Division 2, Groups A, B, C, D T4; Ex nA IIC T4 Gc
	· Class I Zone 2 AEx nA IIC T4 Gc
	    · ATEX: Sira 15ATEX4134X; Ex nA IIC T4 Gc, II 3 G
	· IECEx: SIR 15.0055X; Ex nA IIC T4 Gc
MECHANICAL SPECIFICATIONS	
Dimensions	· 0.7 x 3.9 x 4.5-in / 17.5 x 99 x 114 mm
Package Dimensions	· GM1: 4.8 x 5.1 x 2.8-in / 123 x 129 x 72 mm GM1K: 5.5 x 10.1 x 2.8-in / 140 x 257 x 72 mm
Package Weight	· GM1: 0.5 lbs / 227 g GM1K: ~1 lbs / 0.4 kg
DIN Rail Mounting	· 35 mm x 7.5 mm DIN Rail
I/O Module Support	· Up to 5x I/O Modules using 156 mm DataRail Bus
ELECTRICAL SPECIFICATIONS	
DC Power Input	· 9-30 Vdc
Average Power Input	· 2 Watt
Power Consumption @12 Vdc	· 900/915 MHz @ 1000 mW: Receive Avg 62 mA, Transmit Avg 291 mA
	· 2.4 GHz @ 63 mW: Receive Avg 62 mA, Transmit Avg 109 mA
Power Consumption @24 Vdc	· 868 MHz @ 25 mW: Receive Avg 59 mA, Transmit Avg 75 mA
	· 900/915 MHz @ 1000 mW: Receive Avg 37 mA, Transmit Avg 168 mA
	· 2.4 GHz @ 63 mW: Receive Avg 37 mA, Transmit Avg 62 mA
	· 868 MHz @ 25 mW: Receive Avg 35 mA, Transmit Avg 45 mA
GENERAL SPECIFICATIONS	
Operating Conditions	· Temperature: Class I, Division 2 (Zone 2): -40 °C to 80 °C (-40 °F to 176 °F)
	· Humidity: 0 to 99 %, Non-Condensing
Warranty	· 2-Year Parts and Labor
Country of Origin	· USA

6. ITEMS REQUIRED FOR SETUP

Gateway Setup

- DH2-W Wireless Gateway
- External power source (9-30 Vdc)
- Antenna
- Antenna cable (N to SMA)
- Lightning arrestor and antenna cable (N to N) (recommended)
- External enclosure (NEMA)
- DIN rail (35mm)

I/O Expansion Setup

- DataRail® (Supplied with the Gateway Kit version GM1K)
- 2 End Terminal Brackets (Supplied with GM1K)
- DataRail Covers (Supplied with GM1K)
- Analog 4-20 mA I/O Module (BM-A420-122, sold separately)
- Analog 0-10 V I/O Module (BM-A010-122, sold separately)
- Digital I/O Module (BM-D100-144, sold separately)

Transmitter or I/O Module Setup

- Refer to the specific product User Guide

Configuration Cable

- All-in-One Configuration Cable (SX1000-CC2)

Software and PC

- Latest BreeZ® Configuration Software
- Latest device firmware
- PC with:
 - Microsoft Windows® 7 or later
 - 1 GHz or faster processor
 - 1 GB or more RAM
 - 500 MB Hard Disk Space or more
 - USB or Serial port

Internet Access

- Internet access required for downloading software and firmware
- Access to OleumTech OTC Download Center:
<https://support.oleumtech.com>

Tools

- Technician's screwdriver (flathead)
- Screwdriver set
- Weather-proofing tape

7. LED STATES (STATUS INDICATORS)

#	State	Green LED
1	Booting up	Long blink + 5 short blinks
2	Device On or Off	Off
3	Connected to PC / Updating in Progress / Firmware Upgrade	Solid green
4	Device updated/programmed	Long blink + 5 short blinks
5	Device Failure	Continuous short blinks

When device failure has occurred try following actions:

- Check power source.
- Check that the BreeZ project's radio frequency matches the radio frequency of the DH2-W.
- Call Tech Support.

8. WIRING

1. Serial and Power Wiring



Wiring to or from this equipment, which enters or leaves the system enclosure, must utilize wiring methods suitable for Class I, Division 2 and/or Class I, Zone 2 Hazardous Locations, as appropriate for the installation.

**RS485
HALF
DUPLEX**



RS232



All inputs and outputs on I/O Modules provide field isolation. Please wire accordingly.



Always disconnect power when attaching or detaching I/O Module(s) to or from DataRail to avoid damage.

2. Isolation vs Non-Isolation



If isolation is required, then separate power sources are required for Gateway Module and I/O Module(s).

If isolation is not required, a jumper is required to make common with Radio Module's power supply to to one of I/O Module's COM pin.

Jumper required if using a single power source.

3. 0-10 V I/O Wiring

0-10 V Input and Output Wiring

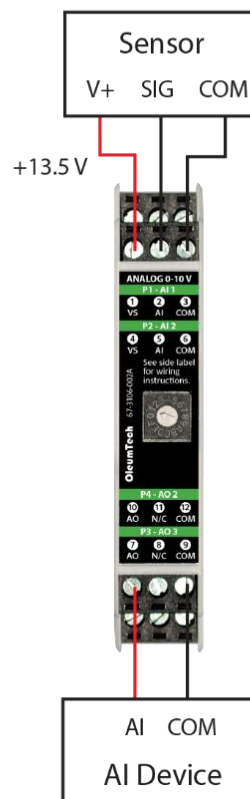

4. 4-20 mA I/O Wiring

4-20 mA Input - Internal Power Loop

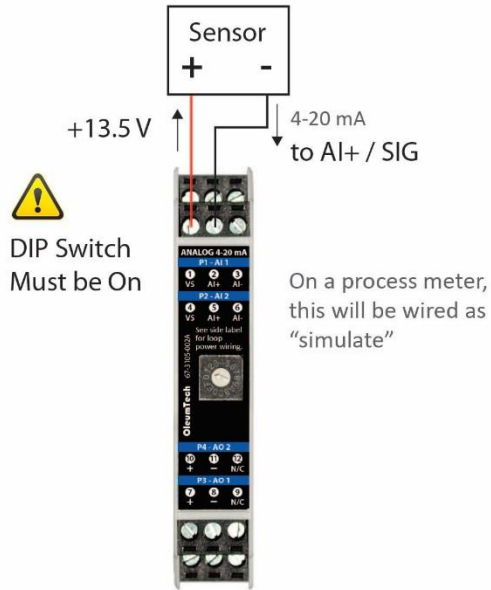

4-20 mA Input - External Power Loop

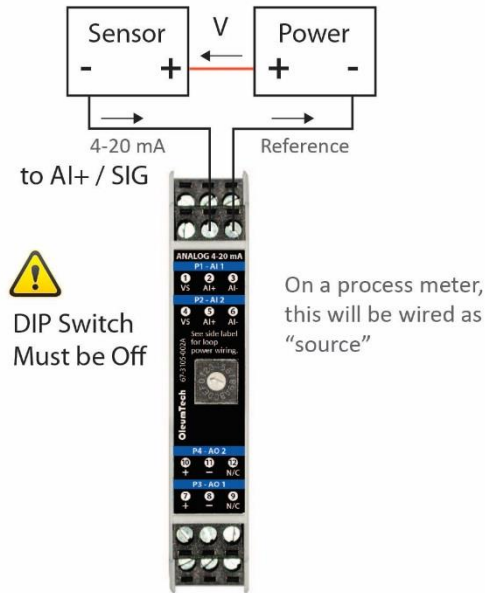

4-20 mA Output

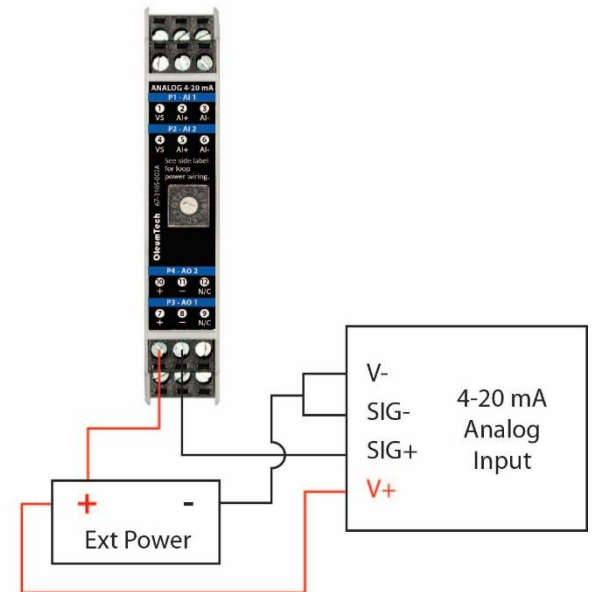

5. Digital Input Wiring

Digital Level Input - Active High

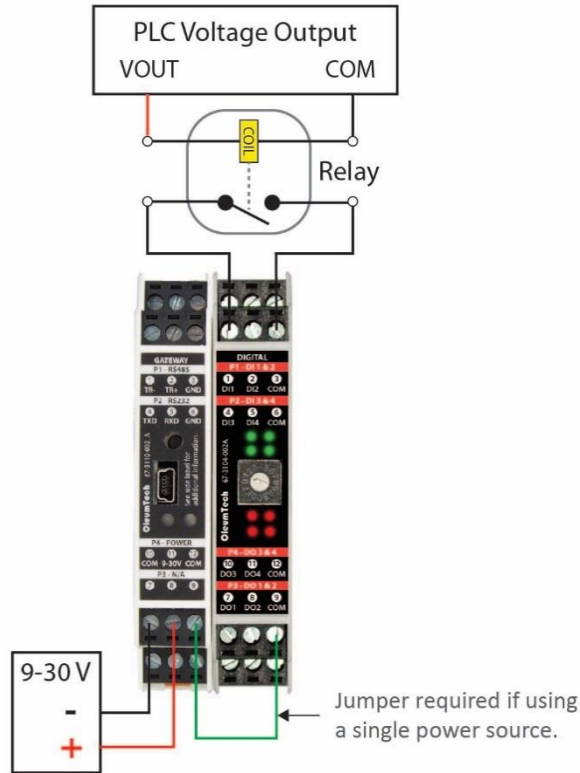

Digital Level Input - Active Low

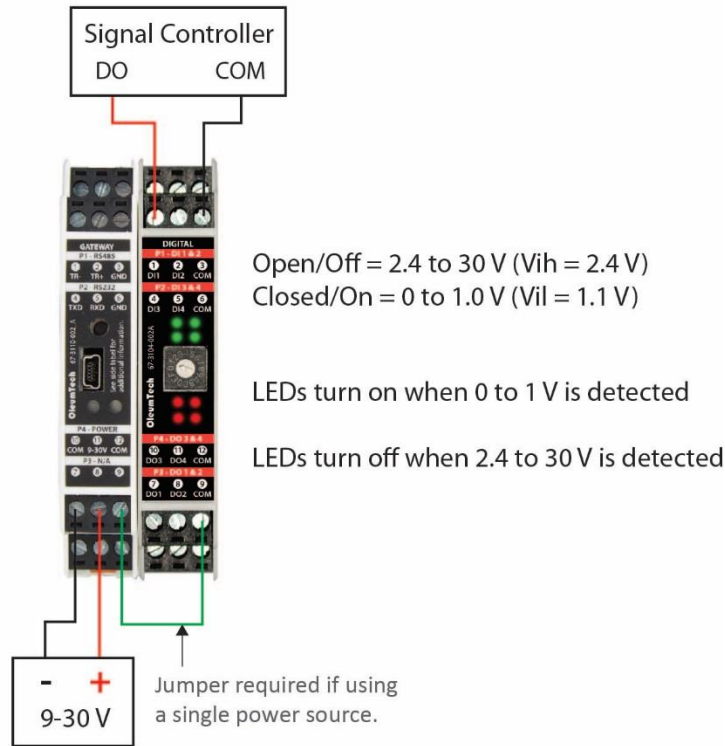

Dry Contact Input



6. Digital Output Wiring

NPN Output

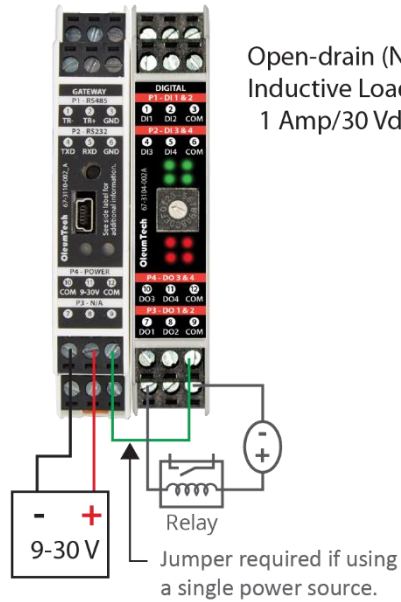

Digital Level Output - Active High

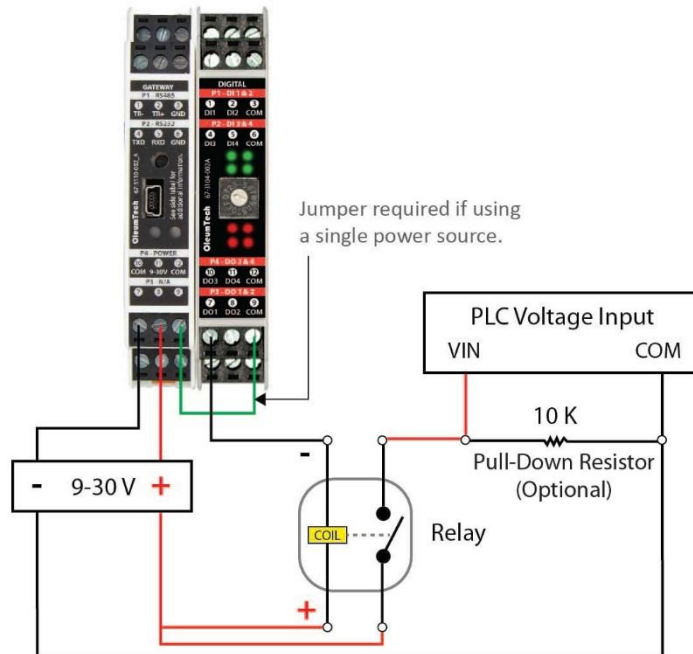

Digital Level Output - Active Low

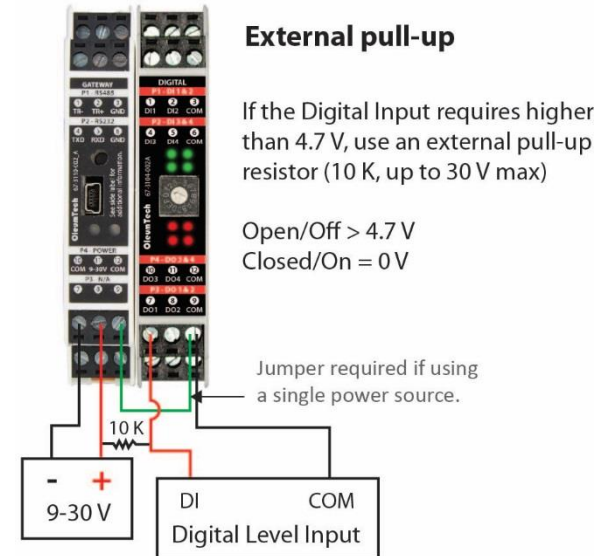

9. GROUNDING RECOMMENDATIONS

1. DO NOT tie earth ground the digital and power ground terminals the wireless gateways.
2. The panel enclosure must be grounded to earth.
3. It is safe to mount OleumTech wireless gateways to the panel enclosure since the chassis and digital/power ground terminals are isolated.
4. Where bulkhead (phantom) antennas are used, the inner surface, outer surface, and inner wall of the hole drilled, should be isolated from the antenna. Use the rubber washers supplied by the manufacturer to isolate the antennas from the enclosures. Use the thickest washer supplied by the manufacturer to isolate the antennas from the enclosures. Use the thickest washer on exterior side of enclosure.

RECOMMANDATIONS DE MISE À LA TERRE

1. Ne pas attacher TERRE les bornes de masse et de puissance numériques sans fil Passerelles.
2. Le boîtier du panneau doit être mis à la terre.
3. Il est sûr de monter OleumTech wireless gateways au boîtier du panneau depuis le châssis et les terminaux / sol de puissance numériques sont isolées.
4. Où cloison (phantom) antennes sont utilisées , la surface intérieure , la surface extérieure , et la paroi intérieure du trou foré , doit être isolé de l'antenne. Utilisez les rondelles en caoutchouc fournies par le fabricant pour isoler les antennes des enceintes (utilisez la plus épaisse rondelle fournie par le fabricant pour isoler les antennes des enceintes (utilisez la plus épaisse rondelle sur côté extérieur de l'enceinte).

Grounding Gateways & I/O Modules:

- Battery negative should never be common with earth ground.
 - For fiberglass enclosures, the backplane inside may be connected to earth ground. Typically, there is a lug specifically for this connection. The equipment inside the enclosure, however, should not be common with the backplane in this case.
 - For steel enclosures, battery negative should not be common with the enclosure as the enclosure will usually be common with the pole supporting it (basically earth ground).
- A. Where bulkhead (black phantom) antennas are used, the inner surface, outer surface, and inner wall of the hole drilled, should be isolated from the antenna. Use the rubber washers supplied by the manufacturer to isolate the antennas from the enclosures (use thickest washer on exterior side of enclosure).
- B. Where external antennas, such as omni-directional and yagi, are utilized, a polyphaser is typically used. The actual connection between lightning arrestor and antenna cable should be isolated. The lightning arrestor itself has its own lug designed to be connected to earth ground.
- Once all wiring and grounding recommendations have been followed it is important to test the ground resistance at the grounding rod to assure a good ground. The most effective grounding method is direct connection to earth ground with minimal impedance. An impedance of less than 5 Ohms is recommended.
 - For more details on proper grounding electrodes and grounding electrode conductors, consult the National Electrical Code.



CAUTION: Ensure field wiring connections are in accordance with Article 504 of the National Electrical Code, ANSI/NFPA70. For more details on proper grounding electrodes and grounding electrode conductors, consult the National Electrical Code.

Terre passerelles et I/O modules:

- Négative batterie ne doit jamais être commun avec la terre.
 - Pour les boîtiers en fibre de verre, le fond de panier à l'intérieur peut être connecté à la terre. En règle générale, il existe une patte spécialement conçue pour cette connexion. Dans ce cas, l'équipement à l'intérieur du boîtier ne doit pas être commun au fond de panier.
 - Pour les boîtiers en acier, le négatif de la batterie ne doit pas être commun avec le boîtier car le boîtier le sera généralement avec le poteau le supportant (essentiellement la terre).
- A. Lorsque des antennes à cloison (fantôme noir) sont utilisées, la surface interne, la surface externe et la paroi interne du trou percé doivent être isolées de l'antenne. Utilisez les rondelles en caoutchouc fournies par le fabricant pour isoler les antennes des boîtiers (utilisez la rondelle la plus épaisse du côté extérieur du boîtier).
- B. Lorsque des antennes externes, telles que les antennes omnidirectionnelles et yagi, sont utilisées, un polyphaseur est généralement utilisé. La connexion réelle entre le parafoudre et le câble d'antenne doit être isolée. Le parafoudre lui-même a sa propre cosse conçue pour être reliée à la terre.
- Une fois que toutes les recommandations de câblage et de mise à la terre ont été suivies, il est important de tester la résistance de la tige de mise à la terre afin de garantir une bonne mise à la terre. La méthode de mise à la terre la plus efficace est la connexion directe à la terre avec une impédance minimale. Une impédance inférieure à 5 Ohms est recommandée.
 - Pour plus de détails sur les électrodes de mise à la terre et les conducteurs d'électrode de mise à la terre, consultez le code national de l'électricité.



ATTENTION: Assurez-vous que les connexions du câblage sur site sont conformes à l'article 504 du Code national de l'électricité, ANSI / NFPA70. Pour plus de détails sur les électrodes de mise à la terre et les conducteurs d'électrode de mise à la terre, consultez le National Electrical Code.

10. INSTALLATION

The following procedure describes how to install the gateway.
Before you perform this procedure, be sure the gateway meets applicable grounding requirements in the enclosure (see previous section).

Special Conditions for Use

- a. All modules are to be used with accessory Data Rail, part number BS-010-BK, rated 150 V max, Ta = -40 °C to 80 °C.
- b. This is OPEN type equipment that must be installed within a suitable end-use enclosure that requires a tool to access, and is appropriately certified (e.g. Ex e, Ex nA, Ex d, Ex p, or equivalent protection), providing a minimum ingress protection level of IP54. The suitability of the enclosure is subject to investigation by local Authority having jurisdiction at the time of installation.
- c. The USB connector shall not be used in normal operation. It is intended for temporary configuration, programming, and diagnostic use during installation and shall not be used unless the area is known to be nonhazardous.
- d. Assessment of the antenna and its wiring is not part of the certificate.
- e. External transient overvoltage protection must be provided in the power supplied to the equipment at a level not exceeding 140% of the rated voltage at the power supply terminals of the apparatus.

INSTALLATION

La procédure suivante explique comment installer la passerelle. Avant de suivre cette procédure, assurez-vous que la passerelle répond aux exigences de mise à la terre applicables dans le boîtier - voir la section précédente).

Conditions particulières d'utilisation

- a. Pour être installé dans une AEX et CSA Ex ou IECEx et ATEX (le cas échéant) enceinte de l'outil sécurisé approuvé avec une cote minimale IP IP54 qui a une plage appropriée de la température de service.
- b. Le montage de l'équipement dans une enceinte appropriée provoquera la température ambiante intérieure de l'enceinte soit supérieure à la température ambiante enceinte externe maximale. L'équipement ne doit pas faire partie de l'enceinte externe (monté sur panneau, par exemple). Les entrées de câbles dans l'enceinte doivent être munis de AEX et CSA Ex ou IECEx et ATEX (le cas échéant) des presse-étoupes certifiés qui ont un minimum de protection d'entrée IP54. Les presse-étoupe ont une plage de température de fonctionnement égale ou supérieure à la température ambiante de fonctionnement.
- c. Protection contre les transitoires doivent être fournis sur la fourniture de limiter les transitoires max. 119 Vpk
- d. L'utilisateur final doit correctement mettre à la terre le boîtier final dans lequel la passerelle sera installée. L'utilisateur final doit vérifier la «continuité de la terre» après la mise à la terre.
- e. L'équipement ne doit être utilisé dans une zone ne dépassant pas le degré de pollution 2, tel que défini dans la norme IEC 60664-1.

Remarque: Ex Approbation de l'enceinte et des presse-étoupes subordonnée à la conformité aux règlements locaux en vigueur.

1. DH2-W and I/O Module(s) Assembly

WARNING: The power must be disconnected or turn off prior to attaching or removing any I/O modules from the system – failure to comply may cause damage to the hardware.

Standalone Mode (No I/O modules)

1. Attach the DH2-W directly onto a 35mm DIN rail.



I/O Expansion Mode

1. Securely attach the DataRail onto a 35 mm x 7.5 mm DIN rail by gently pressing on all four (4) corner clips.

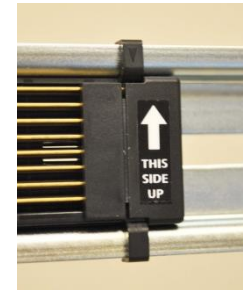

WARNING: Must attach the DataRail with the arrow label pointing up.

2. Secure the DataRail by attaching an End Terminal Bracket.
 - a. Hook the metal end of the bracket to the DIN rail, then snap the other end onto the DIN rail. Be sure to position the bracket far left of the DataRail where metal blades meet the plastic)

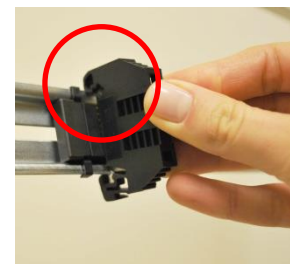
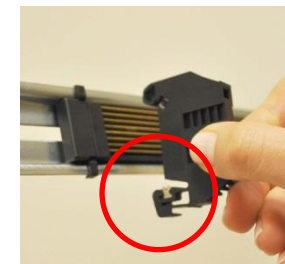
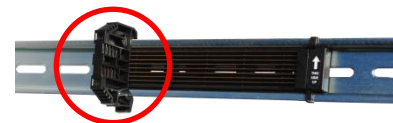

3. Attach the gateway to the DataRail (place it next to the Bracket without any gap).
 - a. Latch the top hook onto the rail, then snap-in the spring-loaded clip into place.



4. Attach the I/O module(s) to the system (left to right without any gaps).
 - a. Place the I/O modules in any combination.
 - b. When using more than five (5) I/O modules, determine maximum I/O module combination by using power budget calculator. [CLICK HERE http://goo.gl/t67r3k](http://goo.gl/t67r3k)

WARNING: The power must be disconnected or turn off prior to attaching or removing any I/O Modules from the system – failure to comply may cause damage to the I/O Module(s)



5. Set the device slave IDs on the I/O modules.
 - a. Use the 16-position switch located on the front of each I/O module to set the device ID(s).
 - b. Each module must have its own ID.



SLAVE ID =

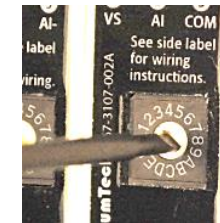

Configuration switches and rotary module identification switches must not be operated unless the area is known to be nonhazardous.

6. Attach the other End Terminal Bracket to secure the modules (place it next to the last module without a gap).



7. Protect any unused DataRail slots with the cover. Snap-off extra pieces and store them for future use.



8. Terminate I/O and supply power as required. Use solid or stranded wire (AWG) 28-12.

9. How to detach the components from the DIN rail.
 - a. The End Terminal Bracket can be removed from the DIN rail by inserting the tip of a flathead screwdriver into the removal slot. Control the direction with the screwdriver handle to pull the latch away from the din rail for safe removal.

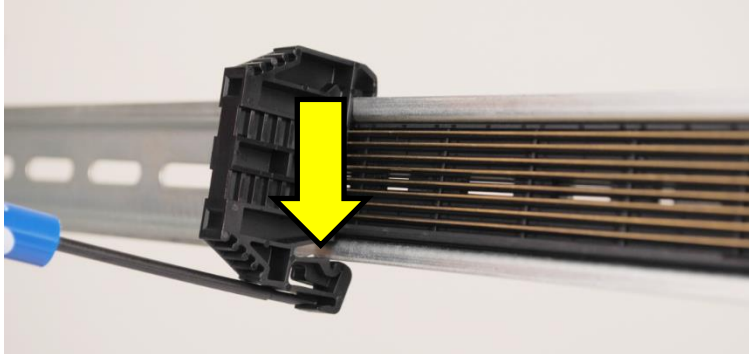

- b. The gateway and I/O modules can be removed from the din rail by inserting the tip of a flathead screwdriver into removal slot located on the metal clip. Lift-up on the screwdriver handle to pull the spring-loaded clip away from the din rail for safe removal.

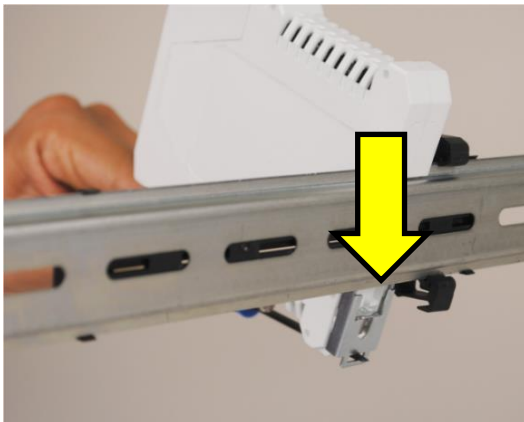

2. Connect the antenna

- a. Firmly hold and connect the MMCX end of the antenna cable to the gateway's radio connection terminal (listen for a "click" sound for confirmation).
- b. Connect the Lightning Arrestor (optional – highly recommended).
- c. Drilling a hole may be required for routing the antenna cable. Use a 5/8" or larger diameter hole. User must supply their own O-ring/seal.
- d. Use proper fittings to seal the hole for antenna cable.
- e. Where bulkhead (black phantom) antennas are used, the inner surface, outer surface, and inner wall of the hole drilled, should be isolated from the antenna. Use the rubber washers supplied by manufacturer to isolate the antenna from the enclosures (use thickest washer supplied by manufacturer to isolate the antenna from the enclosure (use thickest washer on the exterior side of the enclosure)).
- f. Install the antenna and connect all cables.
- g. Must install the omni or bulkhead antenna in the upright position. Do not mount it sideways!



- h. Do not install other antennas on the same vertical plane – provide sufficient vertical separation.

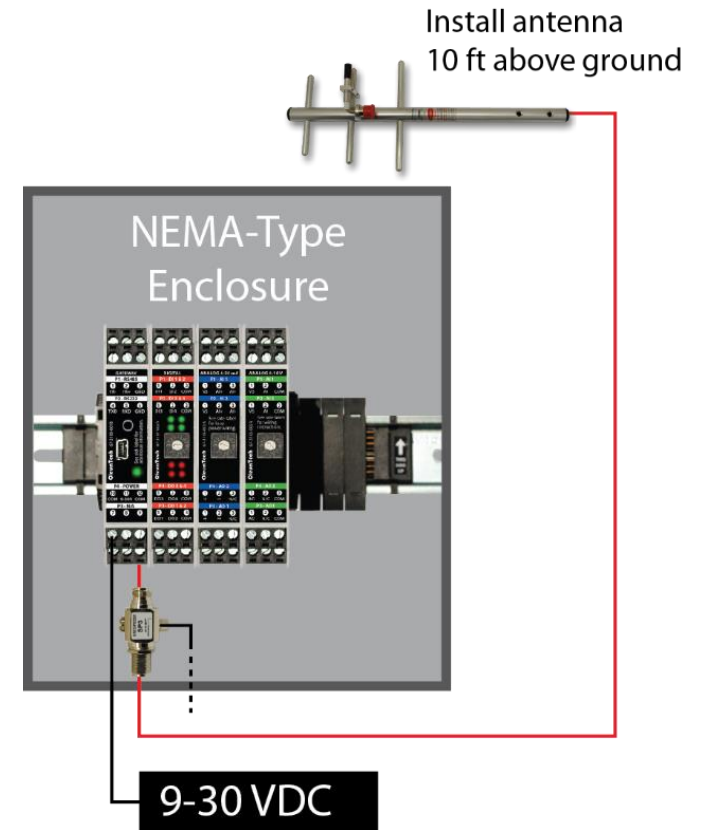

11. RF SETUP / RF SECURITY

1. Clear Line of Sight

A clear line of sight with minimal obstructions is necessary for best wireless (RF) communication. Performing a RF survey is highly recommended prior to commissioning.

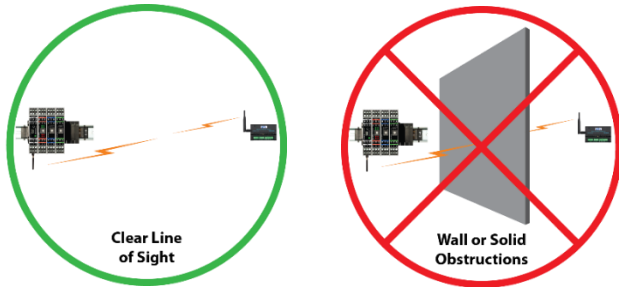

2. Maximum RF Range*

900 MHz: Up to 7500 Feet / 1.4 Miles / 2.3 km (Transmitter to Gateway)

900 MHz: Up to 40 Miles / 64 km (Gateway to Gateway)

[Refer to 900 MHz RF Range Guide](#)

2.4 GHz: Up to 4.3 Miles / 7 km with Clear Line of Sight*

[Refer to 2.4 GHz RF Range Guide](#)

868 MHz: Up to 5.2 Miles / 8.4 km

*The maximum RF range data was collected under optimal test conditions, including a clear line of sight between antennas. Actual wireless RF range may vary depending on location, RF interference, weather, antenna type, cable type, and line of sight.

3. Received Signal Strength Indication (RSSI)

RSSI value can be exported as a Modbus register to monitor the RF health from end Transmitter(s) to Gateway.

RSSI Reading:

Excellent = 40-75; Good = 76-90; Weak = 91-115

4. RF Timeout Tag

When setting up Transmitters, RF Timeout tag can also be added as a Modbus register for monitoring RF health. Timeout trigger is normally set to three times the Tx interval. This means when the data packet is missed on three consecutive interval attempts, the RF timeout will be flagged.

0=RF OK; 1= RF Timeout

5. RF Refresh Tag for ensuring RF and device health

When setting up Transmitters, RF Refresh tag can also be added as a Modbus register for trending RF data using a third-party device.

6. Maximum Number of End Transmitter Support per Gateway

Each Gateway can support a maximum of 63 Transmitters. This can be a combination of Wireless Transmitters and Wireless I/O Modules.

Major factors that contribute to actual support of maximum End Transmitters depends on transmission frequency, RF frequency, RF propagation, RF data (bit) rate, and physical/geographical limitation or challenges as well as RF interferences.

If a Gateway is also connected wirelessly to other Gateways for peer-to-peer data sharing and control applications, achieving 63 maximum end Transmitter support may not be feasible due to limitation of RF budget, speed, and processing payload.

When a project requires usage of more than 10 end Transmitters per Gateway or is more complex than a basic Wireless Sensor Network that involves a Gateway and a handful of End Transmitters, please consult with an OleumTech Application Engineer or a Certified Specialist to properly commission a project.

7. RF Enhancements

To ensure data reliability and delivery over RF, OleumTech Wireless Sensor and I/O Network provides RF collision detection for 900 MHz radio version and RF collision avoidance with 2.4 GHz radio version products.

8. RF Security

AES Encryption

OTC Wireless Sensor and I/O Network provides the ability to enable over-the-air encryption using AES. The 900 MHz radio version supports 256-bit AES encryption whereas the 868 MHz, 915 MHz, and 2.4 GHz versions support 128-bit AES encryption.

Minimum software/firmware revision levels for AES Encryption feature:

- BreeZ Software v5.1 or later
- DH3 v1.0 or later
- DH1 (Base Unit) / DH2 / DH2-W v2.0 (RF2) or later
- WT Series Transmitters v2.0 (RF2) or later
- SM/LM Series Transmitters v3.0 (RF2) or later
- SM Series Resistive Transmitter v1.1.0.0 or later
- Wireless I/O Modules v2.0 or later

Site Authentication

OleumTech Wireless Sensor and I/O Network also provides users the ability to enable Site Authentication. This method further extends security measures and eliminates or minimizes crosstalk with neighboring networks.

How to Enable RF Security in BreeZ v5.1 or later.

- a. Open or create a BreeZ project file (v5.1 or later).
- b. Right-click on **Site** in the project tree and select **Edit**.

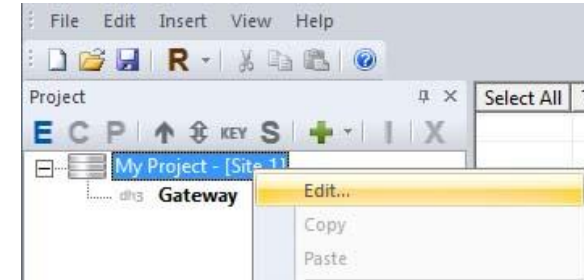

- c. Check **Enhanced Site Security** to enable Site Authentication.
- d. Check **Enable AES Encryption** to enable AES encryption.

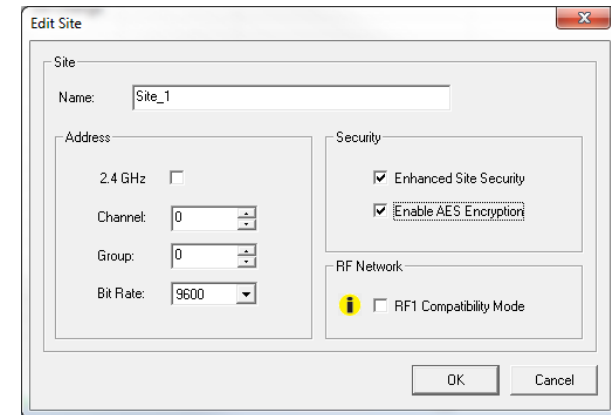

- e. Save the project file.
- f. Upgrade all wireless device firmware to version that supports AES.
- g. Update all wireless devices in the project file.

9. 900 MHz Bit Rate

In the above window, there are two bit rate options for 900 MHz. If a network contains heavy RF traffic and/or fast Tx interval, using the higher 115,200-bit rate will solve majority of RF issues. When using the higher bit rate, be sure to check RSSI to ensure RF signal integrity due to shortened RF range.

12. DOWNLOAD & INSTALL THE SOFTWARE

1. Go to the OleumTech Download Center and register to gain access. <https://support.oleumtech.com/>
2. Find the latest version of the BreeZ Software and download it.
3. Install the BreeZ Software on your PC.

13. CREATE A PROJECT FILE USING THE SOFTWARE

1. Run the BreeZ Software on your PC.



2. Click **New Project** in the project creation wizard.



3. Edit the project settings.

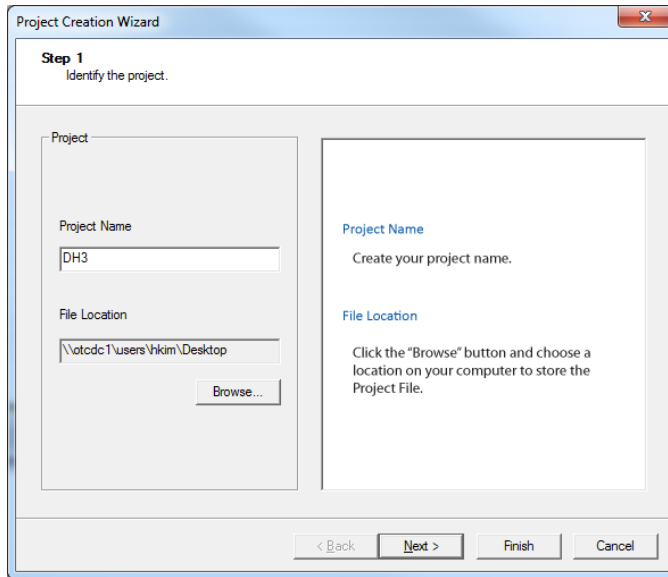

- a. Create a **Project Name**.
- b. Select a **File Location** by clicking on the **Browse** button.
- c. Click **Next**.

4. Configure the RF settings.

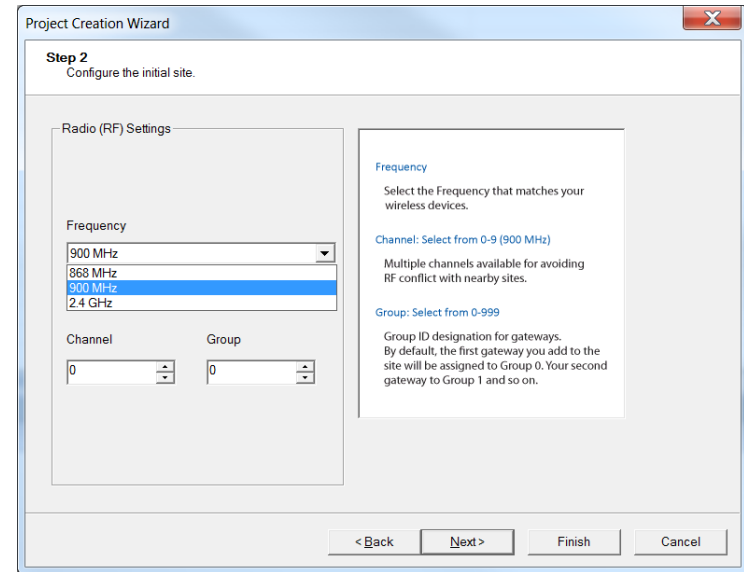

- a. Select the **Frequency** that matches the radio frequency of the wireless devices.
- b. Select a **Channel** to avoid any RF conflict with any nearby sites.
- c. Select a **Group** - by default, the first gateway you add to the site will be assigned to 0. The second gateway added will be assigned 1 and so on.



Do not use Channel 0, Group 0. It is too common.
N'utilisez pas Channel 0, Group 0. C'est trop commun.

- d. Click **Next**.

5. Configure the primary wireless gateway.

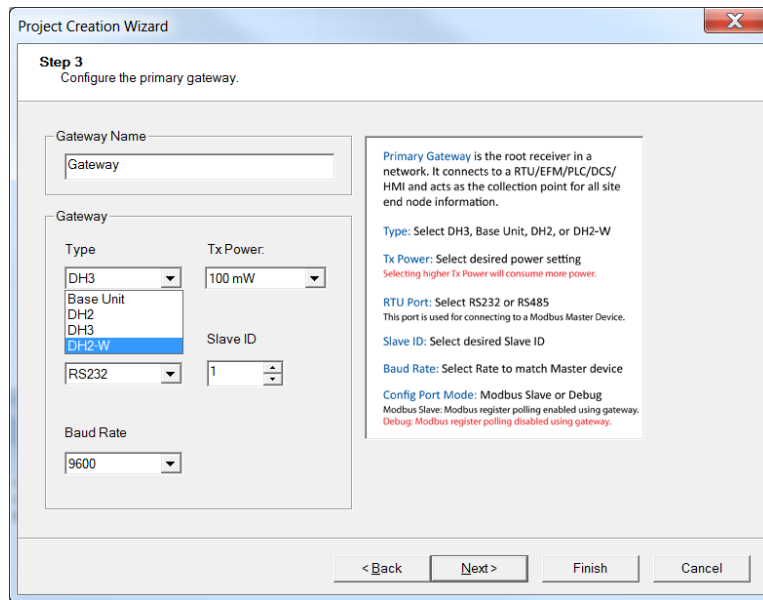

- a. Create a **Gateway Name**.
- b. Select the **Type** (DH2-W).
- c. Select **Tx Power** – Selecting a higher transmit setting consumes more power.
- d. Select **RTU Port 1** RS232 or RS485 (terminal block).
- e. Select **Slave ID**.
- f. Select **Baud Rate** that matches the Master device.
- g. Click **Next**.

6. Add the transmitter(s) (WT Series RTD used as an example).
See specific product User Guide for detailed instructions.

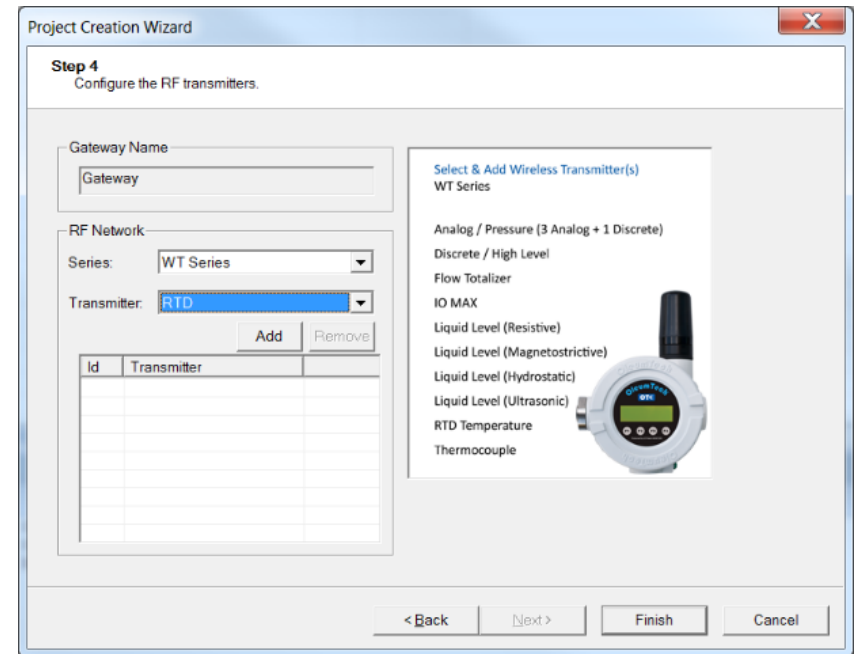

- a. **Series** – Select WT Series – LCD.
- b. **Transmitter**: Select RTD.
- c. Click **Add**.

7. Configure the transmitter.

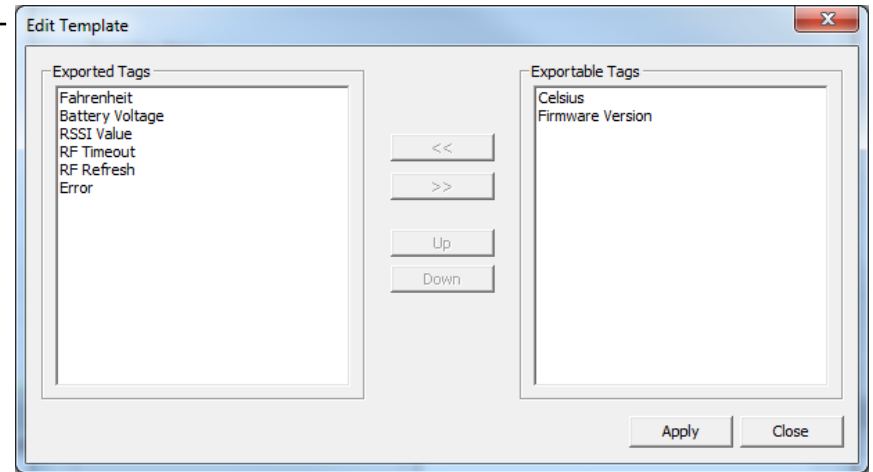
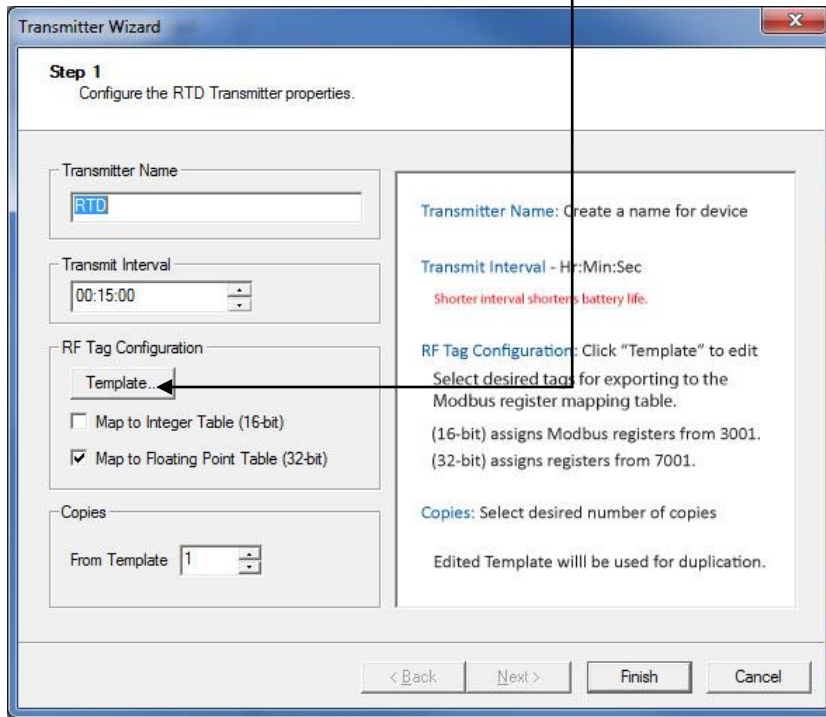

- a. Create a **Transmitter Name**.
- b. Enter a **Transmit Interval** in Hr:Min:Sec.
- c. Select **Map to Integer Table** or **Map to Floating Point Table**.
 - i. Default **Integer Table** begins at register **3001**.
 - ii. Default **Floating Point Table** begins at register **7001**.
- d. **Copies**: Enter the number of transmitters that you want to populate to the project using these settings.
- e. Click **Template** to open **Edit Template** window.

- f. Modify the **Edit Template** to desired settings. The tags listed under the **Exported Tags** will automatically be added to the Modbus Mapping Table.
 - i. **Fahrenheit**: Temperature unit
 - ii. **Celsius**: Temperature unit
 - iii. **Battery Voltage**: Indicates the battery level: ≥ 2.9 V is good.
 - iv. **RF Timeout**: 0 = RF OK ; 1 = RF transmission failure
 - v. **RSSI Value**: Received Signal Strength Indication (Transmitter to Gateway)
 - 1. Excellent signal = 40-75; Good signal = 76-90; Weak signal = 91-115
 - 2. No signal = 0 (When RF times out, RSSI reports 0)
 - vi. **RF Refresh**: Helpful when trending RF data using a third-party device.

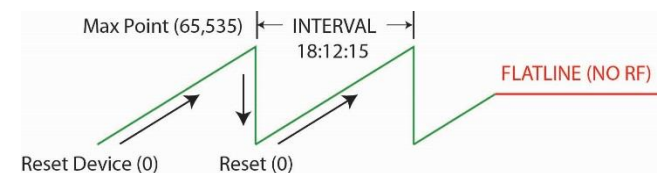

- vii. **Firmware Version**
- viii. **Error**
- g. Click **Apply** save template changes (optional).
- h. Click **Close** to exit the **Edit Template** window.
- i. Click **Next**.

8. Configure the additional transmitter parameters.

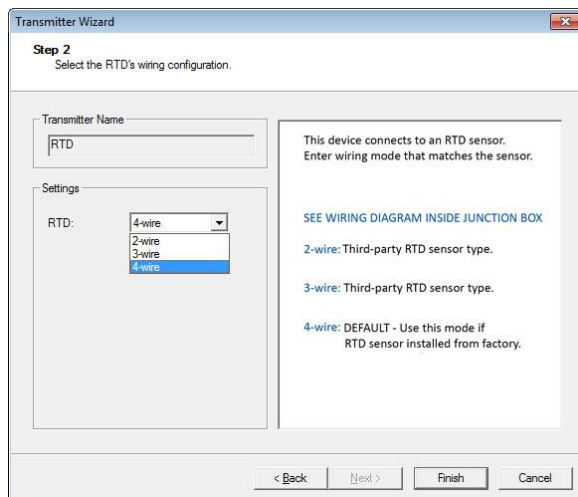

- a. Select RTD wiring mode that matches the sensor (2, 3 or 4).
- b. 4-wire type is factory default for the direct mount version WT-RT1.
- c. Click **Finish**.

9. Confirm addition of the transmitter.

- a. Verify the added transmitter(s) in the device table.
- b. Add more transmitters if desired.
- c. Click **Finish**.

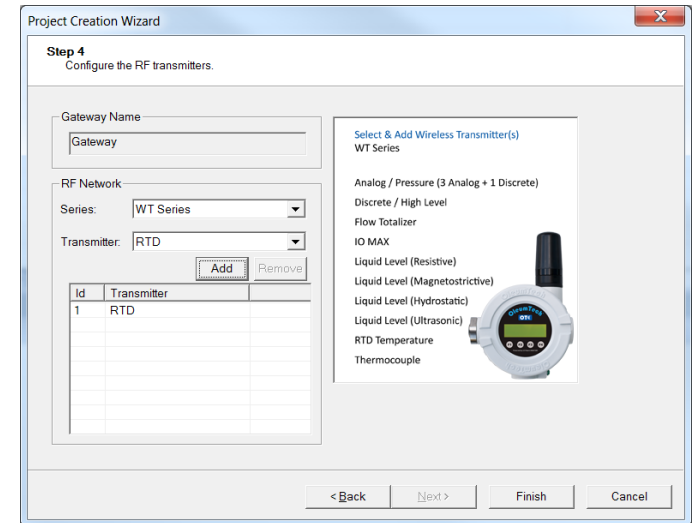

- d. Click **Confirm**.

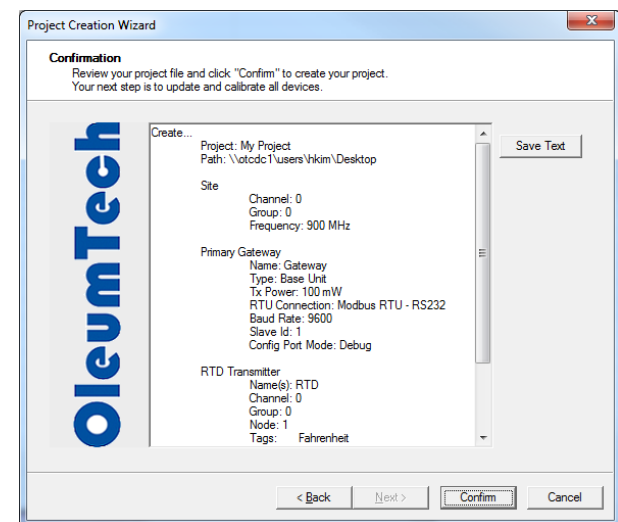

14. SOFTWARE MAIN SCREEN VIEW

Open
Open an existing file

Save
Save current file

Update
Allows updating or programming a connected device (it must be connected to PC)

Connect
Allows access to a connected device (it must be connected to PC)

COM Port
Allows users to quickly select a COM port

New
Create a new project file

Retrieve
Access project file stored on a gateway

Edit
Allows access to selected item's properties and settings within the project file

Copy & Paste
Allows user to copy and paste devices in the project tree

Project Tree
Contains hierarchy of devices contained in the project file

Add a device

Delete a device

Device Tabs
Double-click on a device in project tree, then click on desired tab to access information

Build Tab
Provides diagnostic acknowledgements from device when a command is given

```
Output
Build Debug DHS Debug
14:45:23.808- Gateway - File successfully downloaded.
```

Debug Tab
Shows BreeZ-related success or error response in communication when manually interfacing with the gateway e.g. Poll Modbus Registers

```
Output
Build Debug DHS Debug
11:54:45.074- -> 00 00 00 00 00 06 01 03 1B 59 00 07
11:54:45.274- Modbus Response: success.
11:54:45.276- <- 00 00 00 00 00 1F 01 03 1C 42 8C 9A 5E 41 AA
11:54:45.279- 3A 93 40 50 33 F0 42 20 00 00 00 00 00 00 46
11:54:45.282- 98 86 00 00 00 00 00
12:01:38.649- Modbus Request: id 1, registers 7001 to 7007...
12:01:38.652- -> 01 00 00 00 00 06 01 03 1B 59 00 07
12:01:38.948- Modbus Response: success.
12:01:38.951- <- 01 00 00 00 00 1F 01 03 1C 42 8B F7 DC 41 A8
12:01:38.953- D1 83 40 50 C0 05 42 20 00 00 00 00 00 00 46
12:01:38.955- 9B AE 00 00 00 00 00
```

DH3 Debug Tab
The DH3 Debug Tab shows debug info reported from the DH3 itself.

```
Output
Build Debug DHS Debug
15:00:00.830- Connected to BreeZ.
15:00:02.122- Radio: received packet from host 1. RSSI: 40.
15:00:42.915- BreeZ update complete.
15:00:44.850- RTU1: Modbus Slave (RS232) initialized.
15:00:45.050- RTU2: Modbus Slave (RS232) initialized.
15:00:45.444- Ethernet Port: Modbus Master (TCP) initialized.
15:00:47.626- Radio detected: 900 MHz.
15:01:01.133- Radio: received packet from host 1. RSSI: 40.
```

How to manage devices in the BreeZ Software.

1. **Editing device properties:**

- a. Click on the desired device in the project tree.
- b. Click the **E** icon (Edit) button.

2. **Adding another transmitter or I/O module:**

- a. Click on the gateway in the project tree.
- b. Click the **+** icon (insert) button.
- c. Select a desired device.

3. **Adding another gateway:**

- a. Click on the site in the project tree.
- b. Click the **+** icon (Insert) button.
- c. Select a desired gateway.

4. **Renaming a device:**

- a. Right-click over a device in the project tree.
- b. Select rename.

5. **Removing a device from the project tree:**

- a. Click on the desired device.
- b. Click the **X** icon (Delete) button.



When a transmitter is removed from the project tree, it also removes the RF host address, which leaves a gap in the addressing sequence. To remove any gap in the RF Host Address table or modify a transmitter's RF host address, see the instructions provided in the Managing RF Host Addressing Table section.

6. **Disabling a device from the project tree:**

- a. Right-click on the desired device.
- b. Select **Disable Device** function.
- c. Once a device is disabled, it will be completely disregarded from the project and the device name will be displayed in grey text.

7. **Duplicating a set of gateway and transmitter(s):**

This function allows you to quickly replicate devices in the project (supported in BreeZ v6 or later).

- a. Right-click on the desired gateway and select **Copy**.

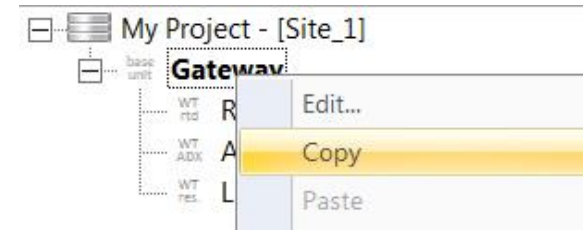

- b. Then, right-click on **Site** in the project tree and select **Paste**.

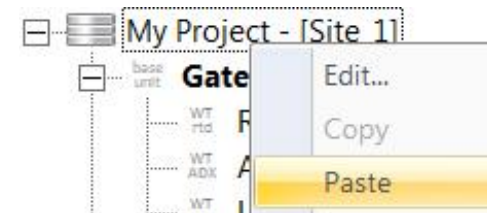

- c. The gateway and its set of transmitters will be duplicated in the project tree.

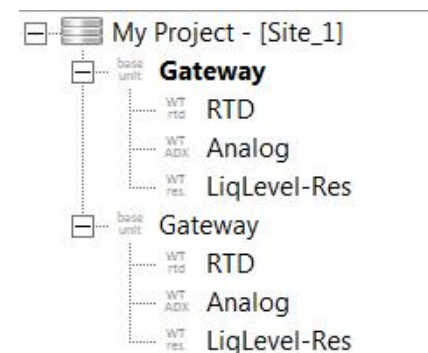

d. Create Modbus registers.

The duplicated gateway's Modbus mapping table must be manually configured.

- i. Double-click on the duplicated gateway and select the **Imports** tab.
- ii. Select the desired points.
- iii. Right-click over the selected points and select **Paste to Integer or Float Table**.

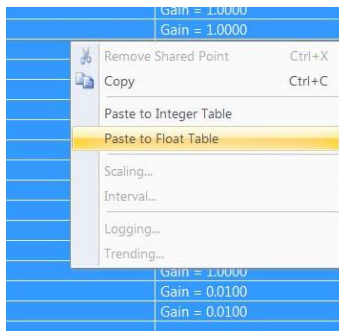

iv. Edit the Modbus table if necessary.

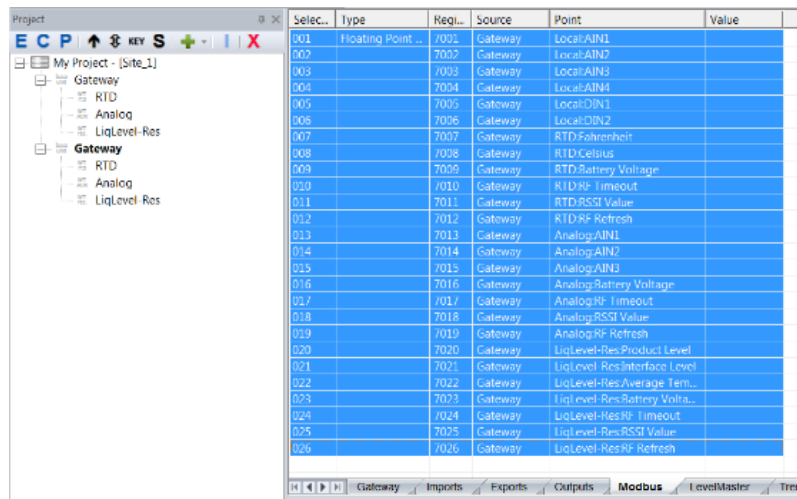

15. EDITING THE GATEWAY PROPERTIES

1. How to access the gateway's properties window.

- a. Click on the gateway in the project tree, right-click over it and select **Edit** or click on the **E** button

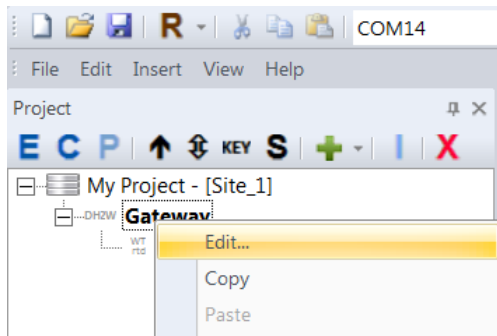

2. Radio Tab

- a. Allows adjusting of the transmit (Tx) power level and number of retries.
Increasing the Tx power increases the RF range while consuming more power.

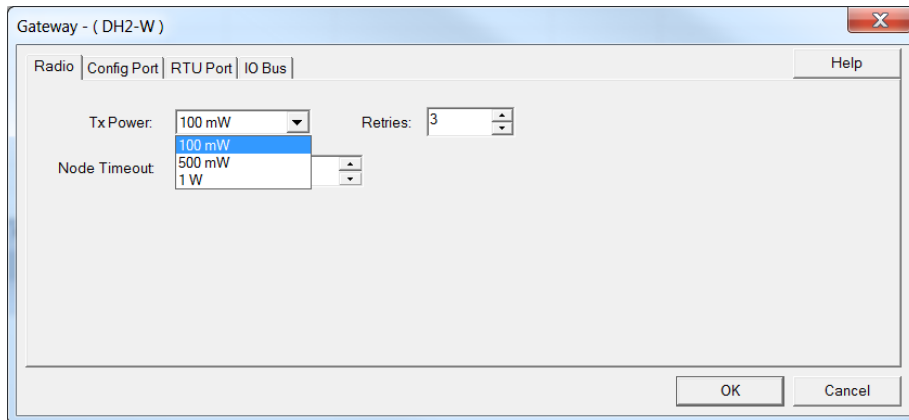

3. Serial/RTU Port Tab

- a. Allows the modification Serial/RTU Port configuration.
- b. The port can be configured as a Modbus Master, Modbus Slave, LevelMaster ASCII Slave, or ROC-Link Master.
- c. The port can be configured for RS232 or RS485 operation.
- d. Match the RTU Port settings with the port settings of the connected third-party device.

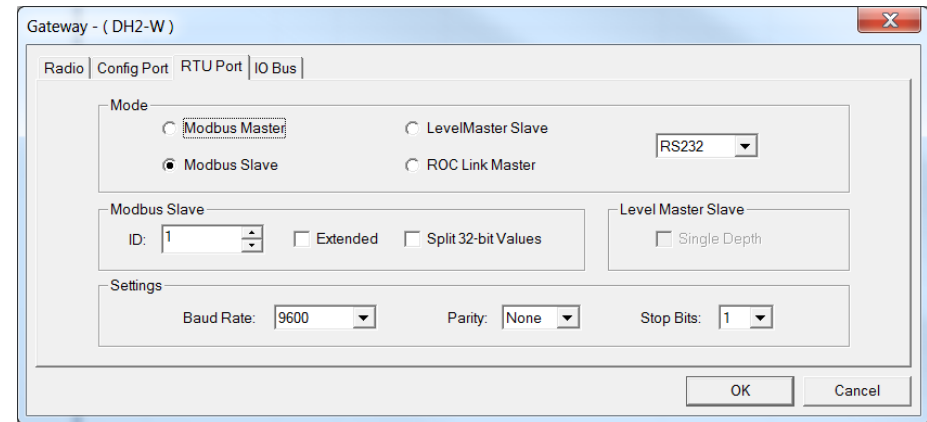

- e. The gateway can be configured to support the following ROC-Link Master Opcodes:
 - i. Opcode 17, Login Request.
 - ii. Opcode 10, Read Configurable Opcode Point Data.
 - iii. Allows user to read up to 10 user configurable (TLP) points from a ROC.
 - iv. Points can be a mix of type UINT16 (unsigned) or FL(OAT).

4. Config Port Tab

- a. Allows the modification the Configuration (COM) port.
- b. **Mode:** select **Modbus Slave** or **Debug**.
- c. **Slave Properties:** leave as is.
- d. **Settings:** leave as is.

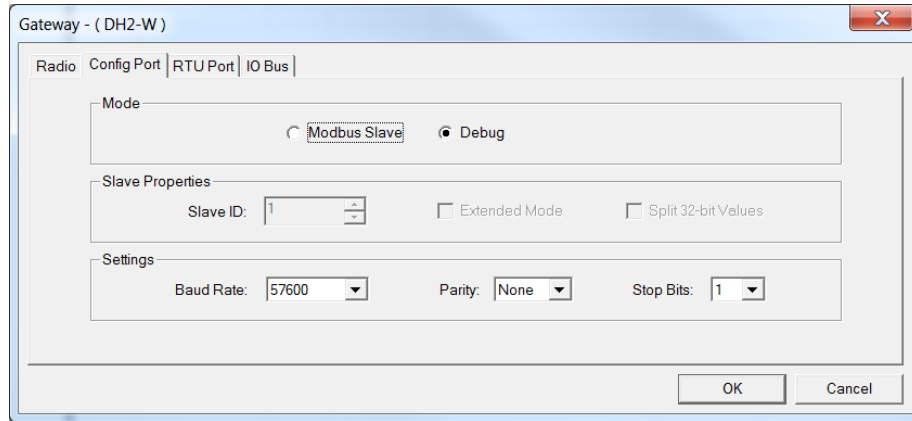

5. IO Bus

- a. Allows insertion of the I/O Modules: Digital, 4-20 mA, 0-10 V (isolated).

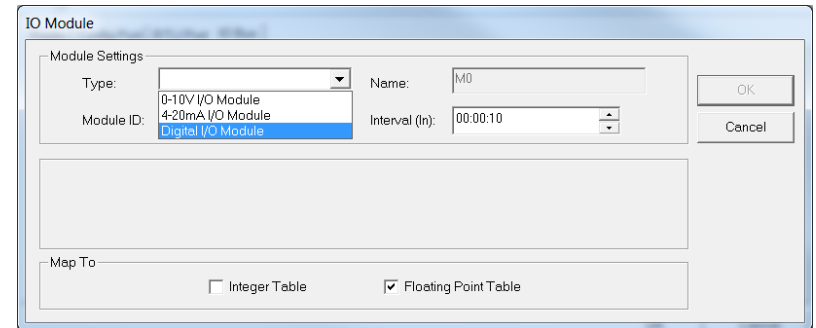
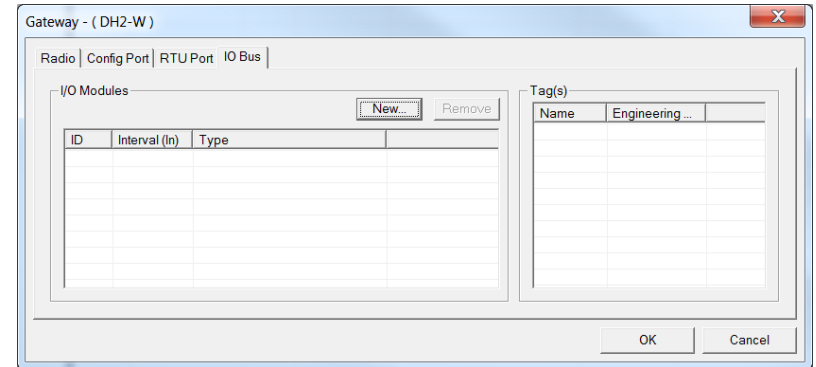

16. MODBUS MAPPING TABLE MANAGEMENT

The DH2-W can hold up to 1920 registers. Please use the following instructions to manage the gateway's Modbus table.

1. Double-click on the desired gateway in the project tree.

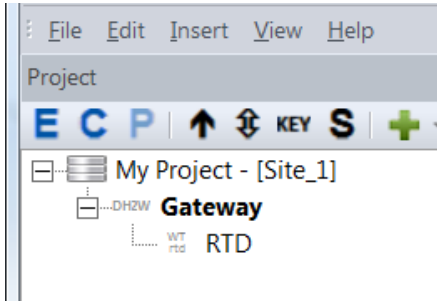

2. Click on the Modbus tab.

Select All	Type	Register	Source	Point
001	Floating Point (32-...	7001	Gateway	RTD:Fahrenheit
002		7002	Gateway	RTD:Battery Voltage
003		7003	Gateway	RTD:RSSI Value
004		7004	Gateway	RTD:RF Timeout
005		7005	Gateway	RTD:RF Refresh
006		7006	Gateway	RTD:Error

3. Edit the registers if necessary.

- Remove: Right-click over desired register and select **Delete**.
- Rearrange: Use the click and drag function of the mouse.
- To add a register(s), see subsection 5.

4. How to export the Modbus mapping table in BreeZ.

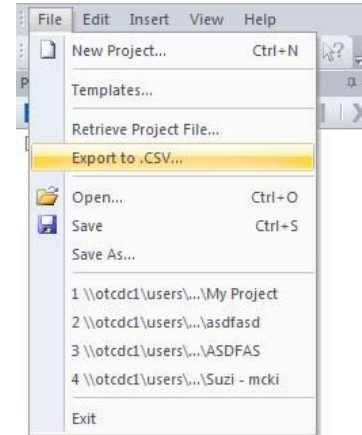

- Click on **File** menu.
- Select **Export to .CSV...**
- The exported file will be saved automatically to the same directory as the project file.
- You can also check the **Output Build tab** window for visual confirmation.

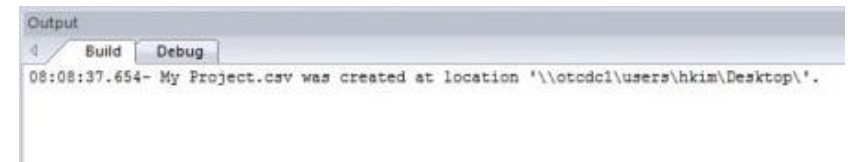

5. How to add a register from a device.

- a. Single-click on the desired transmitter in the project tree.



- b. Click the **E Edit** button.

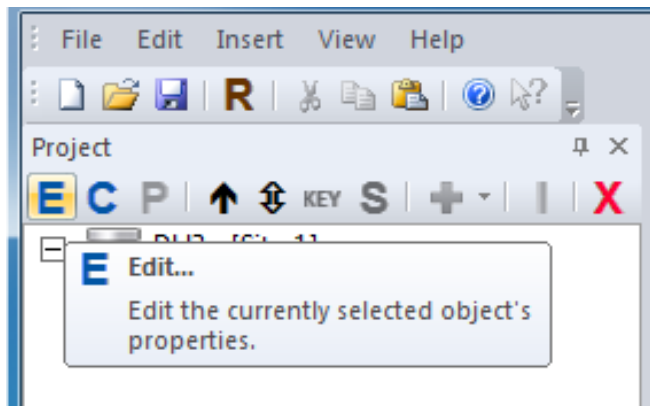

- c. Select a tag(s) from **Exportable Tags** box.

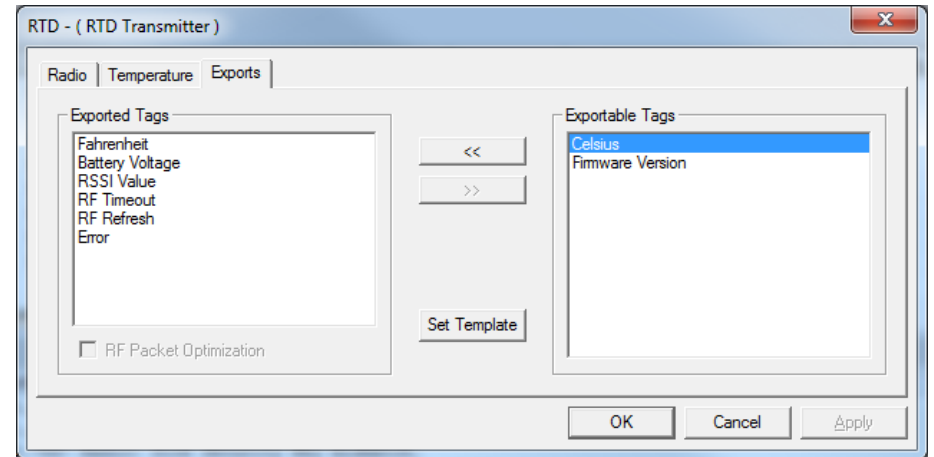

- d. Use the left arrow to move it over to **Exported Tags** box.

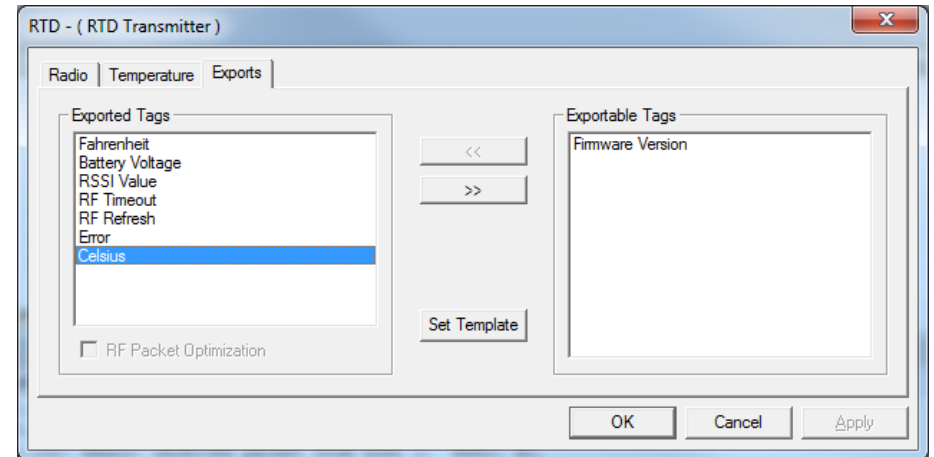

- e. Click **OK** when finished.

f. Double-click on the gateway in the project tree.

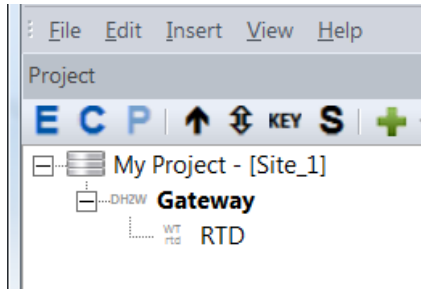

g. Click on the **Imports** tab.

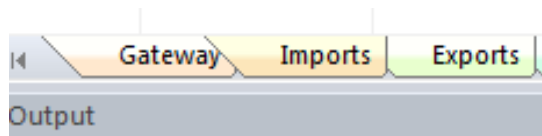

- h. Select the newly added or desired tag(s).
- i. Right-click over selected area and choose **Paste to Integer** or **Paste to Floats Table**.

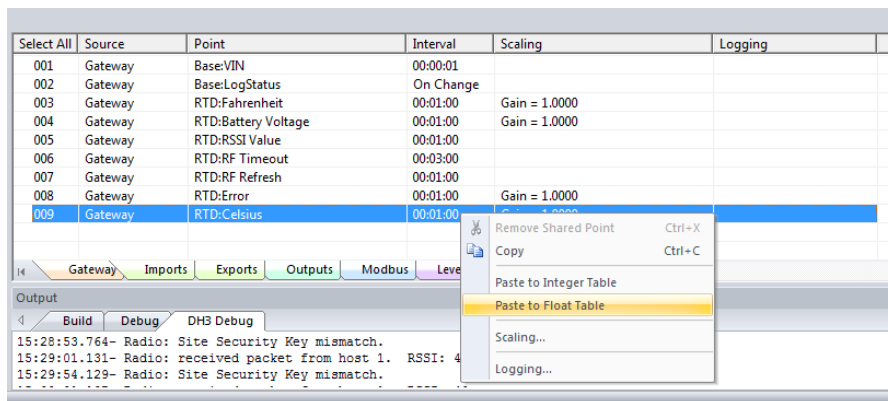

j. Click the **Modbus** tab to verify the added register(s).

Select All	Type	Register	Source	Point	Value
001	Floating Point (32-...	7001	Gateway	RTD:Fahrenheit	67.6341
002		7002	Gateway	RTD:Battery Voltage	3.2654
003		7003	Gateway	RTD:RSSI Value	40.0000
004		7004	Gateway	RTD:RF Timeout	0.0000
005		7005	Gateway	RTD:RF Refresh	33655.0000
006		7006	Gateway	RTD:Error	0.0000
007		7007	Gateway	RTD:Celsius	

k. You can use the click and drag mouse functions to place the registers in the desired location.

Select All	Type	Register	Source	Point	Value
001	Floating Point (32-...	7001	Gateway	RTD:Fahrenheit	67.6341
002		7002	Gateway	RTD:Celsius	
003		7003	Gateway	RTD:Battery Voltage	3.2654
004		7004	Gateway	RTD:RSSI Value	40.0000
005		7005	Gateway	RTD:RF Timeout	0.0000
006		7006	Gateway	RTD:RF Refresh	33655.0000
007		7007	Gateway	RTD:Error	0.0000



Anytime when a project file is modified, the file must be saved and the impacted device(s) must be updated for the changes to take effect.

6. Flexible Modbus Register Table Management System

BreeZ v6.1 or higher enables you to edit or change any Modbus register or group of registers within the Modbus table. Having gaps between register blocks are now allowed in BreeZ for the sake of adding flexibility to interface third-party Modbus Master devices.



Significant change as to how a gateway treats Modbus register gaps when responding to a polling request depends on the firmware version.

DH3: v1.6.0.5-RF2 or later

DH1 / DH2 / DH-2-W: v2.3.0.4-RF2 or later

Any empty register or gap in the Modbus table will report a “0” to allow contiguous reporting to fulfill the entire polling block request.

Previous firmware: if Modbus polling request contains an empty register or a gap, then only the valid register data up to where the first gap is found will be reported along with an **Register(s) not found error** message to notify there is a mismatch between polling request and available register data.

- f. To use this feature, click on the **Modbus** tab and select the desired Modbus register(s), then right-click over the highlighted area, and select **Create New Modbus Group**.

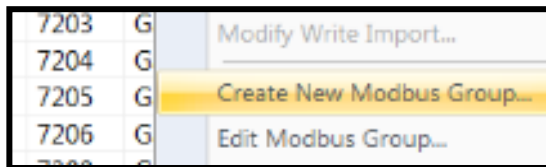
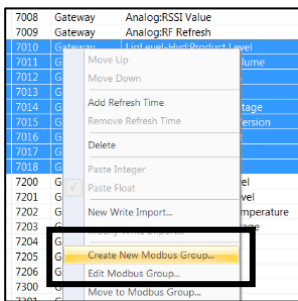

- g. Then, enter desired starting register (7100) and click **OK**.

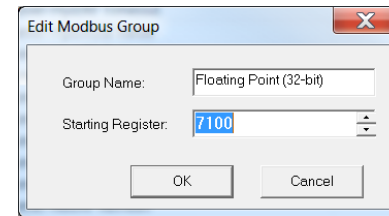

The highlighted register block now shows with a new register starting point (**7100**).

It also shows a break or gap in the table (gapped between 7009 and 7100 and also between 7108 and 7200).

Selec...	Type	Regi...	Source	Point
001	Floating Point (32-bit)	7001	Gateway	Analog:AIN1
002		7002	Gateway	Analog:AIN2
003		7003	Gateway	Analog:AIN3
004		7004	Gateway	Analog:DIN1
005		7005	Gateway	Analog:DIN1 Count
006		7006	Gateway	Analog:Battery Voltage
007		7007	Gateway	Analog:RF Timeout
008		7008	Gateway	Analog:RSSI Value
009		7009	Gateway	Analog:RF Refresh
010	Floating Point (32-bit)	7100	Gateway	LiqLevel-Hyd:Product Level
011		7101	Gateway	LiqLevel-Hyd:Product Volume
012		7102	Gateway	LiqLevel-Hyd:Tank Full %
013		7103	Gateway	LiqLevel-Hyd:Error
014		7104	Gateway	LiqLevel-Hyd:Battery Voltage
015		7105	Gateway	LiqLevel-Hyd:Firmware Version
016		7106	Gateway	LiqLevel-Hyd:RF Timeout
017		7107	Gateway	LiqLevel-Hyd:RSSI Value
018		7108	Gateway	LiqLevel-Hyd:RF Refresh
019	Floating Point (32-bit)	7200	Gateway	LiqLevel-Res:Product Level
020		7201	Gateway	LiqLevel-Res:Interface Level
021		7202	Gateway	LiqLevel-Res:Averade Temperature

		7007	Gateway	Analog:RF Timeout
		7008	Gateway	Analog:RSSI Value
		7009	Gateway	Analog:RF Refresh
nt (32-bit)		7100	Gateway	LiqLevel-Hyd:Product Level
		7101	Gateway	LiqLevel-Hyd:Product Volume
		7102	Gateway	LiqLevel-Hyd:Tank Full %
		7103	Gateway	LiqLevel-Hyd:Error
		7104	Gateway	LiqLevel-Hyd:Battery Voltage
		7105	Gateway	LiqLevel-Hyd:Firmware Versio
		7106	Gateway	LiqLevel-Hyd:RF Timeout
		7107	Gateway	LiqLevel-Hyd:RSSI Value
		7108	Gateway	LiqLevel-Hyd:RF Refresh
nt (32-bit)		7200	Gateway	LiqLevel-Res:Product Level
		7201	Gateway	LiqLevel-Res:Interface Level

h. How to revert back to the default register settings.

To revert back to the default registers: select all registers by using **Ctrl+A** keys on your keyboard or click on **Select All** column header. Then, right-click over highlighted area and select **Create New Modbus Group**. Then, enter starting register 7001 for 32-bit or 3001 for 16-bit data.

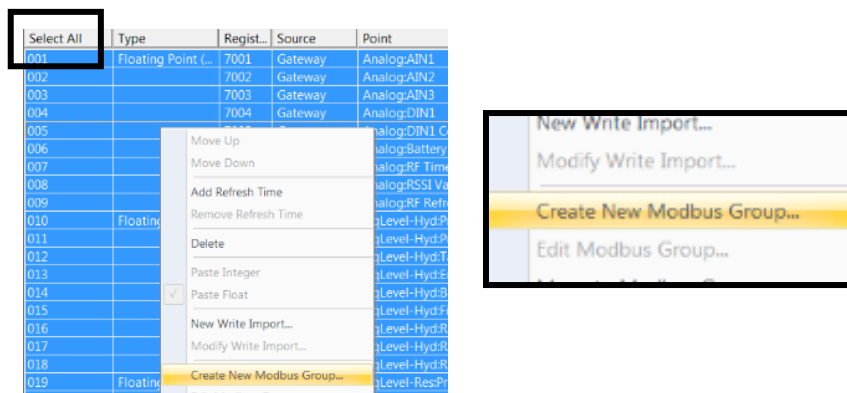

 This feature has **No Undo** function so please take caution before committing to any changes.

This feature **can introduce duplicate registers** so properly organizing registers is critical.

When there is a situation where there are duplicate registers, the last known value will be held in the register.

17. RF HOST ADDRESS MANAGEMENT

These features are only available on BreeZ v6.0 or later.

1. Ability to compact the RF Host address space.

This feature allows the RF Host address space to be compacted to remove any gaps in the transmitter ordering sequence in the project tree.

 When a transmitter is removed from BreeZ, its associated RF Host address is not automatically reclaimed. Utilizing the compacting feature in BreeZ v6 or later allows full usage of a gateway's available RF Host address space and should be done prior to updating or programming any transmitters and deploying a system.

 After modifying a gateway's RF Host address space, the gateway and all affected transmitters must be updated to ensure proper communication with the gateway.

- i. This feature can be accessed by double-clicking on the desired gateway in the project tree, then clicking on the **Gateway** tab.
- j. The table below shows that it is missing the host address 03.

Nodes	07
LiqLevel-Res	01
LiqLevel-Hyd	02
Analog	04
LiqLevel-Ult	05
WDIOModule	06
IO MAX	07
RTD	08
Next Available	09

- k. Right-click over the row, **RF Nodes**, and select **Compact RF Host Addressing**.

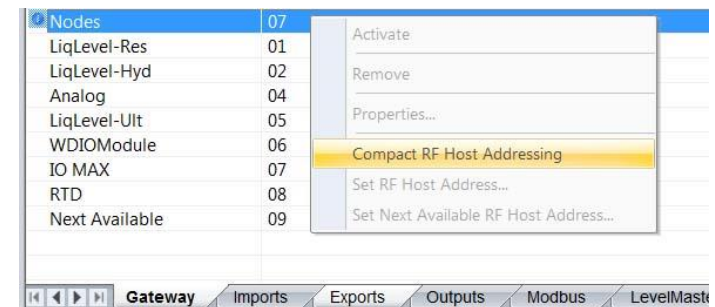

Nodes	07
LiqLevel-Res	01
LiqLevel-Hyd	02
Analog	04
LiqLevel-Ult	05
WDIOModule	06
IO MAX	07
RTD	08
Next Available	09

- l. Address gaps in the table are removed after the compaction.

Nodes	07
LiqLevel-Res	01
LiqLevel-Hyd	02
Analog	03
LiqLevel-Ult	04
WDIOModule	05
IO MAX	06
RTD	07
Next Available	08

2. Ability to modify a transmitter’s RF Host address.

This feature allows you to manage the RF Host address of each individual transmitter.

- a. This feature can be accessed by double-clicking on the desired gateway in the project tree, then clicking on the **Gateway** tab.
- b. Right-click over the desired transmitter and select **Set RF Host Address...**

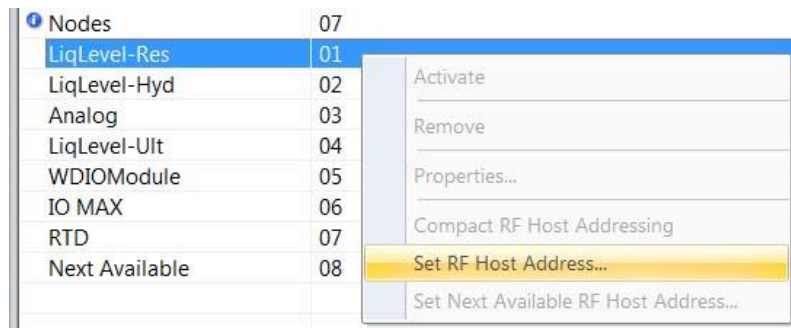

- c. Edit the **RF Host Address**.

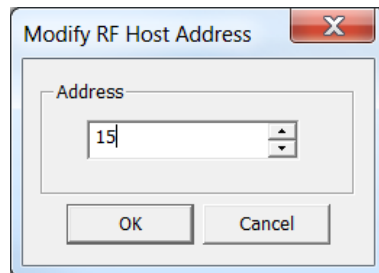

- d. Reassigned RF Host Address is shown below.

Nodes	07
LiqLevel-Res	15
LiqLevel-Hyd	02
Analog	03
LiqLevel-Ult	04
WDIOModule	05
IO MAX	06
RTD	07
Next Available	08



Be sure not to have duplicates, configuring multiple transmitters with the same RF Host Address may lead to unintended results.

Nodes	07
LiqLevel-Res	15
LiqLevel-Hyd	15
Analog	03
LiqLevel-Ult	04
WDIOModule	05
IO MAX	06
RTD	07
Next Available	08

18. HOW TO PROGRAM/UPDATE THE GATEWAY

The DH2-W can be updated or “programmed” using the SX1000-CC2 All-in-One Configuration Cable.

1. Supply power to the gateway (9-30 Vdc).
2. Connect the PC to the gateway using the SX1000-CC2 cable.

- a. Connect the grey USB end of the SX1000-CC2 cable to the PC.



- b. Connect the grey Mini-USB end of the SX1000-CC2 cable to the gateway’s configuration port.



3. Program/update the gateway.

- a. Click on the gateway in the project tree.
- b. Click the **Update Device** button .

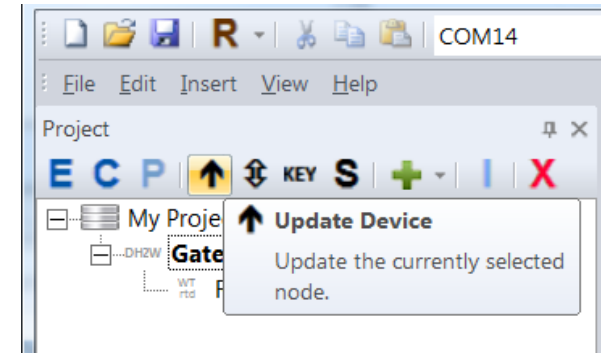

- c. If the gateway was used with another project file, the Site Security Mismatch window will appear.
 - i. Click the **Update Key** to proceed with the new project.

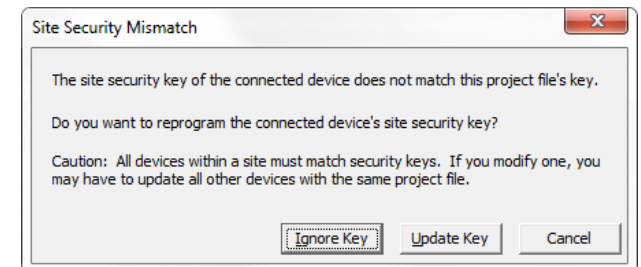

- d. After updating the gateway, the current project file will automatically be saved to the gateway for file retrieval purposes.

The **Auto-Upload** settings can be managed under the **Edit – Options** menu.

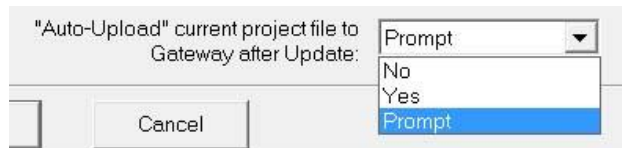

- e. Check the **Output Build** tab window for verification of the update.

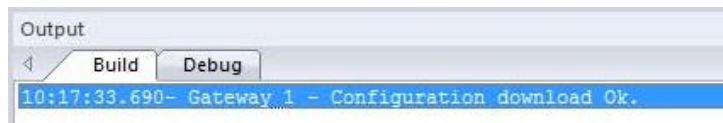

Anytime a project file is modified, the impacted device(s) must be updated.

19. CONNECTING TO THE GATEWAY VIA THE SOFTWARE

When a gateway is connected to the BreeZ Software, users can also directly access the settings stored on the device. Once connected, there are a variety of actions that can be performed like upgrading the firmware.

1. Supply power to the gateway.
2. Connect the PC to the gateway.
3. Open the BreeZ project file.
4. Click on the gateway in project tree and click the **Connect to Device** button.

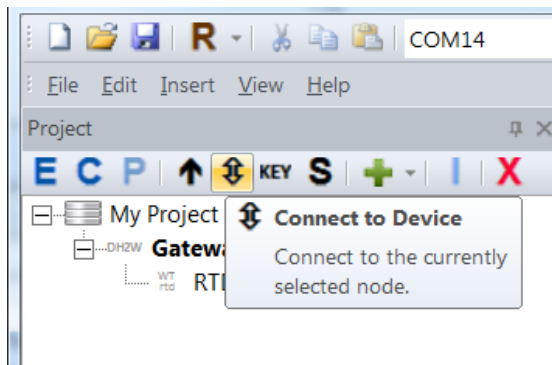

5. Device Tab

- a. Displays how the device is set up.
- b. Displays firmware version.
- c. Displays RF security settings.

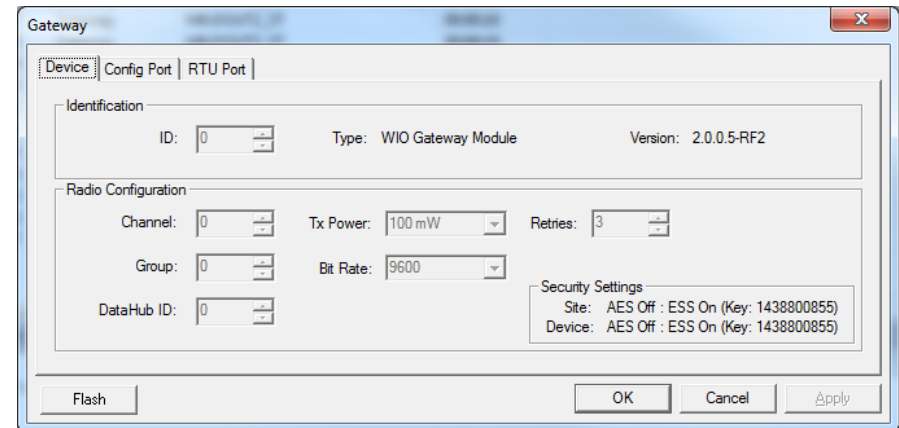

6. RTU Port Tab

- a. Displays how the RTU Serial Port is set up.

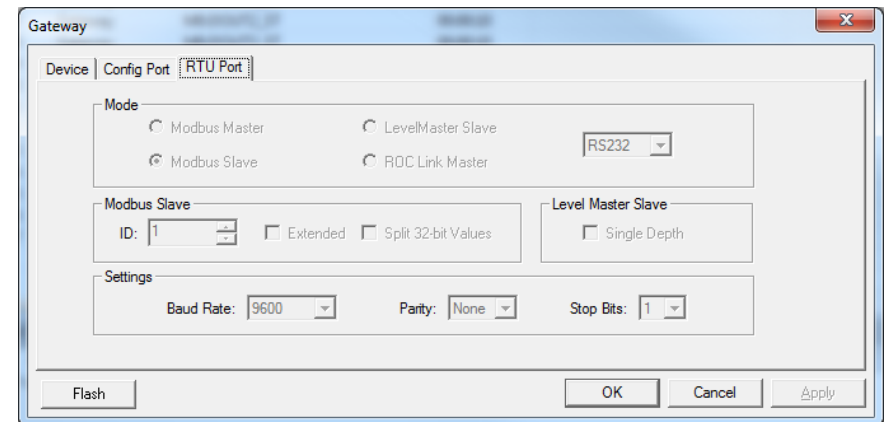

7. Config Port Tab

- a. Displays how the Configuration Port is set up.

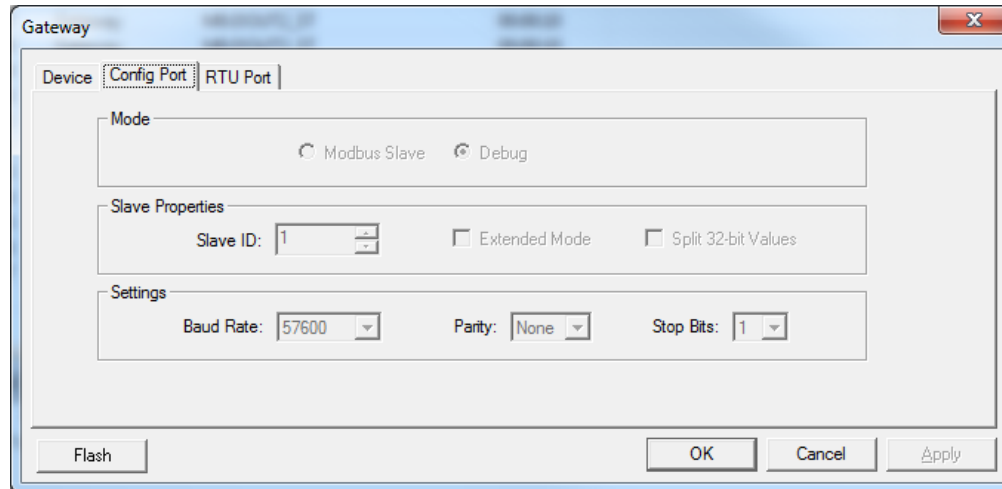

The screenshot shows the 'Gateway' configuration window with the 'Config Port' tab selected. The window contains the following settings:

- Device:** Config Port (selected), RTU Port
- Mode:** Modbus Slave, Debug
- Slave Properties:** Slave ID: 1, Extended Mode, Split 32-bit Values
- Settings:** Baud Rate: 57600, Parity: None, Stop Bits: 1

Buttons at the bottom: Flash, OK, Cancel, Apply.

20. HOW TO UPGRADE THE GATEWAY FIRMWARE

1. Supply power to the gateway (9-30 Vdc).



DO NOT remove power from the device while a firmware upgrade is in progress.

2. Connect the PC to the gateway using the SX1000-CC2 cable.

3. Select the correct COM port.

4. Upgrade the gateway firmware.

- a. Download the latest gateway firmware from the OTC Download Center. <http://support.oleumtech.com>
- b. Click on the gateway in the project tree.
- c. Click the **Connect to Device** button.

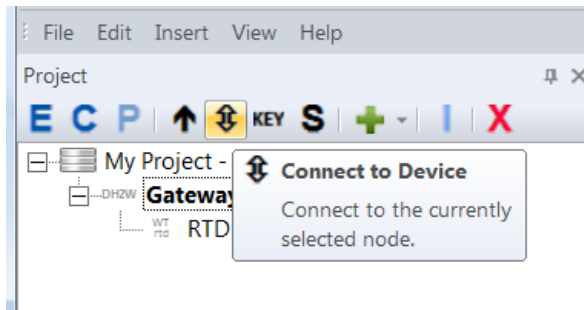

- d. Click **Flash** button to begin the firmware upgrade process.

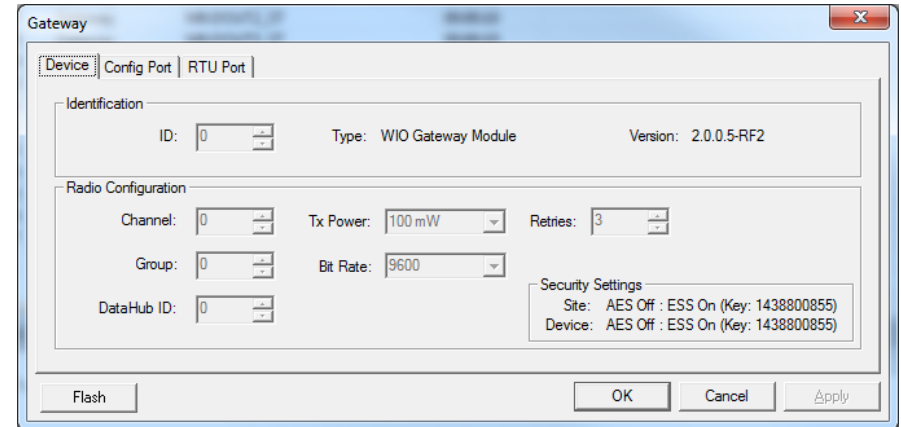

5. The project file will be retained on the gateway after the firmware upgrade process.

21. POLLING MODBUS REGISTERS USING THE SOFTWARE

The BreeZ Software provides you with the ability to poll the gateway’s Modbus registers for installation verification and troubleshooting purposes.

 The gateway’s Config Port must be setup in Modbus Slave mode.

 This feature allows users to take a poll once per command. Continuous polling is not available.

Single, multiple, or all registers can be selected for polling.

Use registers such as Battery Voltage, RF timeout, RF refresh, and RSSI values to determine device and network health.

1. Supply power to the gateway (9-30 Vdc).
2. Connect the PC to the gateway using the SX1000-CC2 cable.
3. Open the BreeZ project file.
4. Select the correct COM port.
5. Click on the gateway in the project tree.
6. Verify the gateway’s Config port is set up in Modbus Slave mode.
 - a. Click the **Connect to Device** button .

- b. Click on the **Config Port** tab.

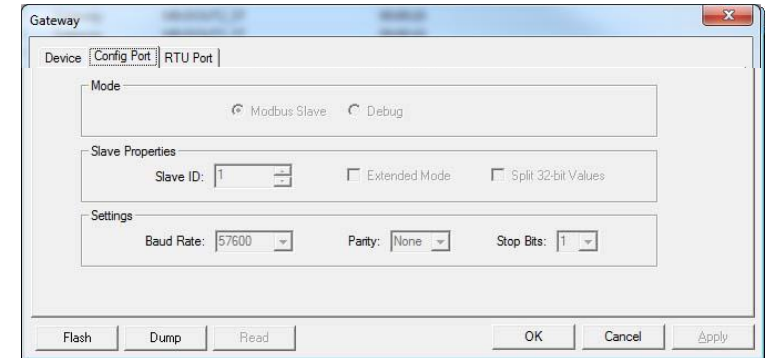

- c. Verify that the gateway is in the Modbus Slave mode.

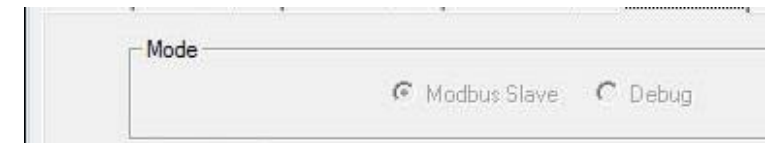

7. If the gateway is not in the Modbus Slave mode, then:
 - a. Click Cancel to exit the screen.
 - b. Click on the gateway in the project tree.
 - c. Click the **E Edit** button.
 - d. Click on the **Config Port** tab.
 - e. Change the mode to **Modbus Slave**.
 - f. Click **OK**.
 - g. Click the **Update Device** button .

8. Double-click on the gateway in the project tree.

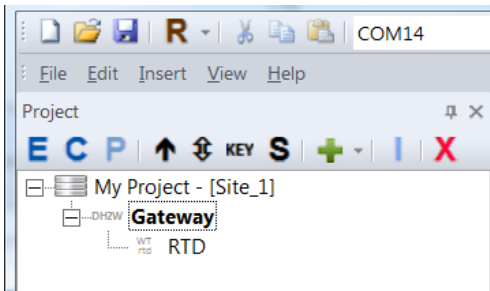

9. Click on the Modbus tab.

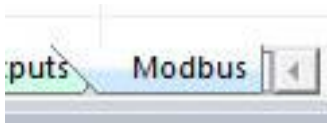

10. Select the desired registers to be polled.

11. Right-Click over highlighted area and select Poll Modbus Register(s).

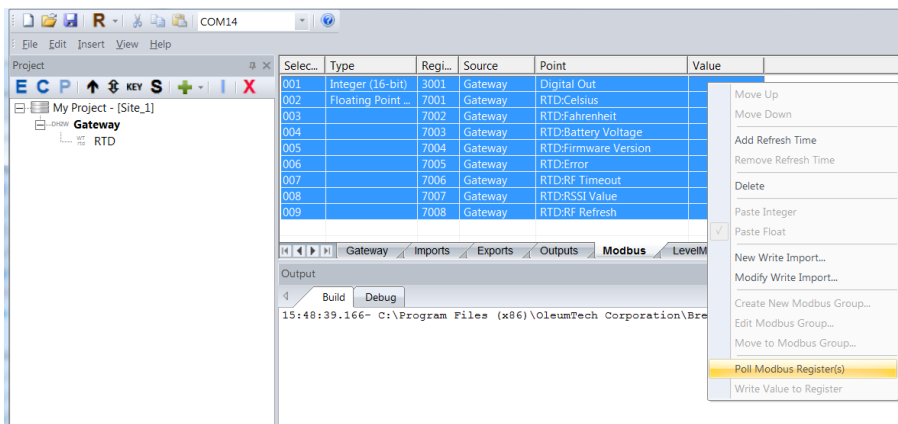

12. View the Value column for data updates.

Select All	Type	Register	Source	Point	Value
001	Floating Point (32-bit)	7001	Gateway	RTD:Fahrenheit	70.8461
002		7002	Gateway	RTD:Celsius	21.5812
003		7003	Gateway	RTD:Battery Voltage	3.2190
004		7004	Gateway	RTD:RF Timeout	0.0000

13. Troubleshooting

- a. "-" indicates that the Modbus read is failing. Ensure the gateway's Config Port is set to the Modbus Slave mode.

Select All	Type	Register	Source	Point	Value
001	Floating Point (32-bit)	7001	Base Unit	MBModule:Point_1	--
002		7002	Base Unit	MBModule:Point_2	--
003		7003	Base Unit	MBModule:Point_3	--

22. DEBUG SESSION

The gateway’s Debug screen provides a great level of detail on the gateway’s activities that can be utilized for both device and system diagnostics.

To view the Debug output, the gateway’s Config port must be configured to Debug mode. If the port is set as a Modbus Slave, the Debug function is not available.

1. Click on the **Output Debug** tab to view gateway’s activities.

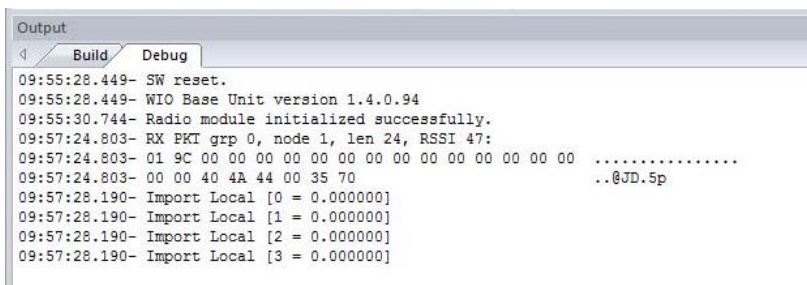

2. **Auto Scroll** option.

The Debug screen’s default mode of operation is Auto Scroll. To freeze on specific events, use the manual scrolling option by unchecking the Auto Scroll. To do so, right-click over the Debug screen to edit the setting.

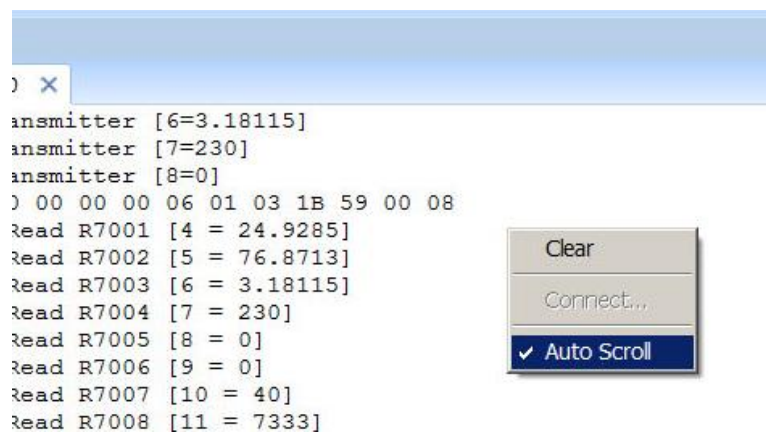

3. Debug Messages/Troubleshooting

Click the link below to download the reference table for various debug messages.

<http://support.oleumtech.com/wp-content/uploads/downloads/user-guides/oleumtech-wireless-gateways-debug-messages.pdf>

23. RF REFRESH TIME TAG(S)

Adding an RF Refresh Time tag to any Modbus point ensures the data that is held in the Modbus table is valid. When the RF Refresh tag is used for trending, a normal graph will look like a sawtooth wave.

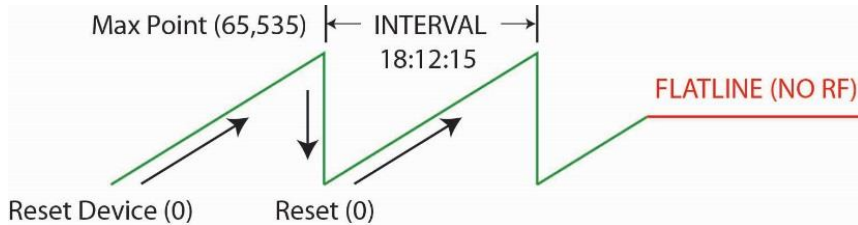

1. Double-click on the DH2-W in the project tree.
2. Click the **Modbus** tab.
3. Select a point, right-click on it and select **Add Refresh Time**.

Register	Source	Point	Value
7005	Gateway	RTD:RF Refresh	64666.0000
7006	Gateway	RTD>Error	0.0000
7007	Gateway	Base:VIN	12.3412
7008	Gateway	Base:LogStatus	1.0000
7009	Base Unit	Base:AIN1	0.0000
7010	Base Unit	Base:AIN2	0.0000
7011	Base Unit	Base:AIN3	0.0154
7012	Base Unit	Base:AIN4	0.0000
7013	Base Unit	Base:DIN1	0.0000
7014	Base Unit	Base:DIN2	0.0000

Move Up

Move Down

Add Refresh Time

Remove Refresh Time

Delete

4. Save the project file and update the gateway for changes to take effect.

5. Poll the Modbus register to verify refresh count.

- a. Refresh count moves in 1 second increments.
 - i. If the Tx interval is 60 seconds, the RF refresh count will jump in increments of 60.

Register	Source	Point	Value
7006	Gateway	RTD>Error	0.0000
7007	Gateway	Base:VIN	12.2345
7008	Gateway	Base:LogStatus	1.0000
7009	Base Unit	Base:AIN1	0.0000
7010	Base Unit	Base:AIN1:Refresh	64848.0000
7011	Base Unit	Base:AIN2	0.0000
7012	Base Unit	Base:AIN3	0.0000

24. PEER-TO-PEER/REPEATER/SHARING DATA

The OTC Wireless Sensor and I/O Network is extremely flexible by allowing any tags to be shared across multiple wireless gateways in a single wireless network, adding an incredible amount of flexibility and agility to the system.

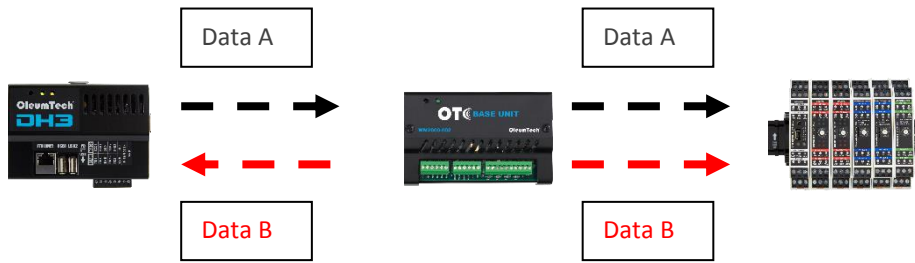

The DH2-W supports up to 1920 points for peer-to-peer application.

The transmit interval, bit rate, environment, and number of interfering transmitters play a significant factor in actual RF throughput and peering capabilities.

1. Click on **Site** in the project tree and add another wireless gateway.

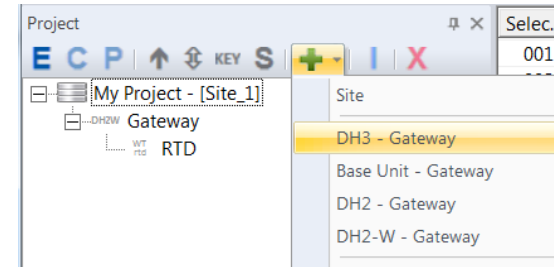

2. Select a point(s) available in the **Import** tab from the gateway (origin) to share with another gateway.

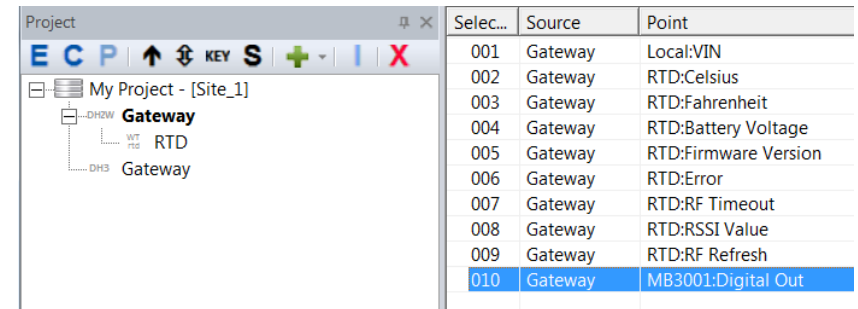

3. Select the gateway (destination) in the project tree you wish to relay the point(s) to.

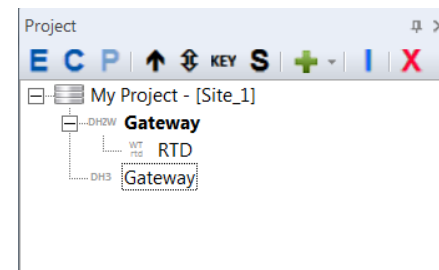

4. Click the **I** button – **Import Points** function.

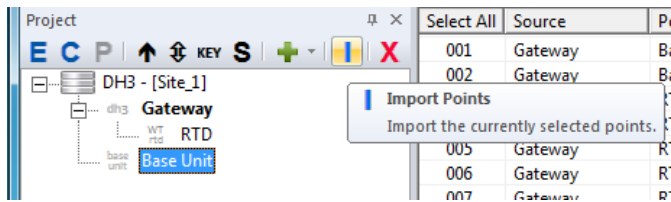

5. Check **Map To** Integer Table or Floating Point Table or both.

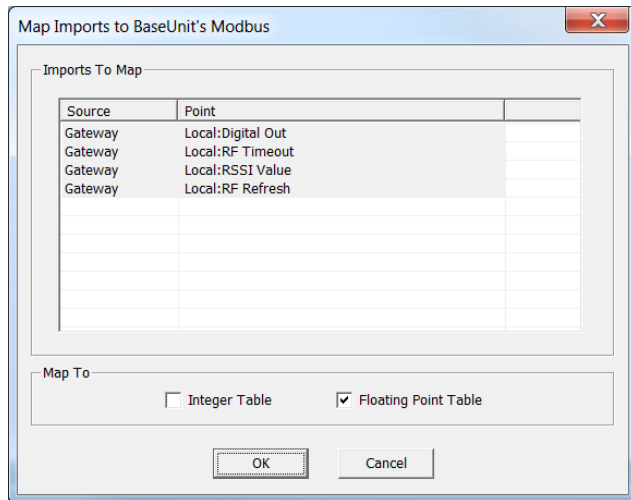

6. Double-click on the destination gateway.

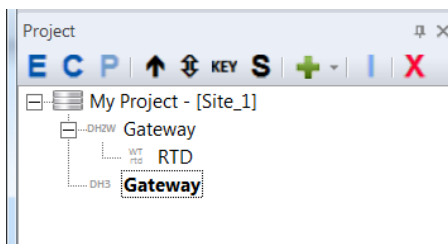

7. Click on the **Imports** tab to confirm the point(s) was shared.

Selec...	Source	Point	Interval	Scaling
001	Gateway	Local:VIN	00:01:00	
002	Gateway	Local:LogStatus	On Change	
003	Gateway	Local:TrendStatus	On Change	
004	Gateway	MB3001:Digital Out	On Change	Gain = 1.0000
005	Gateway	Local:RF Timeout	00:15:00	
006	Gateway	Local:RSSI Value	On Change	
007	Gateway	Local:RF Refresh	On Change	

8. The point(s) is automatically mapped to its Modbus register holding table on the destination gateway.

Selec...	Type	Regi...	Source	Point	Value
001	Floating Point ...	7001	Gateway	Local:Digital Out	
002		7002	Gateway	Local:RF Timeout	
003		7003	Gateway	Local:RSSI Value	
004		7004	Gateway	Local:RF Refresh	

9. Gateway RF Health Tags

- a. When initiating the Import function, 3 new RF health tags will be added to the Imports table on the destination gateway. These tags are designed to monitor the RF health of the gateway to gateway communication.



1. RF Timeout
2. RSS Value
3. RF Refresh

Imports To Map	
Source	Point
Gateway	Local:Digital Out
Gateway	Local:RF Timeout
Gateway	Local:RSSI Value
Gateway	Local:RF Refresh

 Any local RF health tags that are removed from the Imports table cannot be restored, unless if you do the following:

The only way to restore the RF tags is by removing all three RF health tags together from the Import table, then repeating step 3 to 6 from this section. Then any unneeded or duplicate points can be removed from the Imports table.

007	Gateway	MB3001:Digital Out	On Change	Gain = 1.0000
008	Gateway	Local:RF Timeout	00:15:00	
009	Gateway	Local:RSSI Value	On Change	
010	Gateway	Local:RF Refresh	On Change	

-  Remove Shared Point Ctrl+X
-  Copy Ctrl+C
- Paste to Integer Table
- Paste to Float Table

- b. The gateway RF Timeout duration must be longer than the shortest reporting interval from the gateway of origin to avoid falsely triggering a RF timeout.

e.g.: If the RF timeout is set to 15 minutes, but the shortest reporting interval from the origination Gateway is 30 minutes, then the gateway will report a false RF timeout.

To change the RF timeout interval, access the property settings of the origination gateway, click on the Radio tab, and change the **Node Timeout** duration.

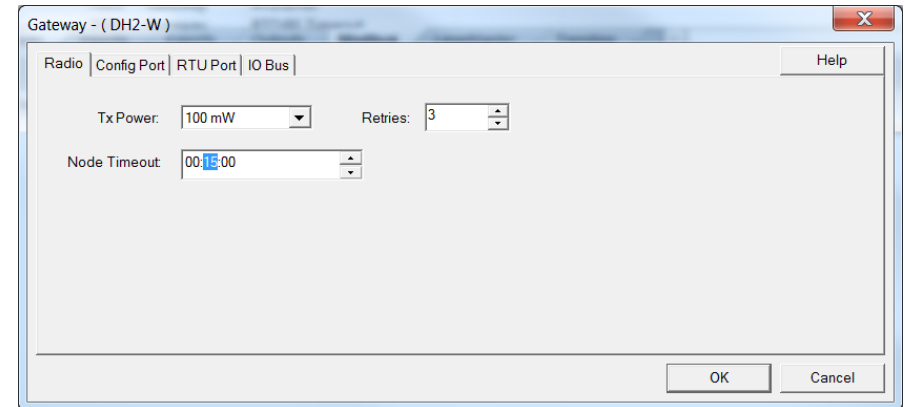

- c. The gateway RF Health tags cannot be peered more than once or re-shared or imported to another Gateway.
 - i. When attempting to use the Import functions, these tags will simply be disregarded.

10. Using a shared point based on interval or on change.

- a. Double-click on the primary gateway in the project tree.
- b. Click on the **Exports** tab.
- c. Right-click on the point and select **Interval**.

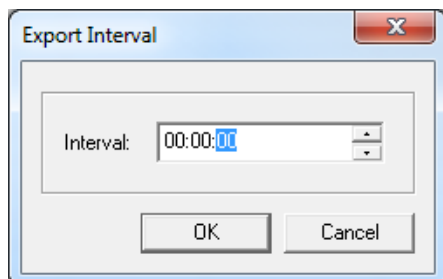
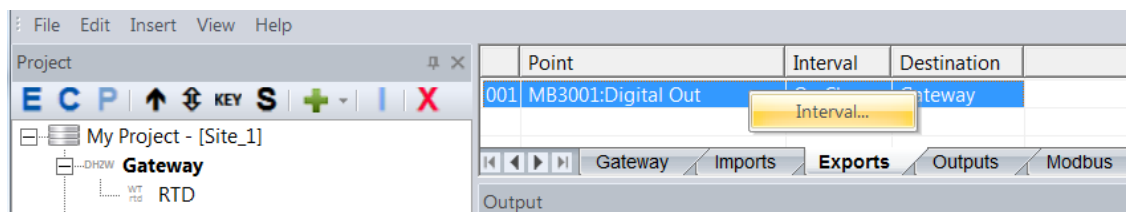

- d. If the **Interval** is set to 0, then the data will be transmitted when there is a change in value.
- e. If the **Interval** is non-zero, then the gateway will send the data at the configured time interval (HH:MM:SS).

11. Save the project file.

12. Update both gateways for the changes to take effect.

25. MODBUS MASTER FUNCTION

The gateway can be configured as a Modbus Master through its Serial port.

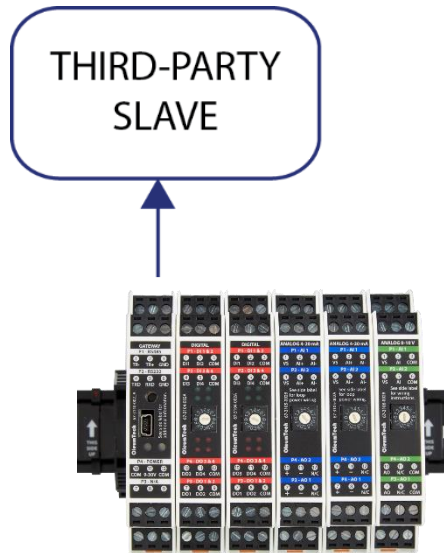

Supported Modbus Function Codes

1. Read Holding Registers – FC3, int16, float
2. Read Input Registers – FC4, int16
3. Write Single Holding Register – FC6, int16, float

1. Access the gateway's properties by clicking the **E** button or right-clicking and selecting **Edit**.

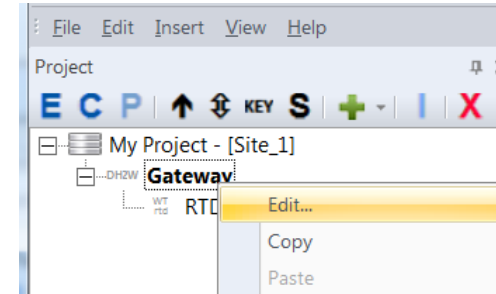

2. RTU port method

- a. Click on the **RTU Port** tab.
- b. Select the **Modbus Master** for mode of operation.
- c. Set the port as **RS232** or **RS485**.

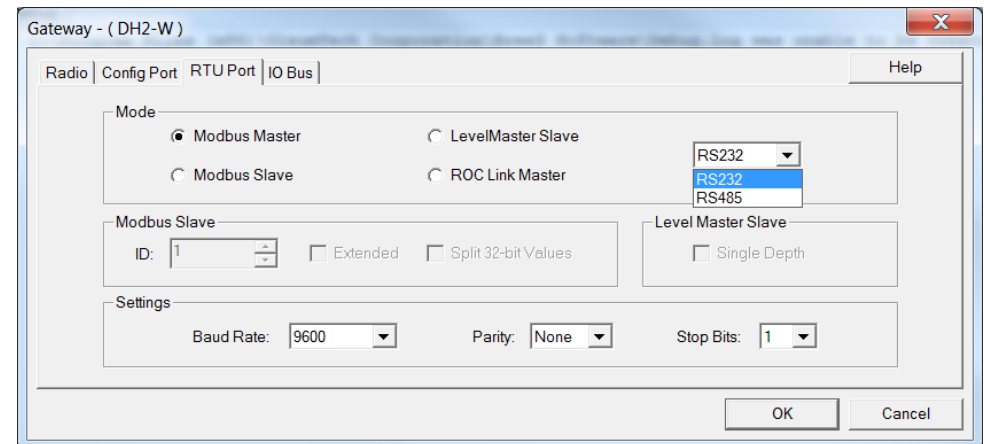

- Click on the gateway in project tree and click the **+ Insert Device** button and select **Modbus Module**.

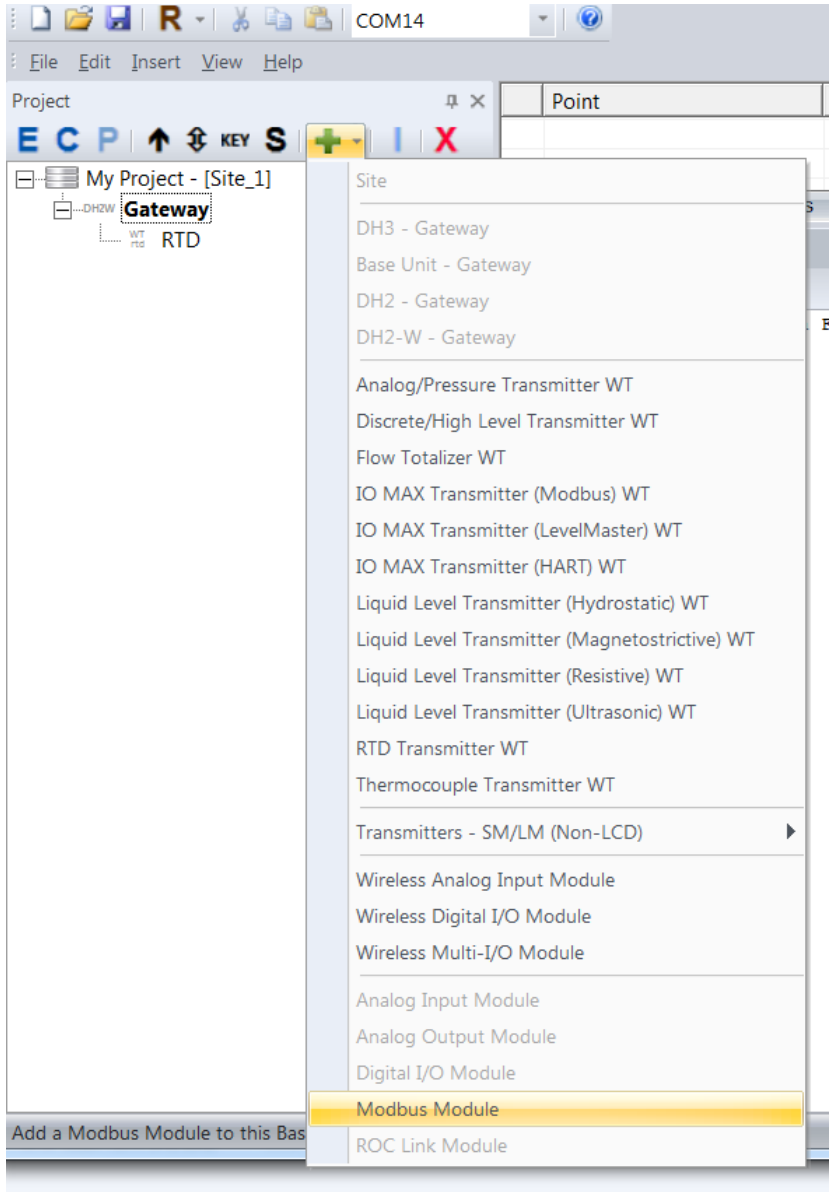

- Under the **IO Bus** tab, select the **Slave ID**.

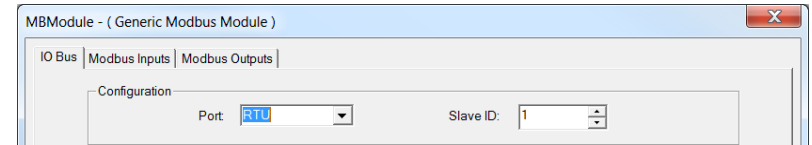

- To schedule a Modbus read function, click the **Modbus Inputs** tab and configure the input settings.

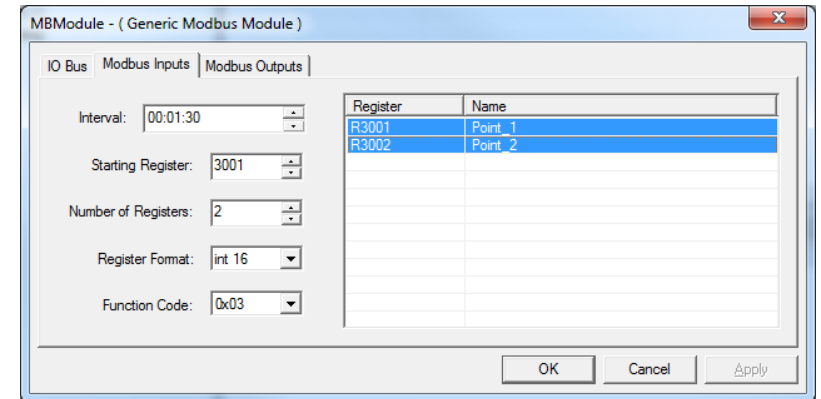

- To schedule Modbus write function(s), click the **Modbus Outputs** tab and configure the output settings.

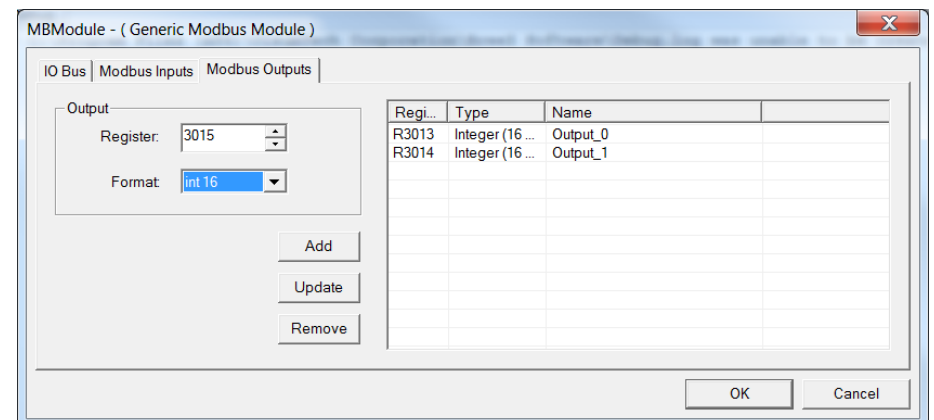

7. How to map the imported points to the gateway's Modbus register holding table.

- a. Double-click on the gateway in the project tree.
- b. Click the **Imports** tab.
- c. Right-click over the imported points and select **Paste to Integer Table** or **Paste to Float Table**.

Select All	Source	Point	Interval	Scaling
001	Gateway	0-10 V Slave 1:Point_1	00:01:30	Gain = 1.0000
002	Gateway	0-10 V Slave 1:Point_2	00:01:30	Gain = 1.0000

- d. Select the **Modbus** tab and verify the Modbus register mapping.

Select All	Type	Register	Source	Point
001	Floating Point (32-...	7001	Gateway	0-10 V Slave 1:Point_1
002		7002	Gateway	0-10 V Slave 1:Point_2

8. How to allow a RTU (Modbus Master) to write Module Outputs to a third-party Modbus Master device.

- a. Double-click on the gateway in the project tree.
- b. Select the **Modbus** tab.
- c. Right-click in the Modbus window, and select **New Write Import**.

Select All	Type	Register	Source	Point	Value
001	Floating Point (32-...	7001	Gateway	0-10 V Slave 1:Point_1	
002		7002	Gateway	0-10 V Slave 1:Point_2	

- d. Create a **Name** for the write command and select **Integer** or **Float**.

Write Import ✕

Command

Name:

Type: Integer Float

- e. Select the **Imports** tab and right-click on the newly created Write command and select **Copy**.

Select All	Source	Point	Interval	Scaling
001	Gateway	0-10 V Slave 1:Point_1	00:01:30	Gain = 1.0000
002	Gateway	0-10 V Slave 1:Point_2	00:01:30	Gain = 1.0000
003	Gateway	MB3001:Write	On Change	

- Remove Shared Point Ctrl+X
- Copy** Ctrl+C
- Paste to Integer Table
- Paste to Float Table
- Scaling...
- Logging...

Gateway Imports Exports Outputs Modbus LevelMaster

- f. Select the **Outputs** tab and right-click on an output point and select **Paste Output Source**.

	Output	Source	Point
001	0-10 V Slave 1:Output_1		
002	0-10 V Slave 1:Output_1		

- Paste Output Source**
- Remove Output Source

	Output	Source	Point
001	0-10 V Slave 1:Output_1	Gateway	MB3001:Write
002	0-10 V Slave 1:Output_1		

- g. Save the project file.
- h. Update the gateway for the changes to take effect.

26. I/O EXPANSION CAPABILITIES

The OleumTech RS485 I/O Modules can easily be integrated with the DH2-W by configuring the system in the BreeZ Software without having to sacrifice its Serial port. Any I/O module added to a DH2-W becomes an extension of the DH2-W. Thus, the I/O points are accessible through gateway's properties under Imports and Outputs.

1. Access the gateway properties window.

- a. Click on the gateway in the project tree, right-click over it and select **Edit** or click on the **E** button.

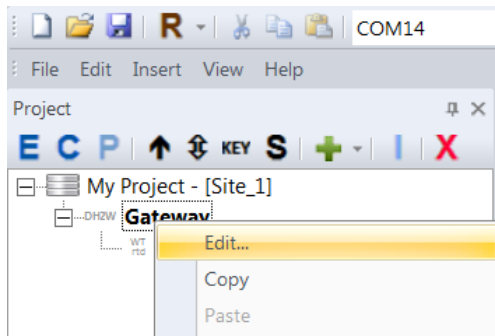

2. Click the I/O Bus tab.

- a. Click **New**.

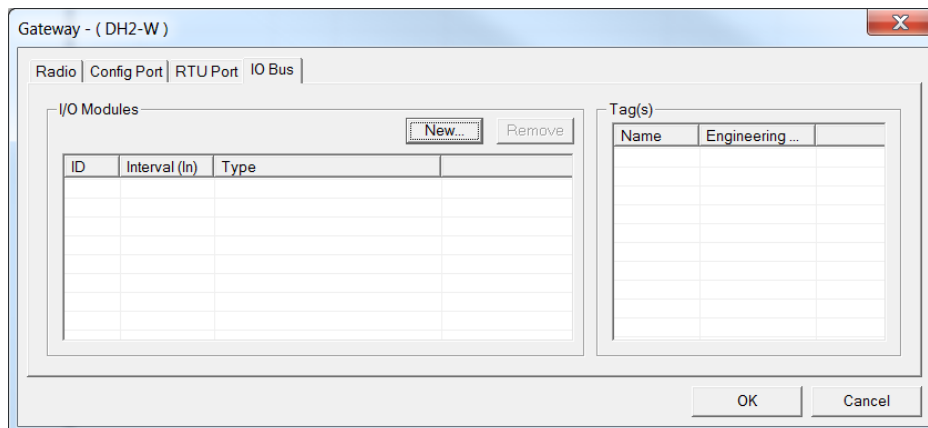

b. Select the desired I/O Module.

- a. **0-10 V**: 2 In and 2 Out (Isolated)
- b. **4-20 mA**: 2 In and 2 Out (Isolated)
- c. **Digital**: 4 In and 4 Out (Isolated)

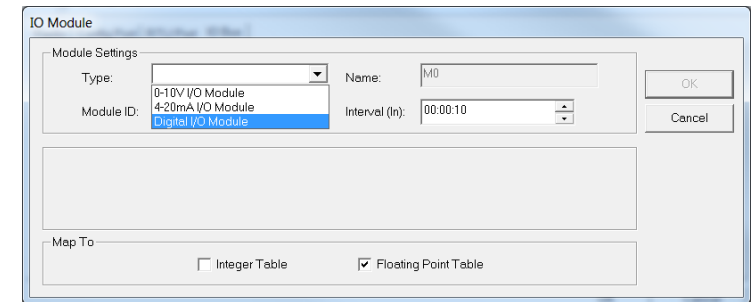

Note: The device ID selected in the software must match the number position set on the rotary dial switch.

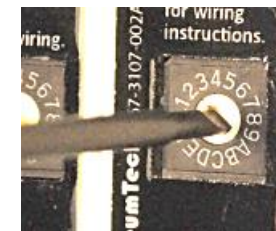

3. Digital I/O Module

- a. **Name:** create a name.
- b. Set the **Module ID**.
- c. Set the read **Interval** (Outputs are based on change and not interval)
- d. **Add to Imports Table:**
 - i. Inputs
 - ii. Counts
 - iii. Output status (on/off)
- e. **Map To:** Add the points to the Modbus table as Integers (16-bit), Floating Points (32-bit), or both.

4. 4-20 mA I/O Module

- a. **Name:** create a name.
- b. Set the **Module ID**.
- c. Set the read **Interval** (Outputs are based on change and not interval)
- d. **Engineering Units**
 - i. Select the desired settings for both **Input 1 and 2**
 1. mA * 1000 (20,000)
 2. 4.0 to 20.0 mA
 - ii. Select the desired settings for **Output 1**
 1. mA * 1000 (20,000)
 2. % *100(10,000)
 3. 4.0 to 20.0 mA
 4. 0.0-100.0%
 - iii. Select the desired settings for **Output 2**
 1. mA * 1000 (20,000)
 2. % *100(10,000)
 3. 4.0 to 20.0 mA
 4. 0.0-100.0%
- e. **Map To:** Add the points to the Modbus table as Integers (16-bit), Floating Points (32-bit), or both.

5. 0-10 V I/O Module

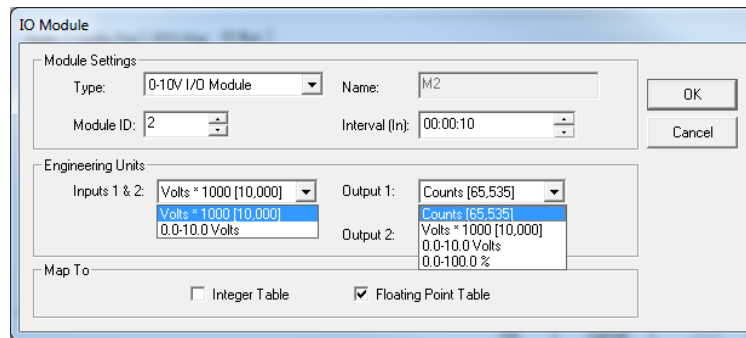

- a. **Name:** create a name.
- b. Set the **Module ID**.
- c. Set the read **Interval** (Outputs are based on change and not interval)
- d. **Engineering Units**
 - i. Select the desired settings for **Input 1 and 2**
 1. Volts * 1000 (10,000)
 2. 0.0 to 10.0 Volts
 - ii. Select the desired settings for **Output 1**
 1. Counts (65,535)
 2. Volts * 1000 (10,000)
 3. 0.0-10.0 Volts
 4. 0.0-100.0%
 - iii. Select the desired settings for **Output 2**
 1. Counts (65,535)
 2. Volts * 1000 (10,000)
 3. 0.0-10.0 Volts
 4. 0.0-100.0%
- f. **Map To:** Add the points to the Modbus table as Integers (16-bit), Floating Points (32-bit), or both.

6. Verify the input points.

- a. Double-click on the gateway in the project tree.
- b. Click on the **Imports** tab to verify the available inputs.

Selec...	Source	Point	Interval	Scaling
001	Gateway	Local:VIN	00:01:00	
002	Gateway	M0:DIN1	00:00:10	
003	Gateway	M0:DIN2	00:00:10	
004	Gateway	M0:DIN3	00:00:10	
005	Gateway	M0:DIN4	00:00:10	
006	Gateway	M1:AIN1	00:00:10	
007	Gateway	M1:AIN2	00:00:10	
008	Gateway	M2:AIN1	00:00:10	
009	Gateway	M2:AIN2	00:00:10	

- c. Click on the **Modbus** tab to verify the points were added to the table properly.

Selec...	Type	Regi...	Source	Point	Value
001	Floating Point ...	7001	Gateway	M0:DIN1	
002		7002	Gateway	M0:DIN2	
003		7003	Gateway	M0:DIN3	
004		7004	Gateway	M0:DIN4	
005		7005	Gateway	M1:AIN1	
006		7006	Gateway	M1:AIN2	
007		7007	Gateway	M2:AIN1	
008		7008	Gateway	M2:AIN2	

7. Save the project file.

8. Update the gateway for changes to take effect.

27. I/O MAPPING (MODBUS WRITE FUNCTION AND MAPPING IT TO THE GATEWAY'S OUTPUT)

In order to relay data or map I/O points together from a third-party Modbus Master device to a point or output on the OTC Wireless Sensor and I/O Network, a Modbus Write function must be created in the gateway's Modbus table. Once the function is created, then the write import point can be mapped to an output or shared with another device within the network.

Multiple Master devices writing to the same Modbus holding register(s) provide unpredictable results.



Be sure to set the appropriate RTU Port Mode to Modbus Slave for Serial operation.

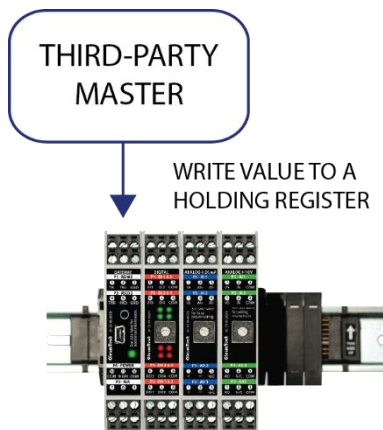

1. Double-click on the gateway in project tree.

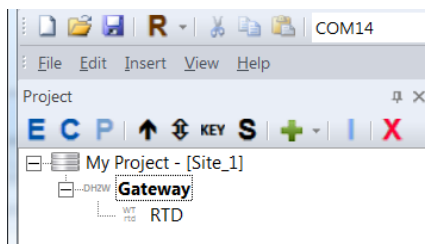

2. Click on the **Modbus** tab.

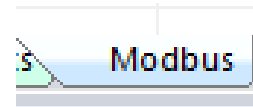

3. Right-click inside Modbus window and select **New Write Import**.

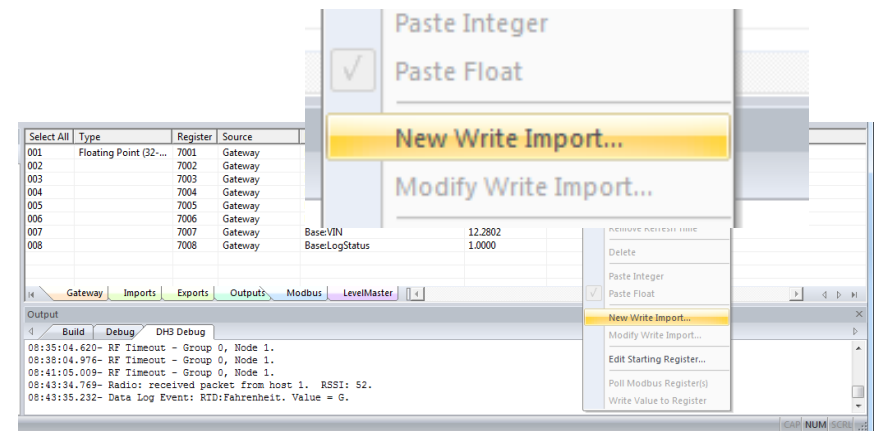

4. Provide a **Name** for the function and select the point as an **Integer** or **Float**.

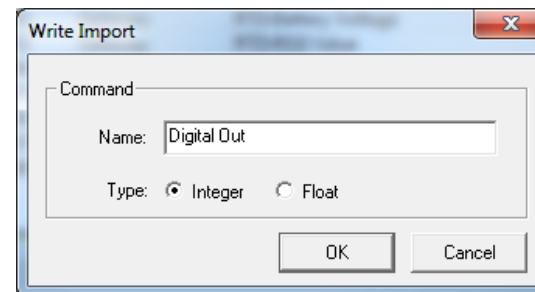

5. The point will be added to the Modbus table.

Select All	Type	Register	Source	Point
001	Integer (16-bit)	3001	Gateway	Digital Out
002	Floating Point (32-...	7001	Gateway	RTD:Fahrenheit
003		7002	Gateway	RTD:Battery Voltage
004		7003	Gateway	RTD:RSSI Value
005		7004	Gateway	RTD:RF Timeout

6. Map the Write Import to an output.

- a. Click on the **Imports** tab and right-click on the newly created **Write** command and select **Copy**.

Select All	Source	Point	Interval	Scaling
001	Gateway	Base:VIN	00:00:01	
002	Gateway	RTD:Fahrenheit	00:15:00	Gain = 1.0000
003	Gateway	RTD:Celsius	00:15:00	Gain = 1.0000
004	Gateway	RTD:Battery Voltage	00:15:00	Gain = 1.0000
005	Gateway	RTD:RF Timeout	00:45:00	
006	Gateway	RTD:RSSI Value	00:15:00	
007	Gateway	RTD:RF Refresh	00:15:00	
008	Gateway	WIOModule:DM1_DIN1	00:00:10	Gain = 1.0000
009	Gateway	WIOModule:DM1_DIN2	00:00:10	Gain = 1.0000
010	Gateway	WIOModule:DM1_DIN3	00:00:10	Gain = 1.0000
011	Gateway	WIOModule:DM1_DIN4	00:00:10	Gain = 1.0000
012	Gateway	WIOModule_2:AM2_AIN1	00:00:10	Gain = 1.0000
013	Gateway	WIOModule_2:AM2_AIN2	00:00:10	Gain = 1.0000
014	Gateway	WIOModule_3:AM1_AIN1	00:00:10	Gain = 1.0000
015	Gateway	WIOModule_3:AM1_AIN2	00:00:10	Gain = 1.0000
016	Gateway	MB3001:DO1	On Change	

Remove Shared Point Ctrl+X
Copy Ctrl+C

- b. Click the **Outputs** tab and right-click on the desired output point and select **Paste Output Source**. (See previous section for adding outputs)

	Output	Interval	Source	Point
001	WIOModule:DM1_DOUT1			
002	WIOModule:DM1_DOUT2			
003	WIOModule:DM1_DOUT3			
004	WIOModule:DM1_DOUT4			
005	WIOModule_2:AM2_AOUT1			
006	WIOModule_2:AM2_AOUT2			
007	WIOModule_3:AM1_AOUT1			
008	WIOModule_3:AM1_AOUT2			

Paste Output Source
 Remove Output Source
 Interval...

	Output	Interval	Source	Point
001	WIOModule:DM1_DOUT1	Gateway	MB3001:DO1	
002	WIOModule:DM1_DOUT2			

7. Save the project file.

8. Update the gateway for the changes to take effect.

9. Write a value from a Modbus Master device.

- a. Values must be written as either 16 or 32-bit holding registers.

10. Verify the I/O mapping execution.

- a. Verify the responding behavior of the output.
- b. Poll the Modbus register to verify the execution of the Modbus Write. (The gateway must in Modbus Slave mode).

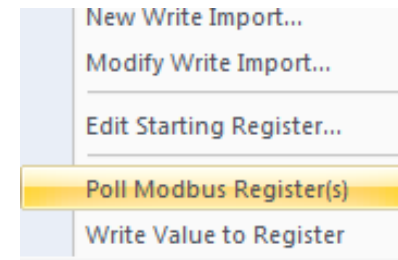

Point	Value
Digital Out	1
RTD:Fahrenheit	71.8316

28. MAPPING AN IMPORT POINT TO ANOTHER GATEWAY'S OUTPUT

In the OTC Wireless I/O and Sensor Network, any import point can be mapped to an available output in the same network whether it be to a DH1 Base Unit, Wireless Multi-I/O Module, or another device with an output as long as the I/O mapping route through the network is reachable over-the-air.

An import point can also be a function created by a Modbus Write function so that the point can be written by a third-party Master device such a RTU or PLC.

The I/O mapping instructions will be shown using a DH3 and a DH2-W.

1. Create a Modbus Write function on the DH3.

Select All	Type	Register	Source	Point
001	Integer (16-bit)	3001	Gateway	Digital Out
002	Floating Point (32-...	7001	Gateway	RTD:Fahrenheit
003		7002	Gateway	RTD:Battery Voltage
004		7003	Gateway	RTD:RSSI Value
005		7004	Gateway	RTD:RF Timeout

2. Share the Import point from the DH3 to the DH2-W using the peer-to-peer function.

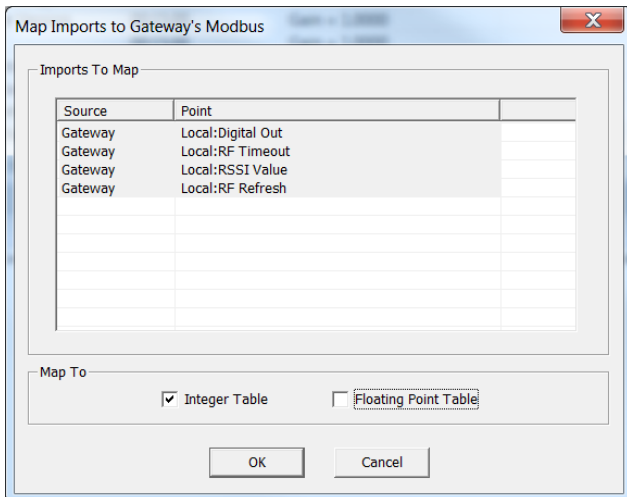

3. Double-click on the Base Unit in the project tree.

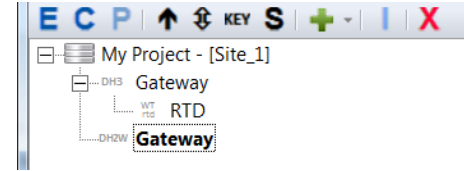

4. Right-click on the desired Import point and select Copy.

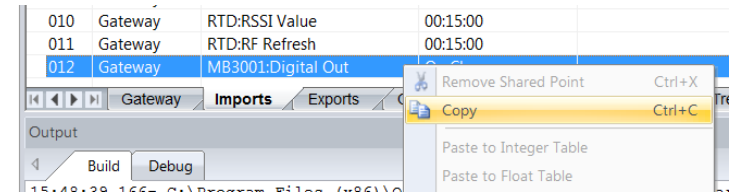

5. Click on the Outputs tab.

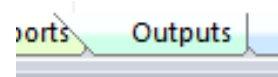

6. Right-click over the desired output target and select Paste Output Source.

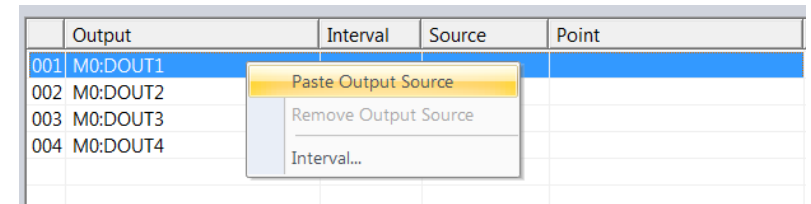

Output	Interval	Source	Point
001	M0:DOUT1	Gateway	MB3001:Digital Out
002	M0:DOUT2		
003	M0:DOUT3		
004	M0:DOUT4		

7. Save the project file and update both gateways for changes to take effect.

29. ROC LINK MASTER

The gateway can be configured as a ROC Link Master through the Serial/RTU.

It supports two Opcodes

Opcode 17: login request

Opcode 10: read configurable opcode data

1. Allows user to read up to 10 user configurable (TLP) points from a ROC.
2. Points can be a mix of type INT16 (signed or unsigned) or FL(OAT).

1. Setup the Serial/RTU Port on the gateway as a ROC Link Master.

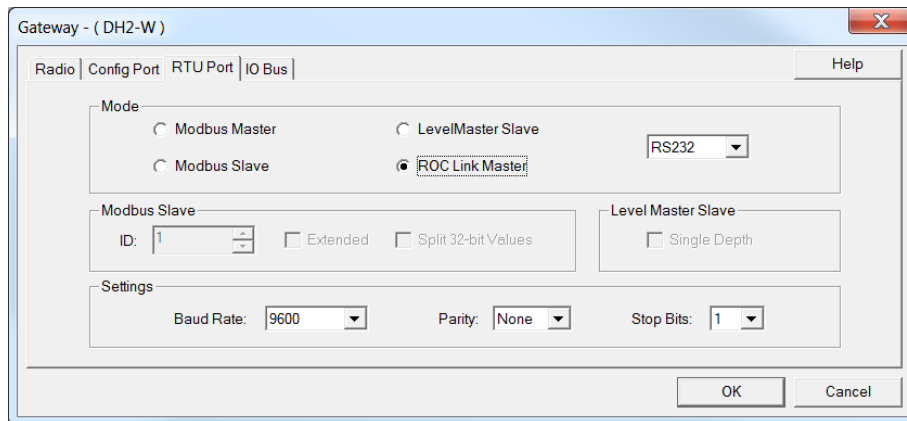

2. Insert a ROC Link Module for the gateway.

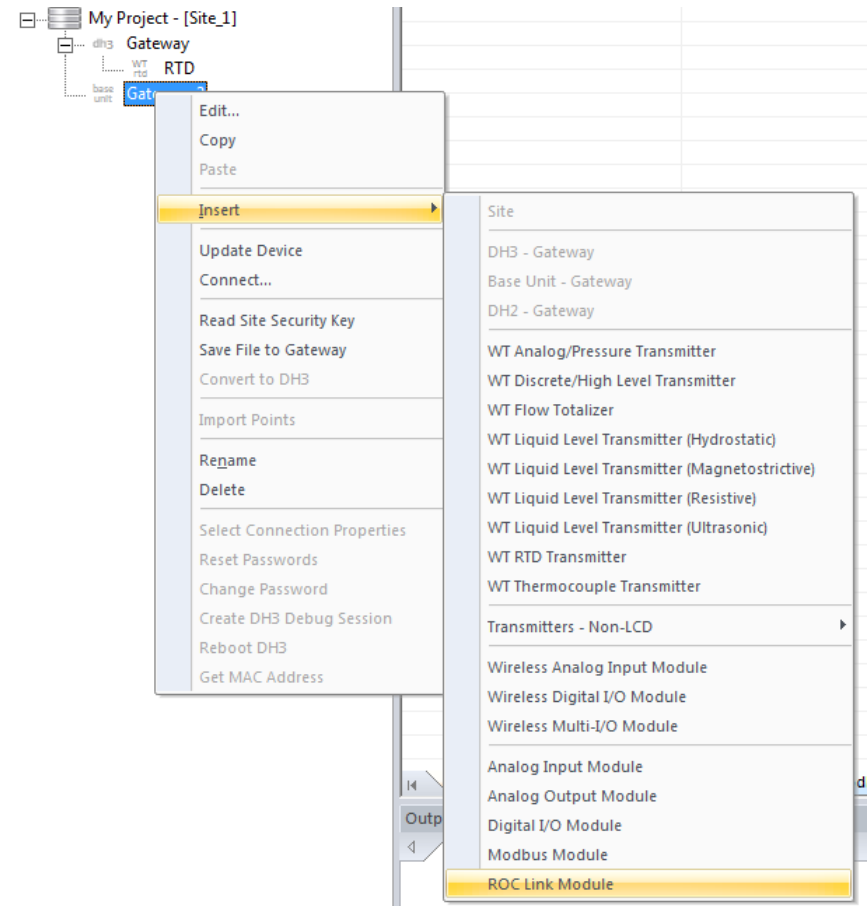

3. Configure the ROC Link Module.

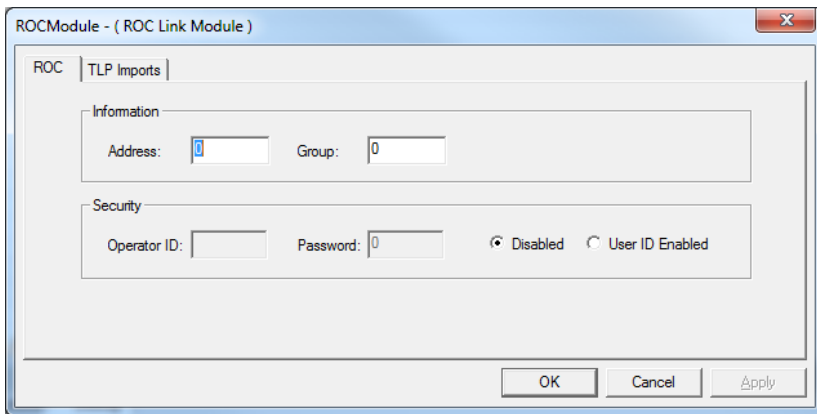

a. Enter the ROC **Information** and **Security** parameters if needed.

4. Set the read **Interval** and click the **Add** button to add points (supports up to 10 points).

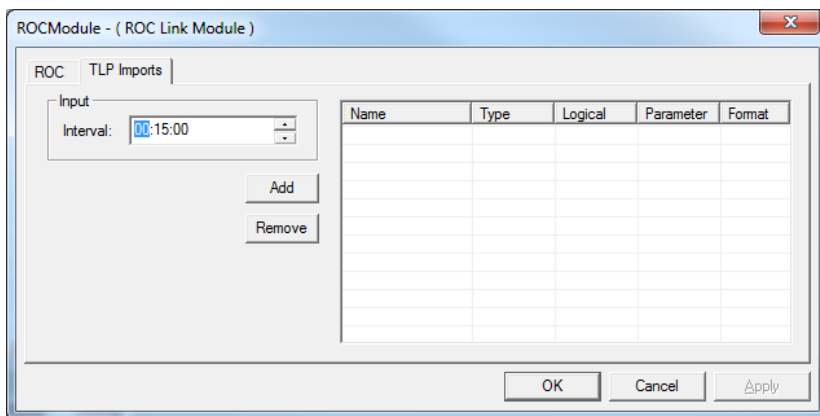

5. Configure the points.

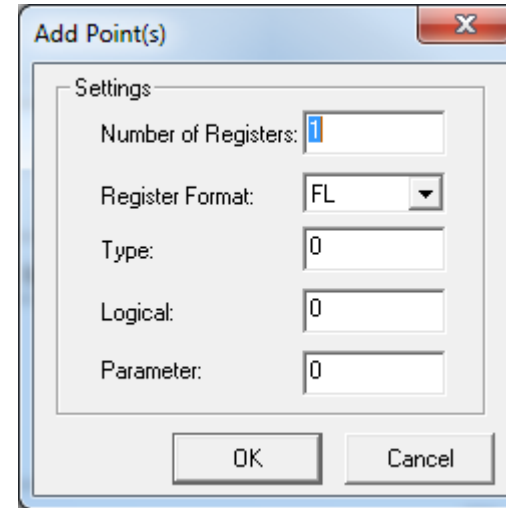

6. Verify addition of the ROC Module in the project tree.

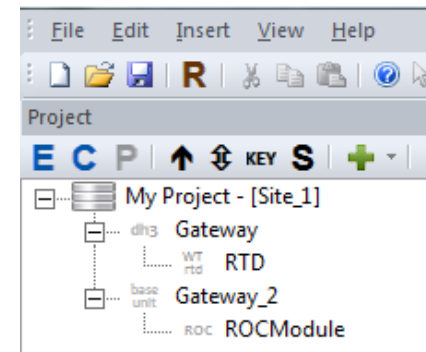

7. Save the project file and update the gateway.

30. SAVING THE PROJECT FILE TO THE GATEWAY

The BreeZ Software allows you to save the project file to any wireless gateway.

By saving the project file to the gateway, field users will have access to the file and the possibility of losing the file is eliminated.

Note: Every time a project file is retrieved, modified, and used for updating devices, be sure to save the revised file back onto the gateway. BreeZ now provides you with the option to re-save the project file automatically when you update the device.

1. **Connect the PC to the gateway.**
2. **Click on the gateway in the project tree.**
 - a. If you have multiple gateways in a project file, be sure to note which gateway will store the project file.
 - b. Using the primary gateway for saving the project file is recommended.
3. **Click the S Save File to Gateway button.**

4. **Select the desired project file from the file directory and click OK.**
5. **The Output Build tab provides visual confirmation.**

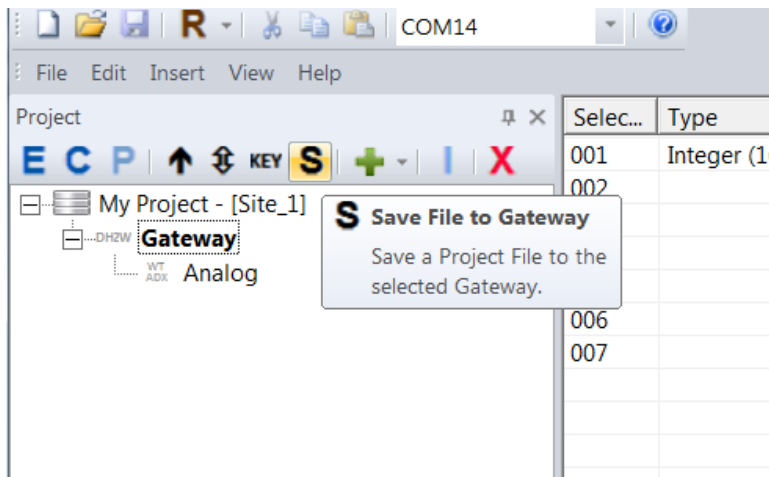
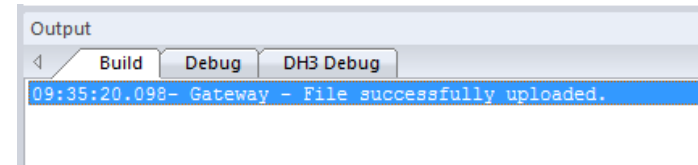

31. RETRIEVING THE PROJECT FILE FROM THE GATEWAY

A stored project file can be retrieved using the following instructions.

Note: Every time a project file is retrieved, modified, and used for updating devices, be sure to save the revised file back onto the gateway. BreeZ now provides you with the option to re-save the project file automatically when you update the device.

1. Connect the PC to the gateway.
2. Run the BreeZ Software.
3. Close the project creation wizard.



4. Click the **R** (Retrieve Project File) button.
 - a. Select the gateway type from dropdown menu.

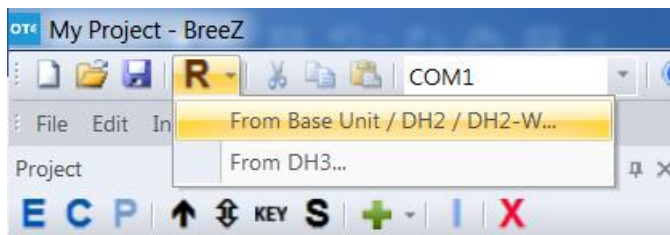

5. Select the location to save the retrieved project file.

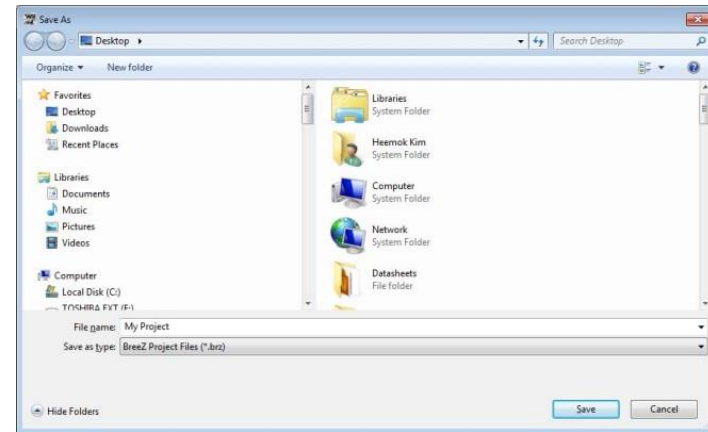

6. The retrieved file will automatically be opened.

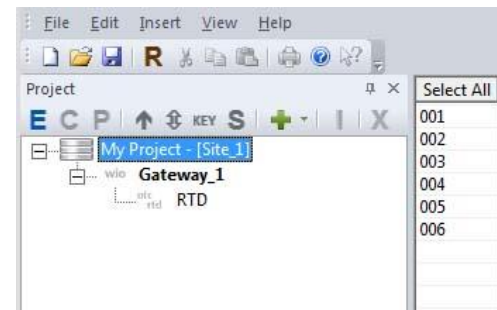

After making any modifications to the project file, be sure to re-save the project file onto the gateway.

32. SITE SECURITY KEY

1. Default: When creating a new project file in BreeZ, **Enhanced Site Security** is automatically enabled.

- a. You can verify the status by viewing the **Site** properties.
 - i. Click the **Site** in the project tree, then click the **E** Edit button.
 - ii. See if the box is checked under **Security**.

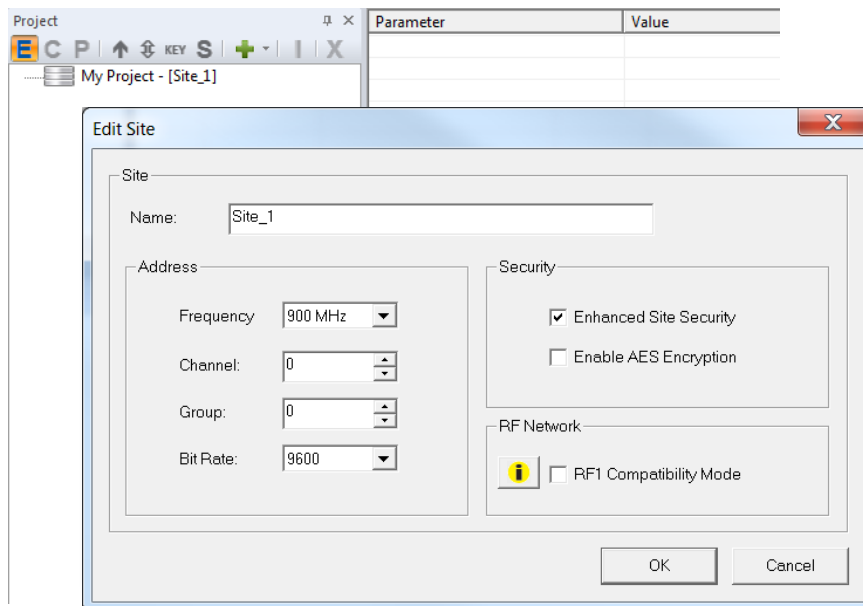

- b. Double-click on the **Site** in the project tree and actual site key can be viewed.

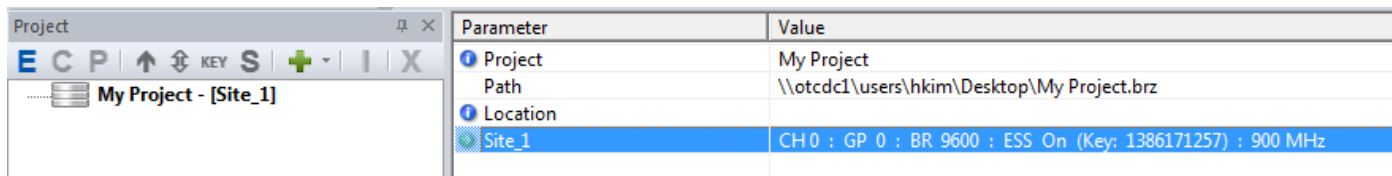

2. File saving behavior in relation to Enhanced Site Security.



- a. The security key will change when:
 - i. Saving a new project file in BreeZ.
 - ii. Changing the file name using Windows® (Modifying the file name outside of BreeZ).
 - iii. Using the **Save As** function in BreeZ, then saving file in a new directory. BreeZ will prompt you when this happens and gives you the option the retain or change the key.

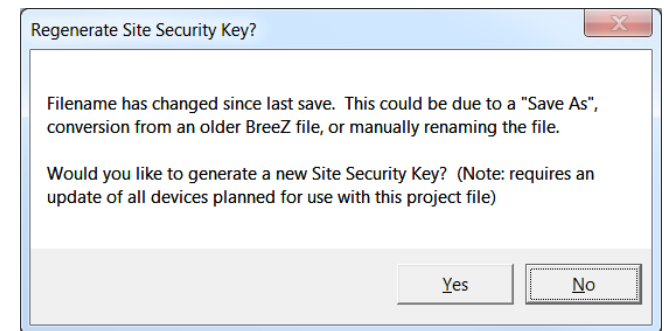

- b. The security key will NOT change when:
 - i. Opening an existing file in BreeZ, modifying it, then saving it.
 - ii. Making no changes to a file, then saving or closing it.
 - iii. Copying and pasting a project file in Windows.

3. What to do when the key is lost.

- a. If a key is lost or switched accidentally to an existing project file, the key can be retrieved from the gateway.
- b. Connect the PC to the gateway.
- c. Double-click on the gateway in the project tree.
- d. Right-click over the gateway, then select **Read Site Security Key**.

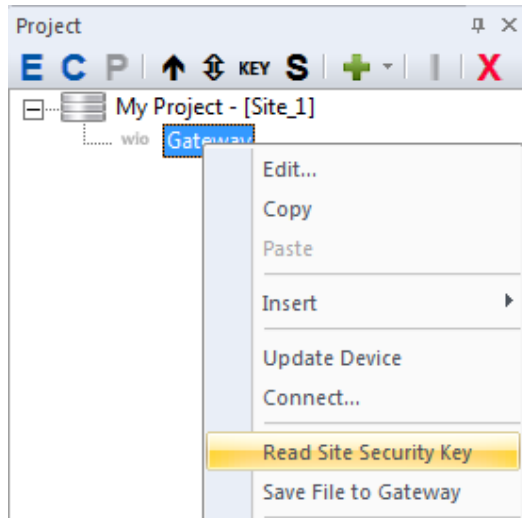

- f. Double-click on **Site** in the project tree and verify the key was updated.

Parameter	Value
Project	My Project 2
Path	\\otcd1\users\hkim\Desktop\asdfasdfas.brz
Location	
Site_1	CH0 : GP 0 : BR 9600 : ESS On (Key: 1386282994) : 900 MHz

- e. Verify the key retrieval using the **Output Build** tab window.

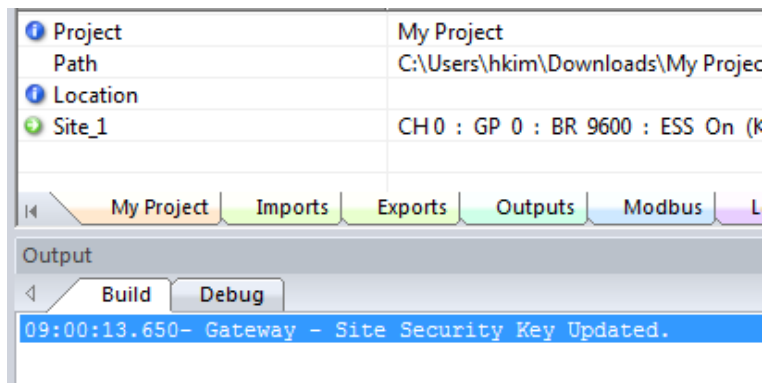

33. TROUBLESHOOTING

1. The gateway is not communicating with the BreeZ Software.

- Connect the PC to the gateway.
- Confirm that PC's COM port and the COM port configured in the BreeZ Software are the same. Also, verify that the COM port is not being used by another device as this can block communications with the gateway.
- Check that the appropriate device is selected in the BreeZ Software.

2. The gateway is not communicating with a transmitter.

- Update all the devices with the same project file.
- Confirm that the antennas of all devices have a clear line of sight and are within the RF range.
- Change the Channel of the site and update all the devices.
- Increase the Tx power of all the devices if available.
- Confirm that the Interval setting for the devices is correct.
- Try increasing retries: default 3.
- Check the firmware of the device.

3. Resetting the gateway.

The front panel of the gateway has a reset button for reinitializing the device. The button is recessed to prevent accidental resets.

To reset the gateway:

- Locate the reset button on the gateway. Using a small screwdriver, push in and hold the recessed reset button, then release. The LED flashes five times after the device is reset.

34. GENERAL MAINTENANCE

The DH2-W Wireless Gateway is easy to maintain and does not require periodic system checks. It generally only needs a yearly visual inspection for the following:

- Is the gateway still securely fastened to the mounting location?
- Are there any visible signs of corrosion, cracks or residue build-up on the device?
- Has anything about the intended use of the original application changed?

If the device is securely fastened, with no signs of corrosion, cracks, residue build-up, or if nothing has changed about the location of its intended use, it should continue to operate within designed specification.

If the device is not securely fastened; if there are signs of corrosion, cracks, residue build-up; or if there has been a change to the location of its intended use resulting in undesirable performance, contact the manufacturer for service instructions.

Cleaning: To prevent static discharge, wipe the outer casing with a damp cloth only.

35. WARRANTY (LIMITED)

- a. OleumTech warrants that goods described herein and manufactured by OleumTech are free from defects in material and workmanship for two (2) years from the date of shipment. Batteries are expressly excluded from this warranty. Battery life and replacement batteries may be warranted under separate agreement depending on specific customer needs and applications.
- b. OleumTech warrants that goods repaired by it pursuant to the warranty are free from defects in material and workmanship for a period to the end of the original warranty or ninety (90) days from the date of delivery of repaired goods, whichever is longer.
- c. Warranties on goods not manufactured by OleumTech are expressly limited to the terms of the warranties given by the manufacturer of such goods.
- d. All warranties are void in the event that the goods or systems or any part thereof are (i) misused, abused or otherwise damaged, (ii) repaired, altered or modified without OleumTech's consent, (iii) not installed, maintained and operated in strict compliance with instructions furnished by OleumTech, (iv) worn, injured or damaged from abnormal or abusive use in service time, (v) subjected to acts of God, or extreme weather phenomenon including, but not limited to, flood, lightning, tornado or hurricane, or (vi) intentional acts including, but not limited to vandalism, sabotage, explosion or acts of terrorism.
- e. THESE WARRANTIES ARE EXPRESSLY IN LIEU OF ALL OTHER WARRANTIES EXPRESSED OR IMPLIED (INCLUDING WITHOUT LIMITATION WARRANTIES AS TO MERCHANTABILITY AND FITNESS FOR A PARTICULAR PURPOSE), AND NO WARRANTIES, EXPRESSED OR IMPLIED, NOR ANY REPRESENTATIONS, PROMISES, OR STATEMENTS HAVE BEEN MADE BY OLEUMTECH UNLESS ENDORSED HEREIN IN WRITING. FURTHER, THERE ARE NO WARRANTIES, WHICH EXTEND BEYOND THE DESCRIPTION OF THE FACE HEREOF. ANY WARRANTIES BEYOND THOSE SET FORTH HEREIN MUST COME DIRECTLY FROM OLEUMTECH.

36. REVISION HISTORY

Version A

New format/document.

Revision B

Revised document template.
Revised ordering of sections.
Updated product overview section.
Updated networking diagram.
Section added technical specifications.
Revised required items for basic setup.
Minor updates to BreeZ project creation section.
Section added for managing RF host addressing table.
Updated com port setup section.
Revised programming gateway/upgrading firmware section.
Revised updating transmitter section.
Revised upgrading firmware section.
Add a mention of BreeZ displaying level data in feet and inches in the polling Modbus register section.
Revised peer-to-peer section.

Revision C

Replaced gateway images without antennas.

Revision D

Added Flexible Modbus Table Management System subsection at the end of Section 17.
Updated various screenshots to match BreeZ v6.1.
IECEX temperature range changed to -40 °C to 70 °C.
Added 868 MHz radio option.

Revision E

Corrected antenna connector drill hole diameter requirement to 5/8" for NEMA enclosures.

Revision F

Updated specs with improved power consumption data.

Revision G

Added wiring diagrams for I/O Modules.
Updated specs with revised 2.4 GHz RF range data.
Revised RF maximum range data.
Revised DH3 programming instructions.

Revision H

Revised 2.4 GHz RF range data.

Revision J

Revised document template and styling.
Revised section ordering for ease of use.
Fixed typographical errors.
Minor instructional revisions made throughout the document for improving clarity.
Removed index and glossary sections.
Revised and combined safety, certifications, and compliance into one section.
Updated technical specifications.
Revised digital level output – active high wiring diagram.
Revised items required for setup section.
Revised wiring diagram section.
Revised RF setup/security section.
Revised installation section.
Revised download and install software section.
Revised creating a project file section.
Revised peer to peer section.
Revised I/O mapping section.
Revised mapping an import point section.
Revised Modus master function section.
Combined COM port setup and updating programming gateway sections.
Removed programming other gateway section.
Removed updating the transmitter section.
Removed configuring the Wireless Multi-I/O Module section.
Removed configuring the RS485 I/O Expansion System section.
Removed templating from a master project file section.

Revision K

Antenna connector changed from MMCX to SMA.

OleumTech®

19762 Pauling Way
Foothill Ranch, CA. 92610
Phone: 866.508.8586 • 949.305.9009
Fax: 949.305.9010
<https://oleumtech.com>

OleumTech has made a good faith effort to ensure the accuracy of the information in this document and disclaims the implied warranties of merchantability and fitness for a particular purpose and makes no express warranties, except as may be stated in its written agreement with and for its customers.

OleumTech shall not be held liable to anyone for any indirect, special or consequential damages due to omissions or errors. The information and specifications in this document are subject to change without notice.

Copyright © 2019. All Rights Reserved.
OleumTech and BreeZ are registered trademarks of OleumTech Corporation. Other trademarks and registered trademarks are the property of their respective owners.