



Where Automation Connects.



ILX56-PNC
PROFINET Controller
ControlLogix®

October 13, 2025

USER MANUAL

Your Feedback Please

We always want you to feel that you made the right decision to use our products. If you have suggestions, comments, compliments or complaints about our products, documentation, or support, please write or call us.

ProSoft Technology, Inc.

+1 (661) 716-5100

+1 (661) 716-5101 (Fax)

www.prosoft-technology.com

ps.support@belden.com

ILX56-PNC User Manual
For Public Use.

October 13, 2025

ProSoft Technology®, is a registered copyright of ProSoft Technology, Inc. All other brand or product names are or may be trademarks of, and are used to identify products and services of, their respective owners.

Content Disclaimer

This documentation is not intended as a substitute for and is not to be used for determining suitability or reliability of these products for specific user applications. It is the duty of any such user or integrator to perform the appropriate and complete risk analysis, evaluation and testing of the products with respect to the relevant specific application or use thereof. Neither ProSoft Technology nor any of its affiliates or subsidiaries shall be responsible or liable for misuse of the information contained herein. Information in this document including illustrations, specifications and dimensions may contain technical inaccuracies or typographical errors. ProSoft Technology makes no warranty or representation as to its accuracy and assumes no liability for and reserves the right to correct such inaccuracies or errors at any time without notice. If you have any suggestions for improvements or amendments or have found errors in this publication, please notify us.

No part of this document may be reproduced in any form or by any means, electronic or mechanical, including photocopying, without express written permission of ProSoft Technology. All pertinent state, regional, and local safety regulations must be observed when installing and using this product. For reasons of safety and to help ensure compliance with documented system data, only the manufacturer should perform repairs to components. When devices are used for applications with technical safety requirements, the relevant instructions must be followed. Failure to use ProSoft Technology software or approved software with our hardware products may result in injury, harm, or improper operating results. Failure to observe this information can result in injury or equipment damage.

© 2025 ProSoft Technology. All Rights Reserved.



For professional users in the European Union

If you wish to discard electrical and electronic equipment (EEE), please contact your dealer or supplier for further information.



Prop 65 Warning – Cancer and Reproductive Harm – www.P65Warnings.ca.gov

Agency Approvals and Certifications

Please visit our website: www.prosoft-technology.com

Table of Contents

1	Preface	5
1.1	Introduction to the ILX56-PNC	5
1.2	Features	6
1.3	Architecture	6
1.4	Additional Information.....	9
1.5	Support	9
1.6	Quickstart Guide.....	9
2	Installation	10
2.1	Module Layout.....	10
3	Setup	12
3.1	Install Configuration Software	12
3.2	GSDML File Management.....	13
3.3	Creating a New Project	15
3.4	ILX56-PNC Configuration	17
3.4.1	General.....	17
3.4.2	PROFINET	19
3.5	Module Download.....	21
3.6	Device DCP Discovery (Online)	23
3.6.1	DCP Discovery	23
3.6.2	DCP Discovery Functions	25
3.7	Adding PROFINET Devices	27
3.7.1	General.....	29
3.7.2	Device PROFINET Configuration.....	30
3.7.3	Interface.....	32
3.7.4	Slot Configuration	34
3.7.5	Mapping.....	39
3.7.6	Advanced	41
3.8	Studio 5000 Configuration	42
3.8.1	Standard Add-On Profile	42
3.8.2	Generic Profile.....	46
3.9	Logix Mapping	48
4	SD Card	53
4.1	Firmware.....	53
4.2	Configuration	54
4.2.1	Exporting the Configuration File	54
5	Operation	56
5.1	Logix Operation	56
5.1.1	PNC Controller Status	56
5.1.2	PNC Control	59
5.1.3	Device Status and Input Data Exchange	60
5.1.4	Device Control and Output Data Exchange	62
5.1.5	IO Data Status (IOPS / IOCS).....	63
5.1.6	Device Alarm Unloading.....	65

5.1.7	Explicit Acyclic Messaging	67
5.2	Acyclic Messaging Utility	69
6	Firmware Upgrade	70
<hr/>		
7	Media Redundancy Protocol (MRP)	72
<hr/>		
7.1	Basic Rules	73
8	S2 Redundancy	74
<hr/>		
8.1	Configuration	75
8.1.1	Controller Configuration - General	75
8.1.2	Device Configuration	76
8.1.3	Module Download.....	76
8.1.4	Logix Configuration	77
9	Diagnostics	78
<hr/>		
9.1	LEDs.....	78
9.1	Module Status Monitoring.....	80
9.1.1	ILX56-PNC	80
9.1.2	Device Status	88
9.2	Module Event Log	94
10	Technical Specifications	95
<hr/>		
10.1	Electrical.....	95
10.2	PROFINET	95
10.3	ControlLogix	95
10.4	Certifications.....	95
11	Appendix	96
<hr/>		
11.1	PROFINET Response Error Codes	96
12	ILX56-PNC ET200M QuickStart	98
<hr/>		
12.1	GSDML File Management Tool.....	98
12.1.1	Installation	98
12.1.2	Configuration	99
12.2	Creating a New Project	101
12.2.1	PNC Configuration	102
12.3	Adding a PROFINET Device	103
12.4	Downloading the Configuration to the ILX56-PNC.....	105
12.5	ControlLogix Configuration.....	107
12.6	Cyclic Data	109
13	Support, Service, and Warranty	110
<hr/>		
13.1	Contacting Technical Support	110
13.2	Warranty Information.....	110

1 Preface

1.1 Introduction to the ILX56-PNC

This manual describes the installation, operation, and diagnostics of the ProSoft ILX56-PNC PROFINET Controller module. The ILX56-PNC module will operate as a PROFINET controller configuring, parameterizing, and exchanging data with PROFINET devices.

The ILX56-PNC slots into a 1756 ControlLogix backplane and operates as a PROFINET Controller, allowing the data from connected PROFINET devices to be exchanged with the ControlLogix controller.

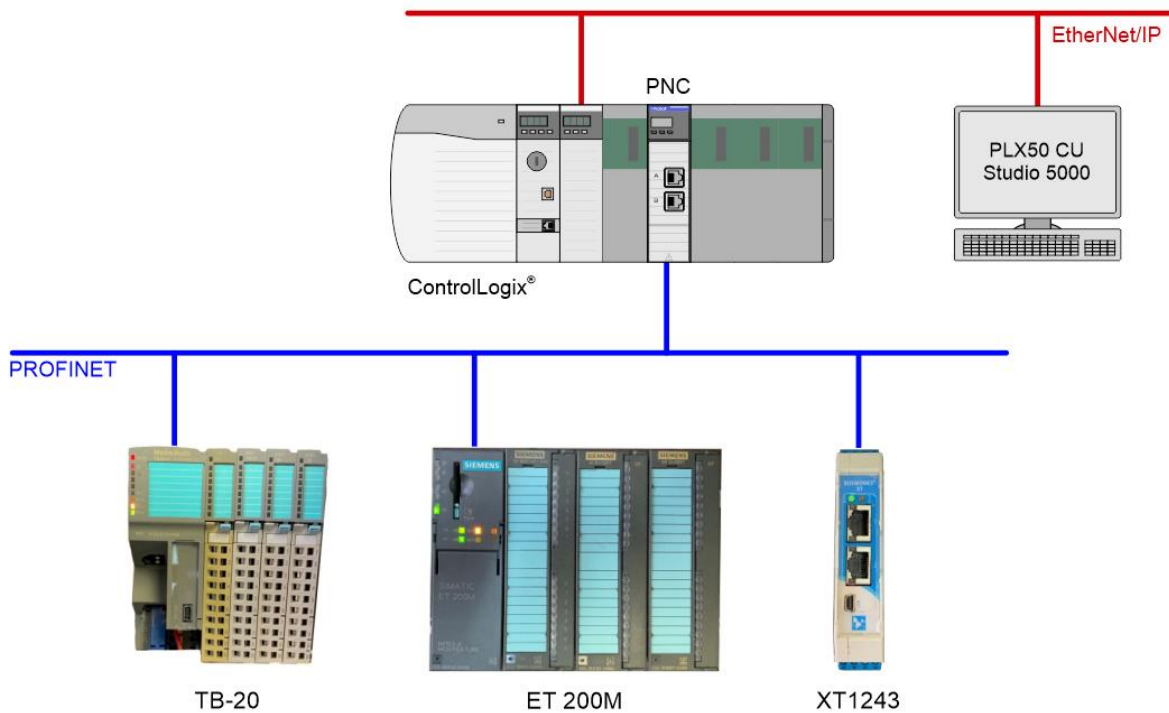

Figure 1.1 – Typical ILX56-PNC PROFINET architecture

The module is configured using the PLX50 Configuration Utility software from ProSoft. The PLX50 Configuration Utility is also used to configure and parameterize the PROFINET devices using the device GSDXML files.

1.2 Features

- The ILX56-PNC module operates as a PROFINET controller.
- Exchange up to 4096 bytes of input (and status) data and 4096 bytes of output (and control) data between the ControlLogix controller and the PROFINET devices.
- Cyclic communication with up to 64 x PROFINET device using PROFINET Real Time (RT) data exchange.
- Data formatted into engineering units for ControlLogix platform by using the automatically generated mapping imports for Logix User Defined Data Types (UDTs).
- The module supports Media Redundancy Protocol (MRP) and can operate as a MRP Manager or MRP Client.
- SD Card can be used for firmware and configuration backup.
- The module supports PROFINET devices using System Redundancy S2.
- Complies with PROFINET conformance class B.
- PROFINET device discovery, and name and address assignment (using DCP) supported.
- Statistics and diagnostics supported for the PROFINET controller and for each PROFINET device.
- Supports Alarm management from PROFINET devices and unloading into Logix.

1.3 Architecture

The figures below provide some typical examples of network configurations.

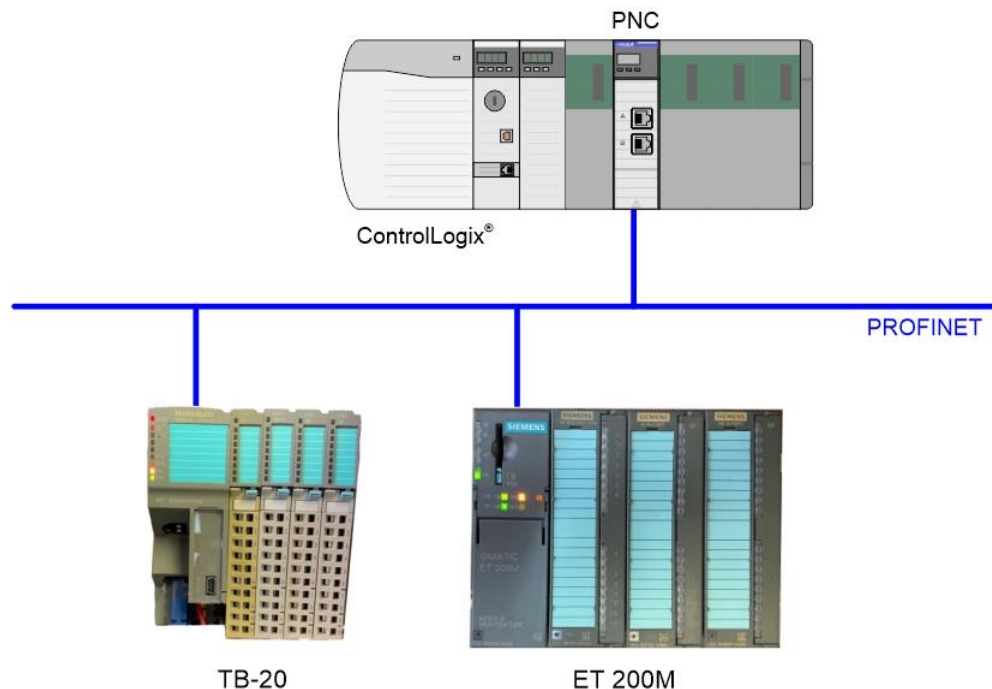

Figure 1.2 – Basic Configuration

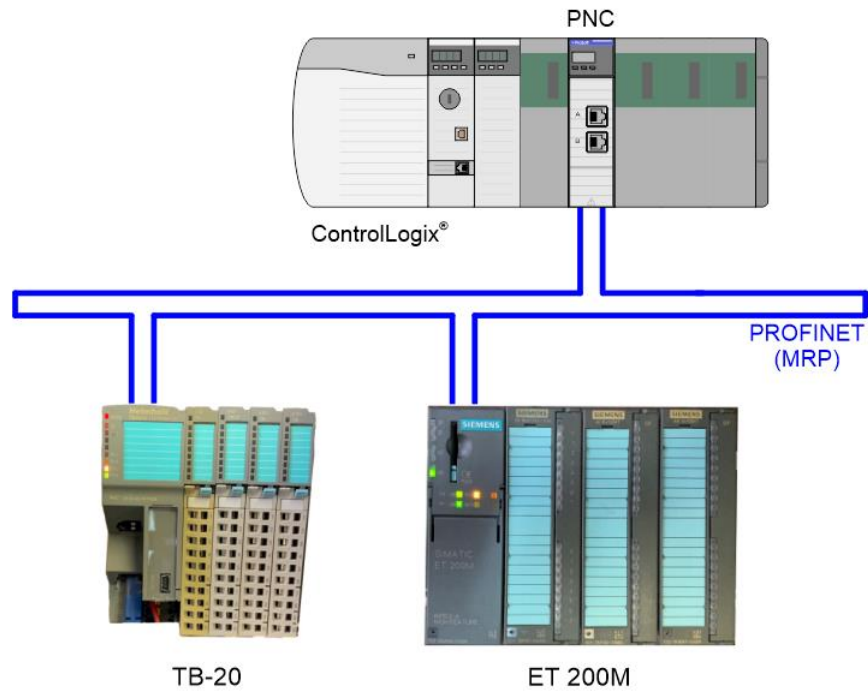

Figure 1.3 – Basic Configuration with PROFINET MRP

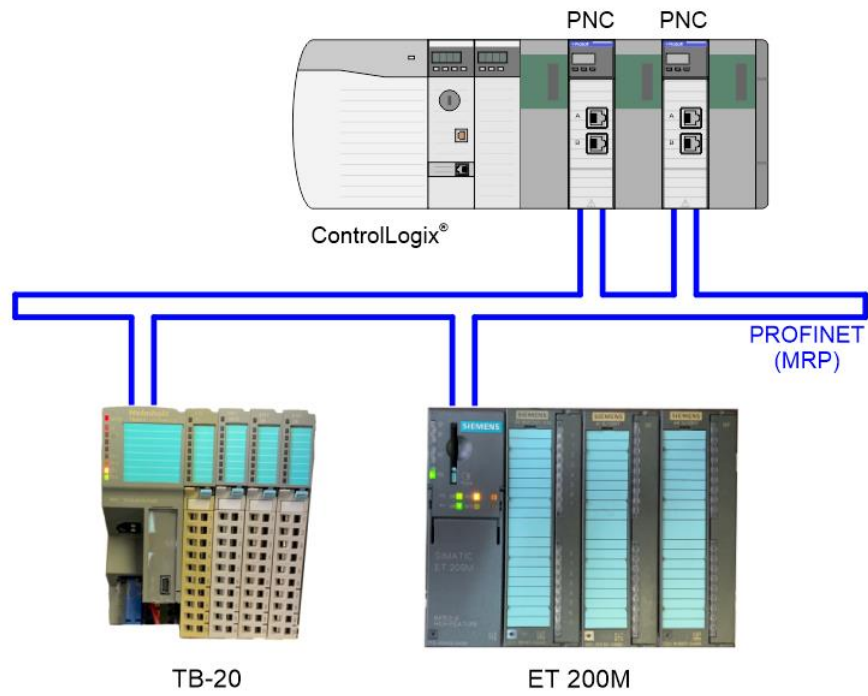

Figure 1.4 – Redundant PNC Configuration with PROFINET MRP

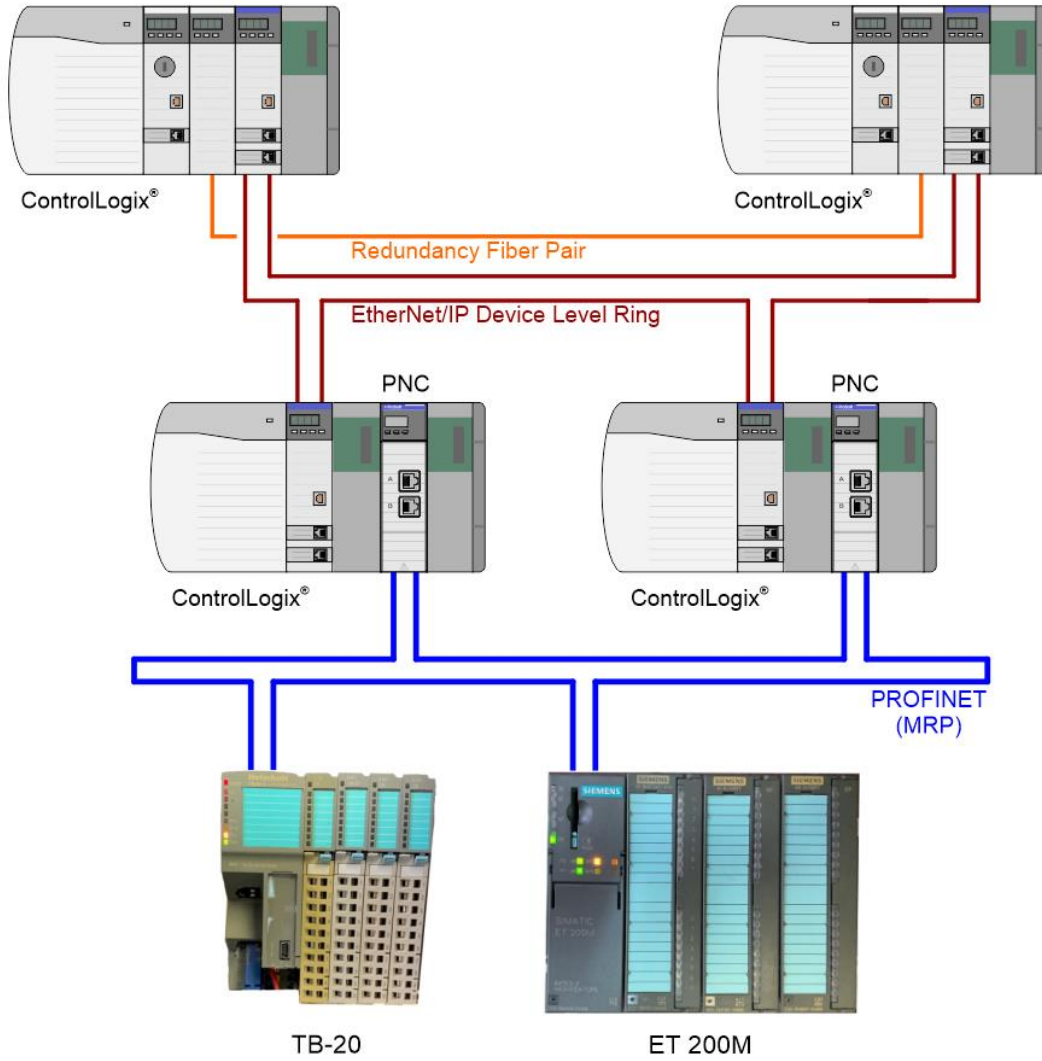

Figure 1.5 – Redundant ControlLogix and Redundant PNC Configuration with PROFINET MRP

1.4 Additional Information

The following documents contain additional information that can assist the user with the module installation and operation.

Resource	Link
PLX50 Configuration Utility Installation	www.prosoft-technology.com
ILX56-PNC User Manual	www.prosoft-technology.com
ILX56-PNC Datasheet	

Table 1.1 - Additional Information

1.5 Support

Technical support is provided via the Web (in the form of user manuals, FAQ, datasheets etc.) to assist with installation, operation, and diagnostics.

For additional support the user can use either of the following:.

Resource	Link
Contact us	www.prosoft-technology.com
Support email	support@prosoft-technology.com

Table 1.2 - Support Details

1.6 Quickstart Guide

For a Quickstart Guide to configure the ILX56-PNC as a PROFINET Master to communicate with a SIEMENS SIMATIC ET200M PROFINET device, please see chapter *12 ILX56-PNC ET200M QuickStart*.

2 Installation

2.1 Module Layout

The ILX56-PNC module has two PROFINET (Ethernet) ports on the front of the module. These ports support Full- and Half-duplex, at speeds of 10Mbit/s, 100Mbit/s, or 1Gbit/s.

Note: All required power for the module is derived from the ControlLogix backplane.

The module provides 3 diagnostic LEDs and a 4-character alpha-numeric LED display. The LED display provides the mode and status of the module.



Figure 2.1 – ILX56-PNC front view

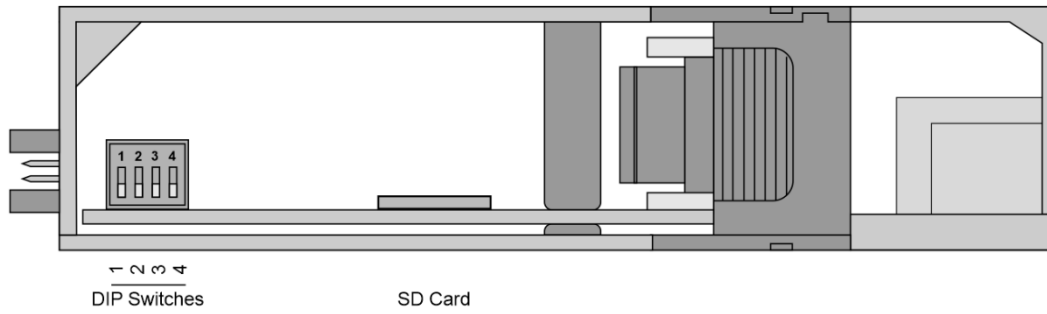

Figure 2.2 – ILX56-PNC bottom view

Located at the bottom of the module are four DIP Switches and an SD memory card slot. These switches can only be accessed when the module is removed from the ControlLogix chassis.

DIP Switch	Description
DIP Switch 1	Used to force the module into “Safe Mode”. When in “Safe Mode”, the module will not load the application firmware and will wait for new firmware to be downloaded. This should only be used in the rare occasion when a firmware update was interrupted at a critical stage.
DIP Switch 2	Used to prevent changes to the configuration.
DIP Switch 3	Reserved
DIP Switch 4	Reserved

Table 2.1 - DIP Switch Settings

3 Setup

This section of the document will walk you through the set-up process needed to use the ILX56-PNC module properly.

3.1 Install Configuration Software

The network setup and configuration of the module is done in the ProSoft PLX50 Configuration Utility. This software can be downloaded from www.prosoft-technology.com.

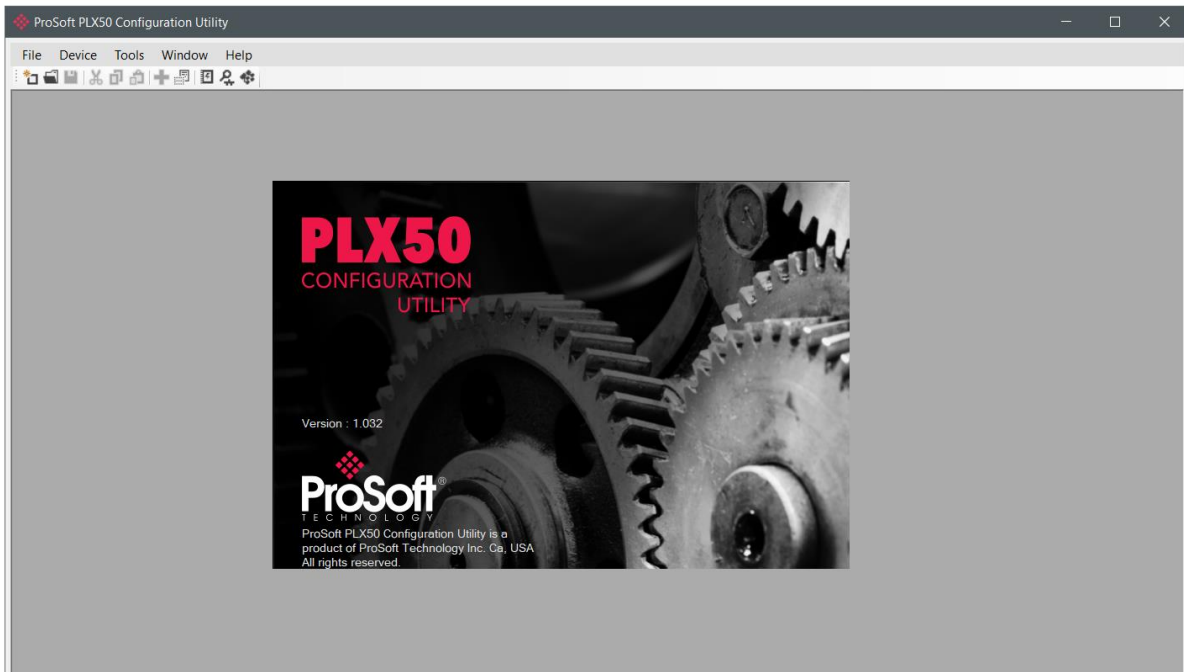

Figure 3.1 - ProSoft PLX50 Configuration Utility Environment

3.2 GSDML File Management

Each PROFINET device has an associated GSDML file that contains the necessary device parameters required to correctly configure the device for data exchange. The PLX50 Configuration Utility manages the GSDML library, which is used for adding devices to the ILX56-PNC.

- 1 The GSDML File Manager is opened by selecting **GSDML FILE MANAGEMENT** under the *Tools* menu in the configuration utility.

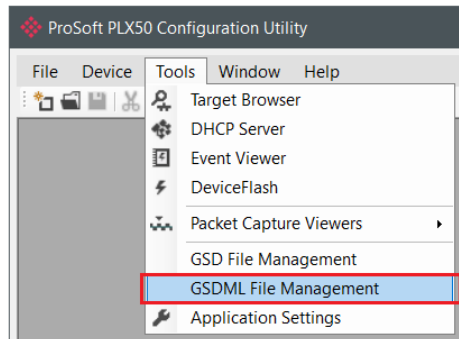

Figure 3.2 – Launching the GSDML File Management Tool

- 2 Once the tool has been opened, a list of registered PROFINET devices is displayed.

The screenshot shows the 'GSDML File Manager' window with a table of registered devices. The table has columns for Vendor, Description, Device ID, Ident., PNI0 Ver., Order Number, Hardware, Software, and GSDML File. A filter section at the top allows filtering by Vendor, Description, Ident., Order Number, and Filename.

Vendor	Description	Device ID	Ident.	PNI0 Ver.	Order Number	Hardware	Software	GSDML File
Acromag	XT1243 Process Voltage I...	0x0037	0x10100001	V2.2	XT1243-xxx	0.0	v1.2	GSDML-V2.3-Acromag-X...
Helmholz GmbH & Co. KG	TB20 PROFINET	0x0007	0x0001	V2.2	600-180-1AA11	1		GSDML-V2.31-Helmholz-...
ProSoft Technology, Inc.	ILX56-PND	0x8251	0x0001	V2.2	ILX56-PND	1	1.01.001	GSDML-V2.31-ProSoft-IL...
ProSoft Technology, Inc.	PLX31-EIP-PND	0x8201	0x80000000	V2.2	EPD1	1	1.00.029	GSDML-V2.3-ProSoft-PL...
ProSoft Technology, Inc.	PLX32-EIP-PND	0x8202	0x80000000	V2.2	EPD2	1	1.02.002	GSDML-V2.3-ProSoft-PL...
SIEMENS	IM151-3 PN	0x0301	0x0300		6ES7 151-3AA00-0AB0	A1.0	R01.11.00	gsdml-v1.0-siemens-et20...
SIEMENS	IM151-3 PN	0x0301	0x0301		6ES7 151-3AA10-0AB0	A1.0	R20.04.01	gsdml-v1.0-siemens-et20...
SIEMENS	IM153-4 PN HF V3.0 Shar...	0x0302	0x0432	V2.2	6ES7 153-4BA00-0XB0	A1.0	V03.00.00	GSDML-V2.3-Siemens-ET...
SIEMENS	IM153-4 PN HF V3.0	0x0302	0x0422	V2.2	6ES7 153-4BA00-0XB0	A1.0	V03.00.00	GSDML-V2.3-Siemens-ET...
SIEMENS	IM153-4 PN HF V4.0 Shar...	0x0302	0x0433	V2.3	6ES7 153-4BA00-0XB0	A1.0	V04.00.00	GSDML-V2.3-Siemens-ET...

Figure 3.3 – GSDML File Management Tool

- To add a new GSDML file, select the **ADD** option under the *GSDML File* menu.

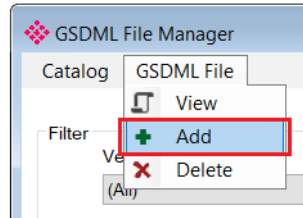

Figure 3.4 – GSDML File Adding

- Select the GSDML file and click **OPEN**.

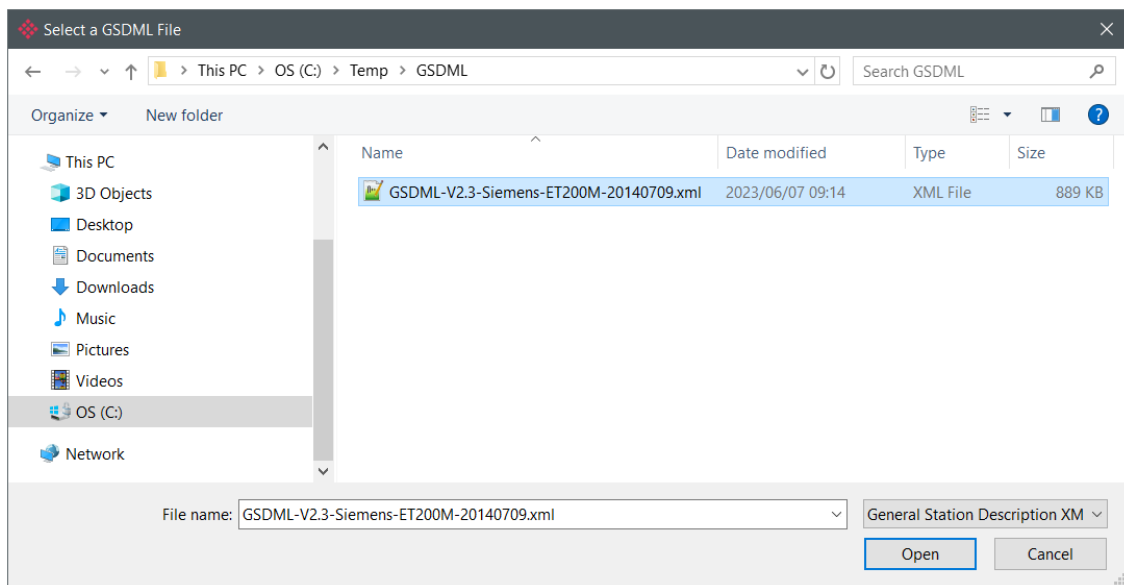

Figure 3.5 – GSDML File Adding

- The GSDML File Management tool will add the PROFINET device to the device list and recompile the GSDML catalog.
- A GSDML catalog can be exported from one PLX50 Configuration Utility and imported into another PLX50 Configuration Utility on a different workstation. This is achieved by selecting **EXPORT** under the *Catalog* menu on one machine and then selecting the **IMPORT** option on the other machine.

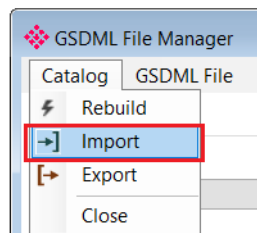

Figure 3.6 – GSDML Catalog importing

3.3 Creating a New Project

Before the user can configure the module, a new PLX50 Configuration Utility project must be created.

- 1 Under the *File* menu, select **NEW**. A PLX50 Configuration Utility Design Tool project will be created, showing the Project Explorer tree view.

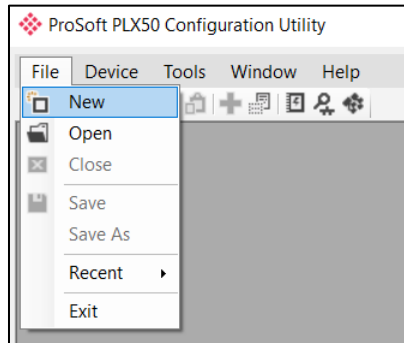

Figure 3.7 - Creating a new project

- 2 A new device can now be added by selecting **ADD** under the *Device* menu.

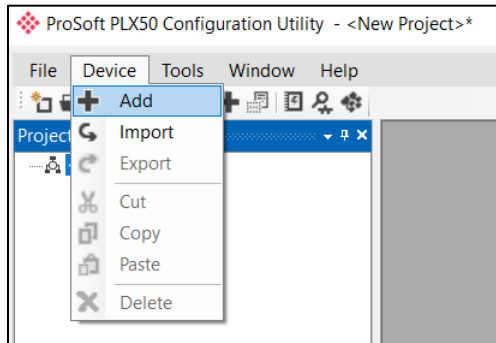

Figure 3.8 - Adding a new device

- 3 In the *Add New Device* window select the **ILX56-PNC** and click the **OK** button.

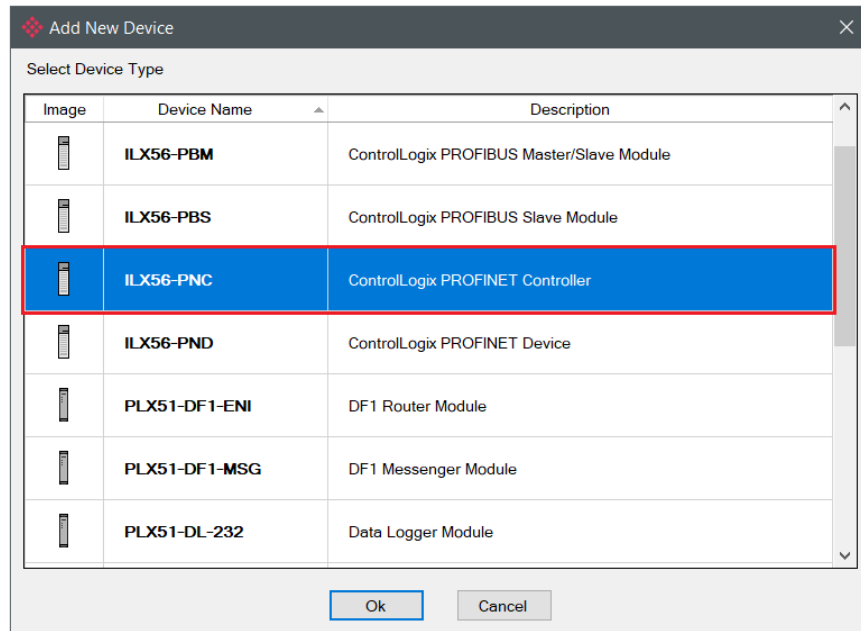

Figure 3.9 – Select ILX56-PNC

- 4 The Configuration window for the new device will be opened. The device configuration window can be reopened by either double-clicking the module in the Project Explorer tree or right-clicking on the module and selecting **CONFIGURATION**.

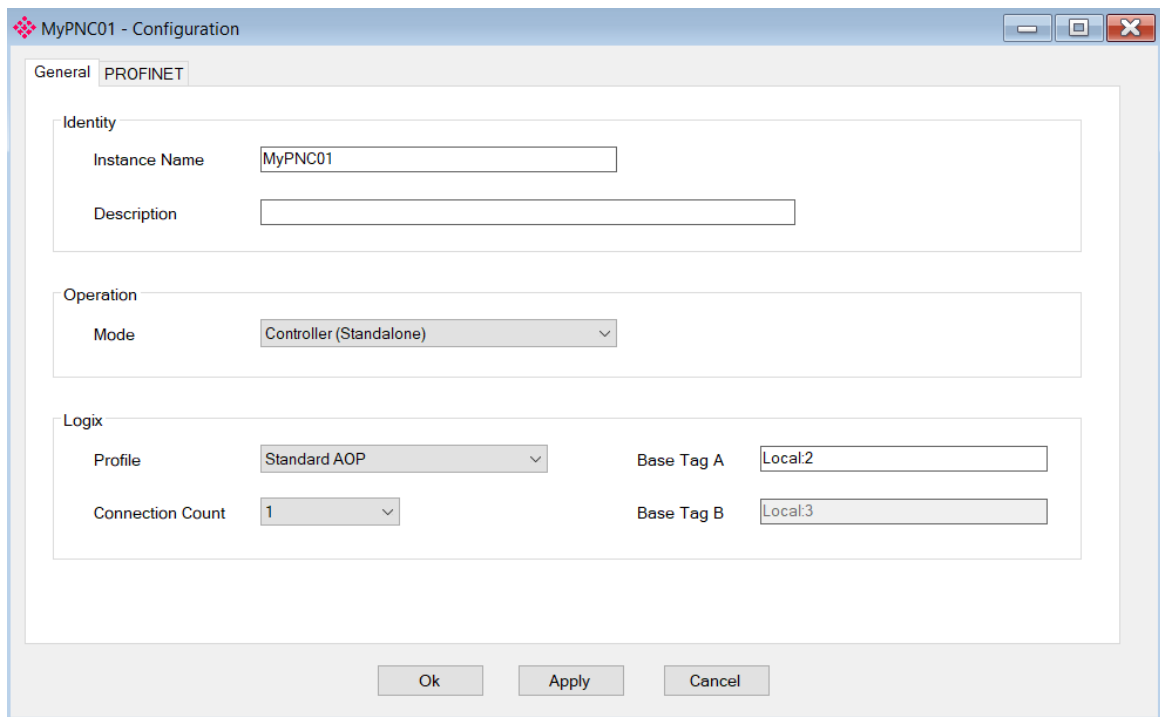

Figure 3.10 – ILX56-PNC configuration

3.4 ILX56-PNC Configuration

All ILX56-PNC configuration takes place within the PLX50 Configuration Utility environment.

Note: Refer to the additional information section for documentation and installation links for the ProSoft PLX50 Configuration Utility.

3.4.1 General

The *General* tab of the ILX56-PNC Configuration window is opened by either double-clicking on the module in the tree, or right-clicking the module and selecting **CONFIGURATION**.

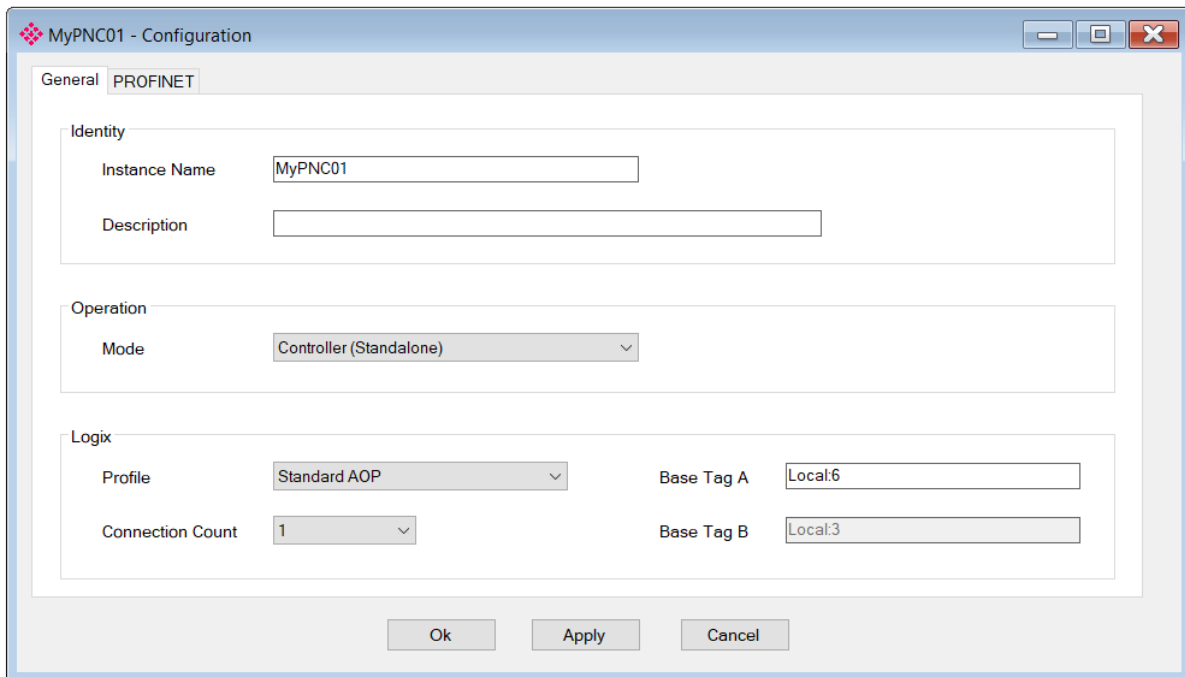

Figure 3.11 – ILX56-PNC General configuration

The General configuration consists of the following parameters:

Parameter	Description
<i>Identity</i>	
Instance Name	User defined name to identify the ILX56-PNC module. Note: This name must match the instance name assigned to the module in the Studio 5000 IO tree.
Description	Used to provide a more detailed description of the application for the module.
<i>Operation</i>	
Mode	The ILX56-PNC can operate in one of two modes: Controller (Standalone) The ILX56-PNC operates as a standalone Controller on the PROFINET network. Controller S2 Redundancy A pair of ILX56-PNC modules operate as redundant PROFINET Controllers for PROFINET devices that support S2 redundancy. Note: Only devices that support PROFINET S2 Redundancy can be used for redundant IO.
<i>Logix</i>	
Profile	The Studio 5000 profile used to instantiate the ILX56-PNC module. Standard AOP This is the preferred profile which allows the user to configure between 1 and 11 connections. Generic Profile This option provides only a single connection and is required for older versions of Logix.
Connection Count	The number of class 1 CIP connection established between the ControlLogix CPU and the module. (1 to 11). Note: This value must match that configured in the Logix IO tree.
Base Tag A Base Tag B	This is the tagname of the ILX56-PNC used for the input and output assembly. For example, if the module is in the local slot connected to a Logix controller the base tag will be Local:x (where x is the slot number). The base tagname is used when generating the Logix L5X file which will automatically map the required data. In a Standalone configuration only Base Tag A is relevant. In an S2 Redundant configuration, both Base Tag A and B will be required.

Table 3.1 - General configuration parameters

3.4.2 PROFINET

The *PROFINET* tab in the Configuration window is opened by either double-clicking on the module icon in the tree, or by right-clicking on the module icon and selecting **CONFIGURATION**.

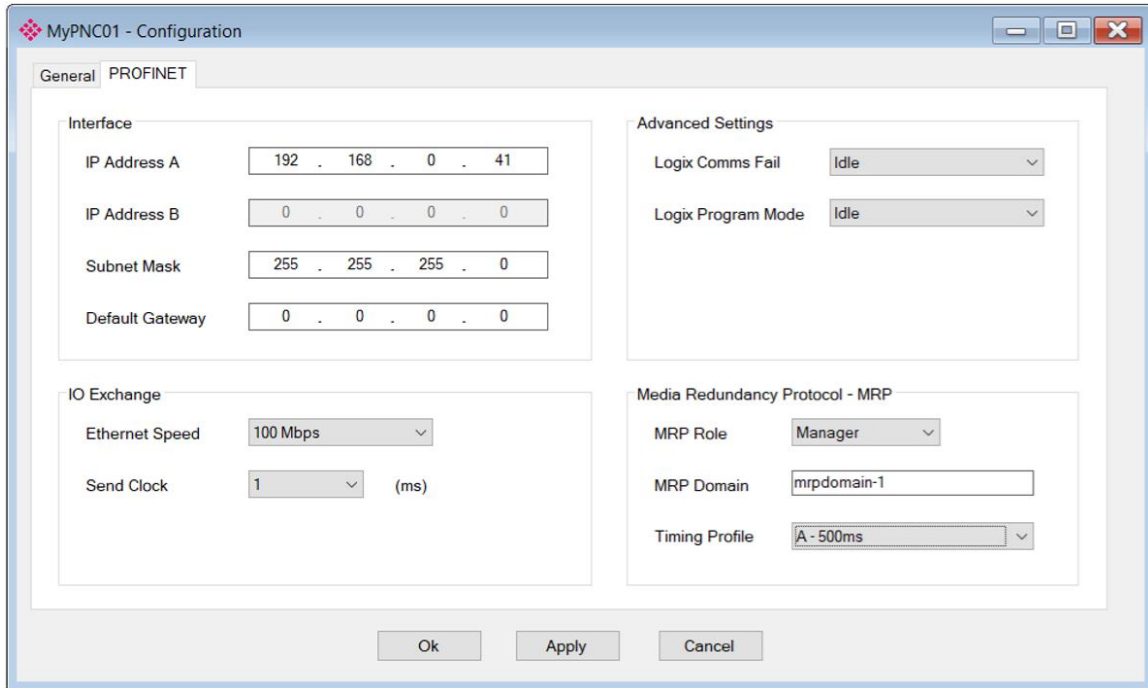

Figure 3.12 – ILX56-PNC PROFINET configuration

The PROFINET configuration consists of the following parameters:

Parameter	Description
<i>Interface</i>	
IP Address A	The IP Address of the module on the PROFINET network. In the case of S2 Redundancy, this is the IP Address of the A module.
IP Address B	When using S2 Redundancy, this is the IP Address of the B module on the PROFINET network. This is disabled when Standalone Controller mode is used.
Subnet Mask	The subnet mask to be used by the module/s on the PROFINET network.
Default Gateway	The IP Address of the Default Gateway to be used by the module/s on the PROFINET network. The gateway allows the module to communicate with PROFINET devices that are not on the same subnet.
<i>I/O Exchange</i>	
Ethernet Speed	The anticipated Ethernet speed of the PROFINET network. This parameter is used for network utilization calculation purposes.
Send Clock	The time period (milliseconds) between two consecutive RT intervals. This period represents the minimum update time for all devices. Each PROFINET device's update time will be a (power of 2) multiple of the Send Clock period.
<i>Advanced Settings</i>	
Logix Comms Fail	Specifies the PROFINET Controller behavior when communication with Logix is lost. Currently, only the IDLE value is supported.

Logix Program Mode	Specifies the PROFINET Controller behavior when the Logix controller is placed in PROGRAM mode. Currently, only the IDLE value is supported.
<i>Media Redundancy Protocol (MRP)</i>	
MRP Role	Sets the module's role in the MRP network management, either: <p>Disabled Media redundancy is not enabled.</p> <p>Client Media redundancy is enabled, the module participates in the ring, but does not manage it.</p> <p>Manager Media redundancy is enabled, the module participates in the ring, and supervises it.</p>
MRP Domain	The identifier for the logical MRP collection. The controller (ILX56-PNC) and the devices in the MRP ring all must have the same MRP Domain configured.
Timing Profile	MRP timing profile to indicate how fast the MRP ring will recover from a fault. <p>Note: The faster the recovery time the more traffic there will be on the Ethernet network.</p>

Table 3.2 - PROFINET configuration parameters

Note: When changing which device is the MRP Manager, there may be a time when there is no configured MRP Manager. An unconfigured MRP Manager can cause an uncontrolled Ethernet ring that will create a network disturbance. The ring must first be broken by disconnecting one of the Ethernet ports, and only reconnected once the configuration process is complete.

3.5 Module Download

Once the ILX56-PNC configuration has been completed, it must be downloaded to the module. The *Connection Path* of the module must be configured before downloading.

- 1 Right-click on the module and select the **CONNECTION PATH** option.

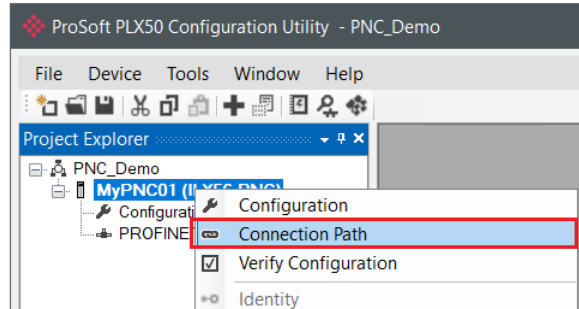

Figure 3.13 – Select Connection Path

- 2 The current *Connection Path A* will be displayed. In the case of S2 Redundancy mode, the *Connection Path B* will also need to be configured. The new connection path can be entered manually or selected by using the *Target Browser*. To use the latter, select the **BROWSE** button.

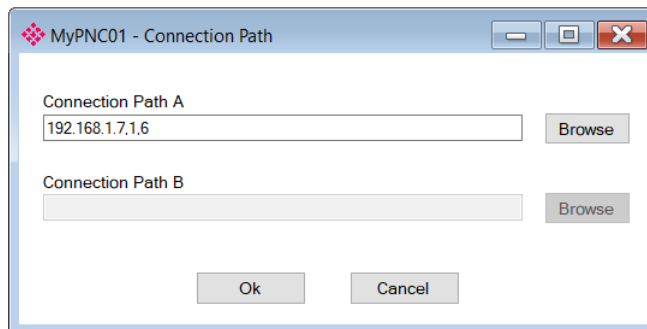

Figure 3.14 – Enter Connection Path

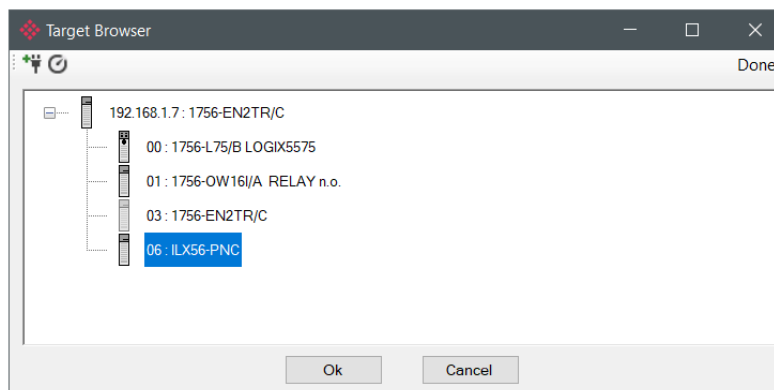

Figure 3.15 – Target Browser

- 3 The configured path will be used to connect to the module.
- 4 To initiate the download, right-click on the module and select the **DOWNLOAD** option.

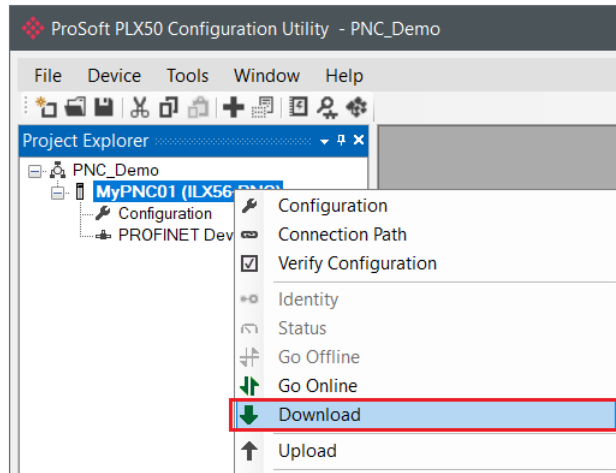

Figure 3.16 - Selecting Download

- 5 Once complete, the user will be notified that the download was successful.

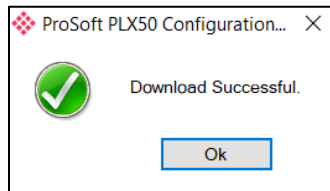

Figure 3.17 - Successful download

- 6 Within the PLX50 Configuration Utility the module will be in the *Online* state, indicated by a green circle around the module's icon. The module is now configured and operational.

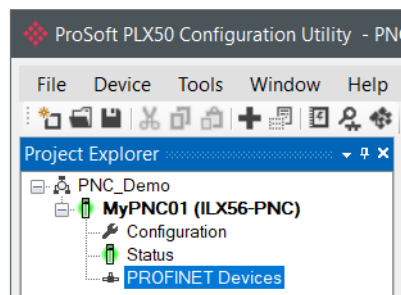

Figure 3.18 - Module online

3.6 Device DCP Discovery (Online)

Once online with the ILX56-PNC in the PLX50 Configuration Utility, the user will be able to scan the PROFINET network for devices.

PROFINET devices can be added in one of two ways:

- Using the online *DCP Discovery* method (described here), or
- Using the manual approach (described in the following section).

3.6.1 DCP Discovery

The device discovery can be found by selecting the *DCP Discovery* tab in the ILX56-PNC *Status* window.

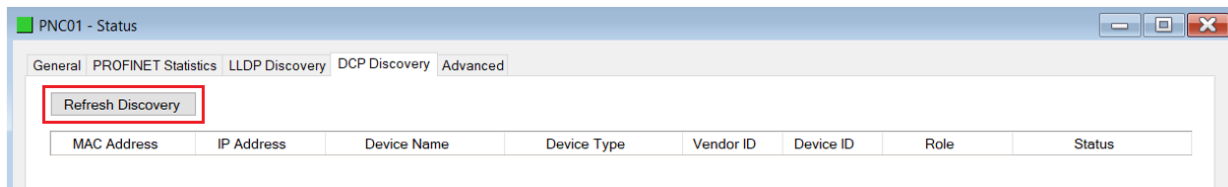

Figure 3.19 – Device Discovery

To refresh the device discovery list, click on the **REFRESH DISCOVERY** button. All discovered devices will be displayed in the list.

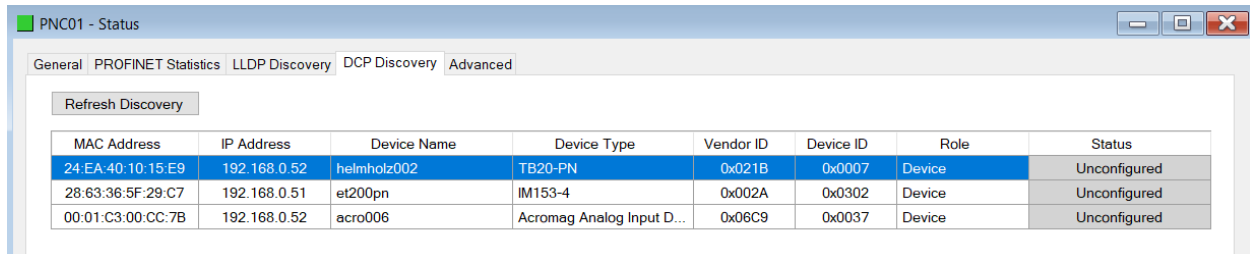

Figure 3.20 – DCP Discovery Result

If a device has been found and is not currently in the ILX56-PNC configured device list the device can be added in this window by right-clicking on the device and selecting the **ADD DEVICE** option.

Note: The associated GSDML file must first be registered before a device can be added to the ILX56-PNC configuration.

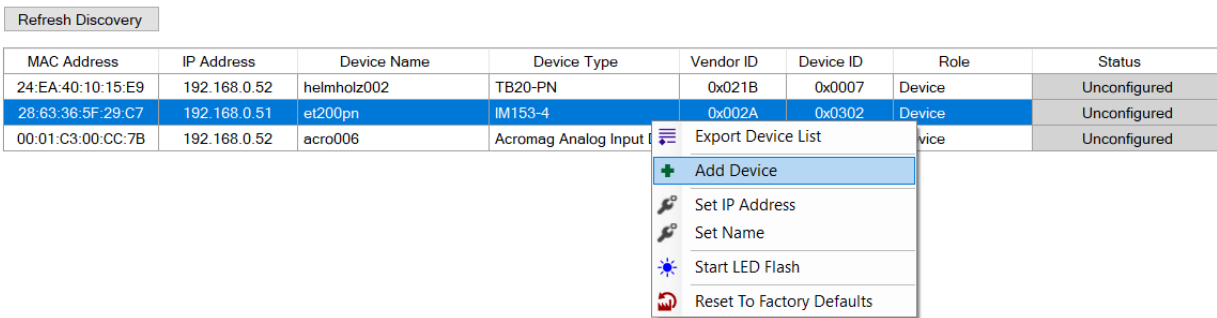

Figure 3.21 – Adding a discovered device

If the selected device has more than one matching GSDML file registered, the user will be prompted to select the GSDML file to be used.

Devices with configurable slots that support the identification of modules will be automatically added. When an identified module in a particular slot has a non-unique *Ident.*, then the user will be prompted to select from a list of matching modules.

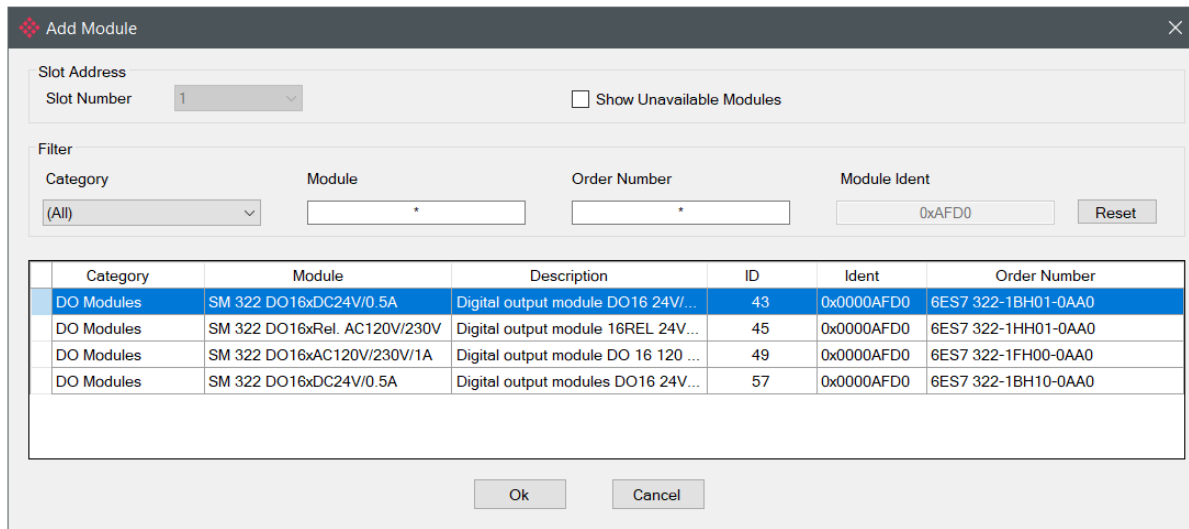

Figure 3.22 – Adding a discovered module

The resulting device configuration window will then be opened. See the subsequent section on Adding PROFINET Devices for more details.

3.6.2 DCP Discovery Functions

In addition to adding a device online, a number of other DCP functions are available via the *DCP Discovery* tab:

- Export Device List
- Set IP Address
- Set Name
- Start LED Flash
- Reset To Factory Defaults

3.6.2.1 Export Device List

This function exports all the details of the DCP Discovery to a CSV (comma-separated variable format) file.

3.6.2.2 Set IP Address

This function allows the user to change the IP parameters of a connected device. When selected, the *Set Device IP Parameters* window opens.

The screenshot shows a dialog box titled "Set Device IP Parameters" with a close button (X) in the top right corner. The dialog contains the following fields and values:

Name	helmholz002
MAC Address	24:EA:40:10:15:E9
Device Type	TB20-PN
IP Address	192 . 168 . 0 . 51
Subnet Mask	255 . 255 . 255 . 0
Gateway	0 . 0 . 0 . 0

At the bottom of the dialog, there are two buttons: "Set" and "Cancel".

Figure 3.23 – Set Device IP Parameters

The device's new *IP Address*, *Subnet Mask*, and *Gateway* address can be configured. Clicking the **SET** button will cause these new parameters to be written to the device's non-volatile memory.

3.6.2.3 Set Name

This function allows the user to change the PROFINET Device Name of a connected device. When selected, the *Set Device Name* window opens.

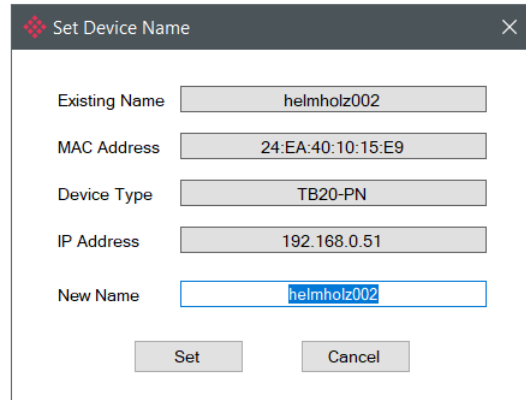

Figure 3.24 – Set Device Name

Clicking the **SET** button will cause the new Device Name to be written to the device's non-volatile memory.

3.6.2.4 Start LED Flash

This function will cause the connected device to flash all its LEDs for a few seconds. This allows the user to identify the physical device.

3.6.2.5 Reset To Factory Defaults

This function will cause the device to reset its current configuration and revert back to its factory default settings.

The user will be prompted to confirm the instruction before the Reset command is sent.

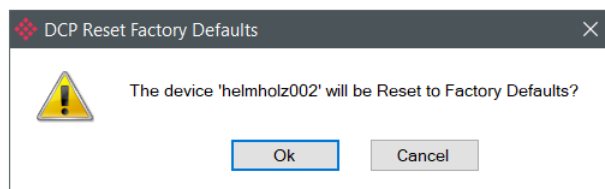

Figure 3.25 – Reset to Factory Defaults

3.7 Adding PROFINET Devices

In addition to adding PROFINET devices online, using the aforementioned *DCP Discovery* approach, devices can also be added manually.

To add a device, right-click on the **PROFINET DEVICES** item in the project tree and select the **ADD PROFINET DEVICE** option.

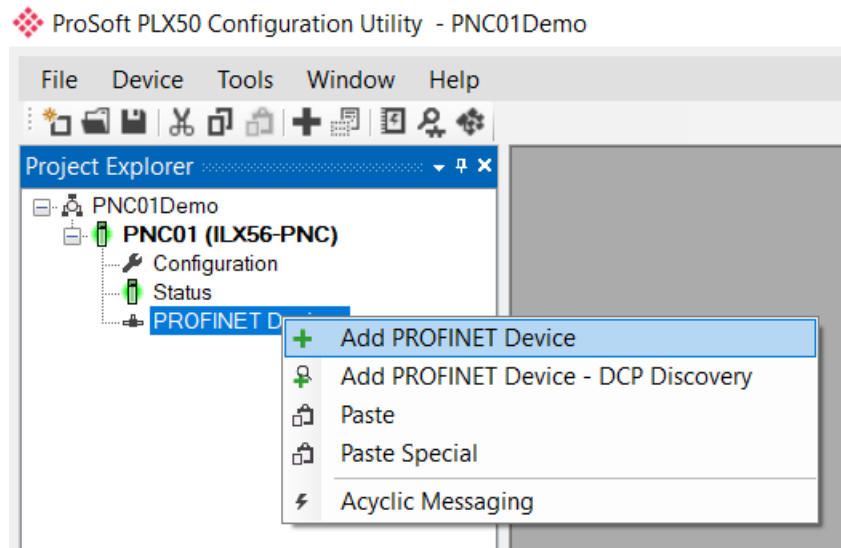

Figure 3.26 – Adding a PROFINET Device

The PROFINET GSDML Management window will open displaying all the available GSDML files and their associated devices. The selection can be narrowed by entering filter criteria for one or more of the following attributes:

- Vendor
- Description
- Ident.
- Order Number
- GSDML Filename

Note: The entered criteria can be removed by clicking on the **RESET** button.

Note: When entering filter criteria, it is recommended to use the wildcard character “*”, before and after the criteria text. Example: ***1234-GSK***

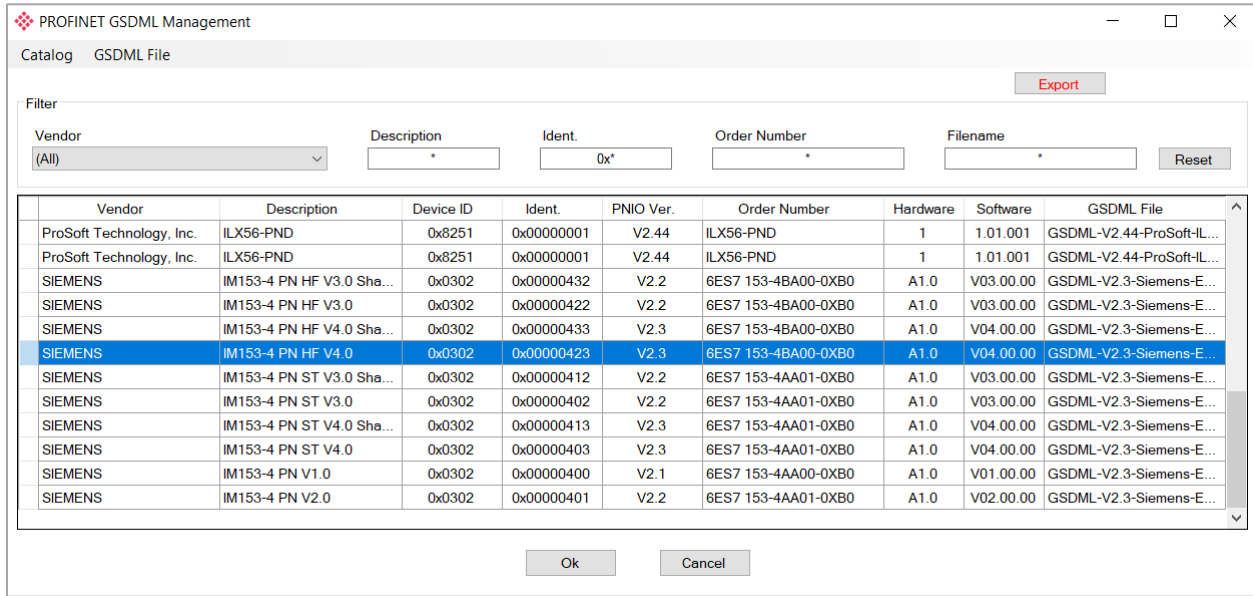

Figure 3.27 – Selecting a PROFINET Device

Once a device has been selected, click the **OK** button to continue the device instantiation process. The *Device Configuration* window will open.

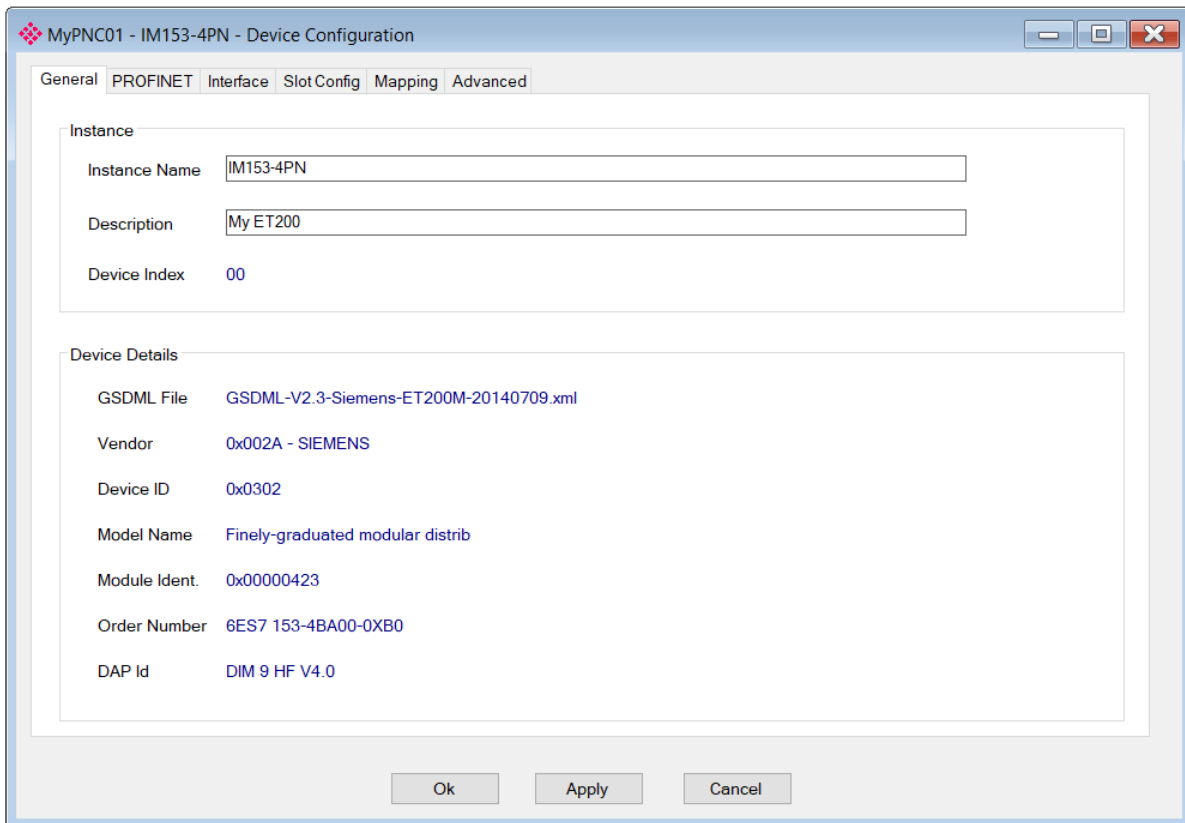

Figure 3.28 – PROFINET Device Added

3.7.1 General

The *General* tab contains the name, description, index, and details of the PROFINET device.

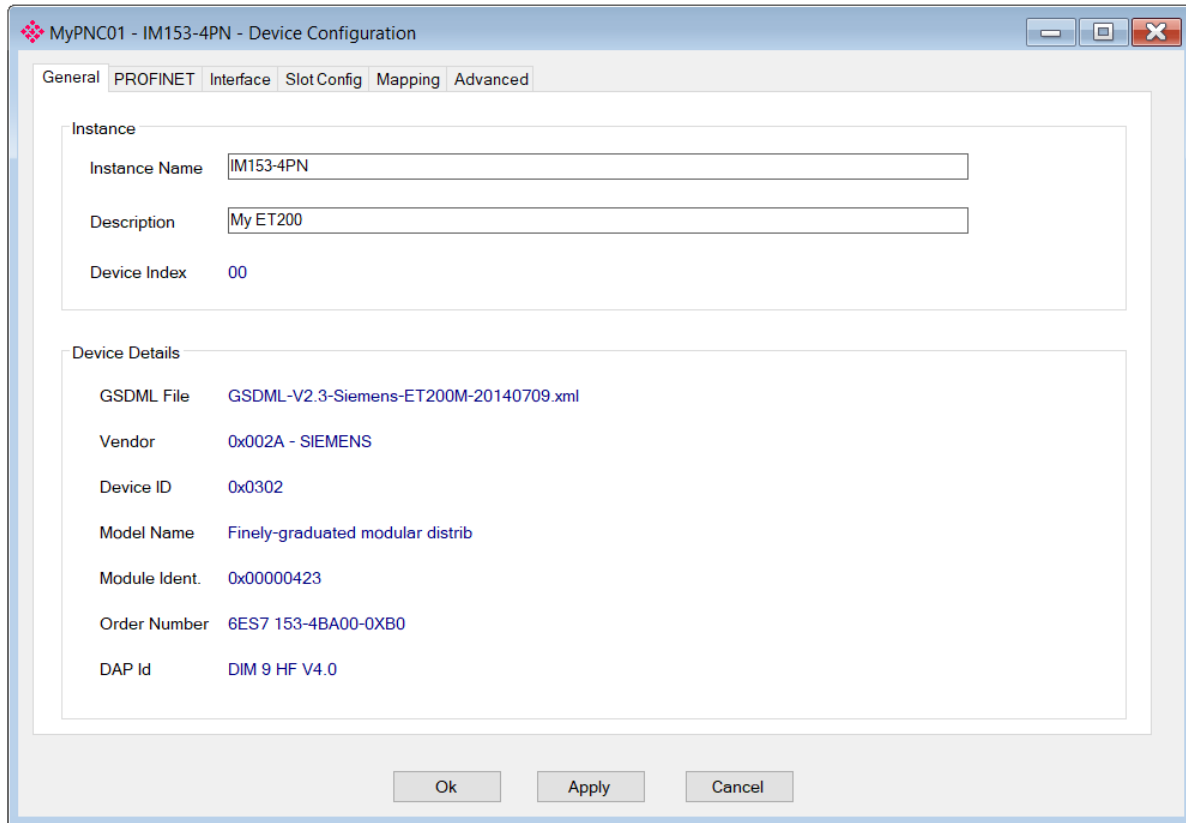

Figure 3.29 – Device General configuration parameters

The *General* configuration consists of the following parameters:

Parameter	Description
<i>Instance</i>	
Instance Name	The device instance name which will be used to create the Tag names and UDTs in Logix.
	Note: The PROFINET <i>Device Name</i> is synchronized to the <i>Instance Name</i> when the <i>Independent Device Name</i> option is not selected.
Description	A user defined description for the device.
Device Index	The Index (0 to 63) of the Device within the module's configuration.

Table 3.3 – Device General configuration parameters

3.7.2 Device PROFINET Configuration

The PROFINET tab contains the general PROFINET configuration parameters.

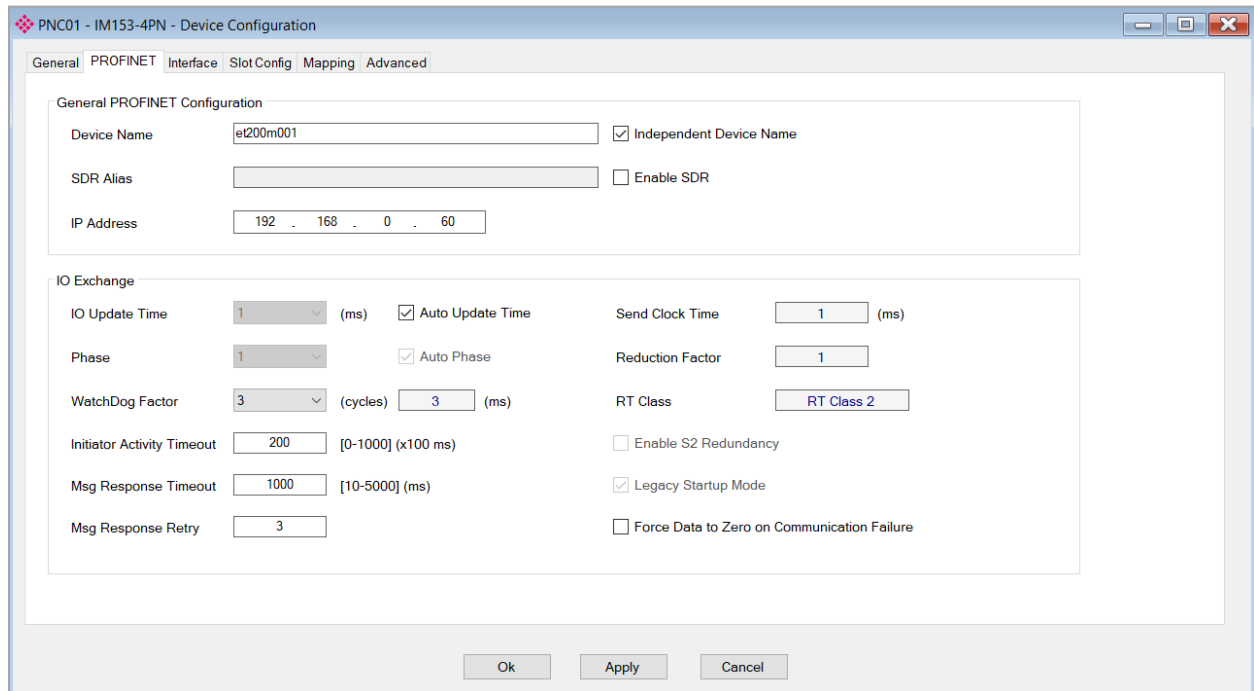

Figure 3.30 –Device PROFINET configuration parameters

The PROFINET configuration consists of the following parameters:

Parameter	Description
<i>General PROFINET Configuration</i>	
Device Name	The name used to identify the device on the PROFINET network. Note: This name will be synchronized with the <i>Instance Name</i> unless the <i>Independent Device Name</i> option is selected.
Independent Device Name	This option allows the PROFINET <i>Device Name</i> to be configured independently from the device <i>Instance Name</i> .
SDR Alias	The Simple Device Replacement Alias to be used for automatic Device Name assignment.
Enable SDR	Allows the automatic assignment of the Device Name and network parameters (e.g., IP address) for an IO device in case of device failure and replacement. The assignment makes use of the SDR Alias, typically provided by the Ethernet switch.
IP Address	The IP address of the PROFINET device.
<i>I/O Exchange</i>	
I/O Update Time	The rate (in milliseconds) at which IO data is exchanged with the device. The selection is based on the ILX56-PNC's Send Clock ratio and the allowed Reduction Ratios in the device's GSDML file. Note: If the <i>Auto Update Time</i> option is selected, then this will automatically be assigned.
Auto Update Time	Selecting this option will force the <i>IO Update Time</i> to a recommended value.

Phase	The Phase number, (or send clock cycle), where the IO exchange with the device will occur. The Phase is used to balance the network loading across the macro-cycle. Note: When the <i>Auto Phase</i> option is selected, then the phase is automatically assigned to keep the send clocks as balanced as possible.
Auto Phase	Selecting this option will force the <i>Phase</i> to a recommended value.
WatchDog Factor	The number of consecutive <i>IO Update Time</i> periods (cycles) where no valid IO data is received from the device at which point the controller deems the device to be offline.
Initiator Activity Timeout	The number of milliseconds allowed before the first cyclic data is required from the PROFINET device, after cyclic communication connection establishment.
Send Clock Time	Displays the current ILX56-PNC's Send Clock Time. (Read Only).
Reduction Factor	The currently selected Clock Reduction Factor. (Read Only). The <i>Reduction Factor</i> is based on the selection of <i>IO Update Time</i> .
Msg Response Timeout	The maximum amount of time the controller will wait for a reply from a device after sending a message request. Note: Must be between 10 to 5000 ms.
Msg Response Retry	The maximum number of times the controller will retry a message request.
Enable S2 Redundancy	Enables S2-Redundancy. (See the S2 Redundancy section.) Note: To enable S2 Redundancy, the PROFINET device must support it.
Legacy Startup Mode	The currently selected Connection Startup Mode based on the GSDML file. (Read Only).
Force Data to Zero on Communication Failure	When this option is selected, and a device is no longer exchanging IO data, then the input data will be forced to zero.
RT Class	The currently selected RT Class for the connection based on the GSDML file. (Read Only).

Table 3.4 – Device PROFINET configuration parameters

3.7.3 Interface

The *Interface* tab contains the PROFINET device parameters.

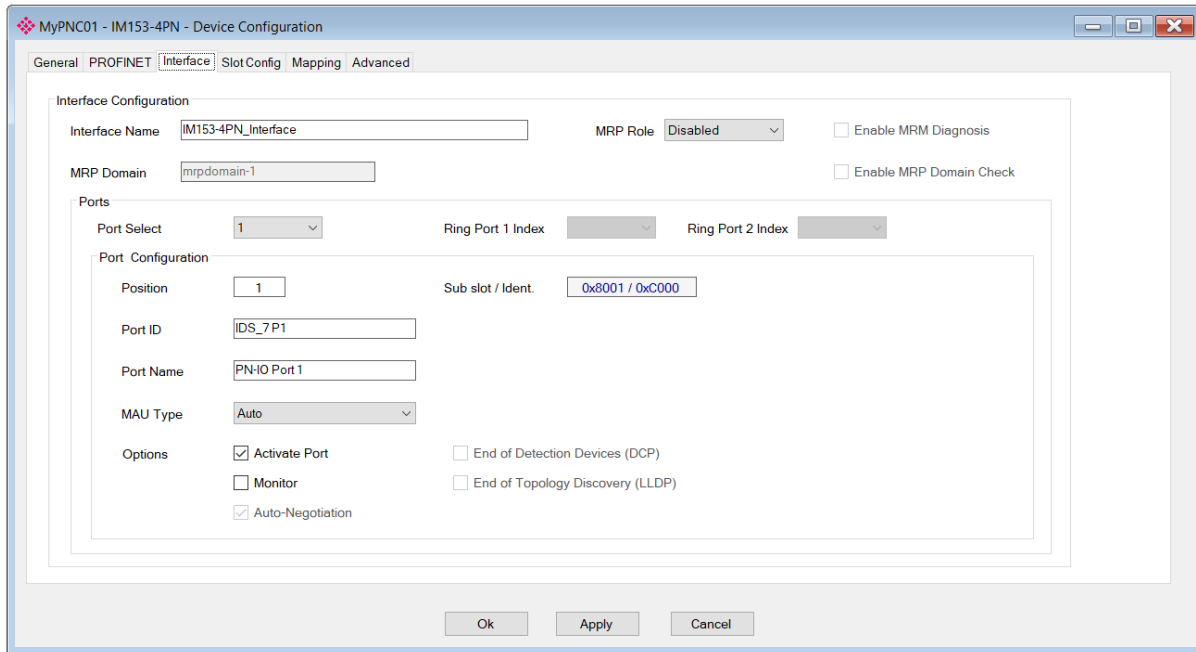

Figure 3.31 – Device Interface configuration parameters

The Interface configuration consists of the following parameters:

Parameter	Description
<i>Interface Configuration</i>	
Interface Name	The user assigned name for the interface.
MRP Role	The Media Redundancy Protocol (MRP) Role of the device, either: Disabled: The device is not located in an MRP Ethernet ring. Client: The device is located in an MRP Ethernet ring, but is not a manager. Manager: The device is located in an MRP Ethernet ring and has been assigned the manager role. See the section on MRP for more information.
MRP Domain	The identifier for the logical MRP collection. The controller (ILX56-PNC) and the devices in an MRP ring must all have the same MRP Domain configured.
Enable MRM Diagnosis	This option enables the device, when operating as a Media Redundancy Protocol Manager (MRM), to provide MRP diagnostics.
Enable MRP Domain Check	This option enables the device to check and report an inconsistent MRP Domain name.
<i>Ports</i>	
Port Select	This combo box allows the user to select between the different device ports. Once a <i>Port</i> is selected, then all the items in the <i>Port Configuration</i> group will be displayed for that specific port.

Ring Port 1 Index Ring Port 2 Index	Ring Port 1 and 2 Index is used to select which ports on the device will be used for the MRP ring.
Note: This is typically only relevant for devices with more than 2 ports.	
Port Configuration	
Position	The selected port number. (Port Select)
Port ID	The ID assigned to the port.
Port Name	The user assigned name to the port.
MAU Type	The Media Attachment Unit Type selected for the port. This typically sets the required speed (e.g. 10 / 100 Mb/s) and duplex of the port. The options are based on the device's GDML file.
Sub slot / Ident.	The subslot and Identifier used to access the port object.
Activate Port	This option determines whether the port should be disabled or not. The availability of the option depends on the device's GSDML file.
Monitor	This option determines whether the port should be monitored for a change in link status. When selected the device will report a change in the ports link status. The availability of the option depends on the device's GSDML file.
Auto-Negotiation	When selected, the port will be set to Auto-Negotiate, where the MAU automatically determines the best speed and duplex with the remote Ethernet device.
End of Detection Devices (DCP)	When this option is selected, then DCP Discovery frames are not forwarded through this port.
End of Topology Discovery (LLDP)	When this option is selected, then LLDP Discovery frames are not forwarded through this port.

Table 3.5 – Device Interface configuration parameters

3.7.4 Slot Configuration

The *Slot Config* tab contains the module and sub-module slot configuration.

The device’s GSDML file defines the available (Physical) slots, as well the “Plugging Rules” which specify which modules can be added to each slot, and whether they are:

- Fixed – (Cannot be deleted)
- Allowed – (Can be added / deleted)
- Used (added / deleted, Added by default)

When a device is instantiated, all the system and fixed modules and sub-modules are automatically added to the slot configuration.

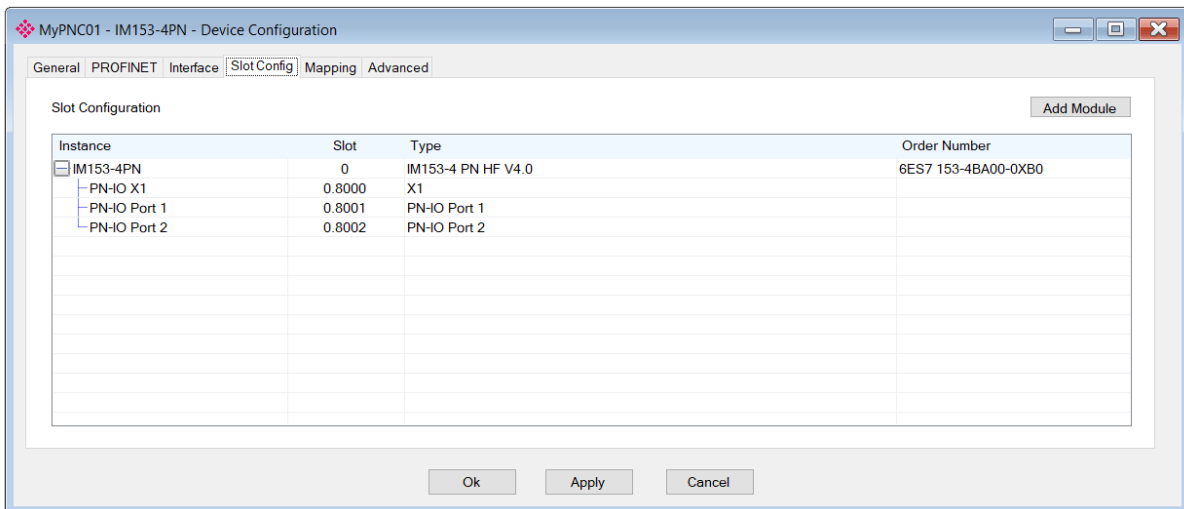

Figure 3.32 –Device Slot configuration

3.7.4.1 Add Module

To add a module, either click on the **ADD MODULE** button in the *Slot Config* tab, or right-click and select the **ADD MODULE** context menu option.

The *Add Module* window will open and list all the available modules from the GSDML file for the particular selected *Slot Number*.

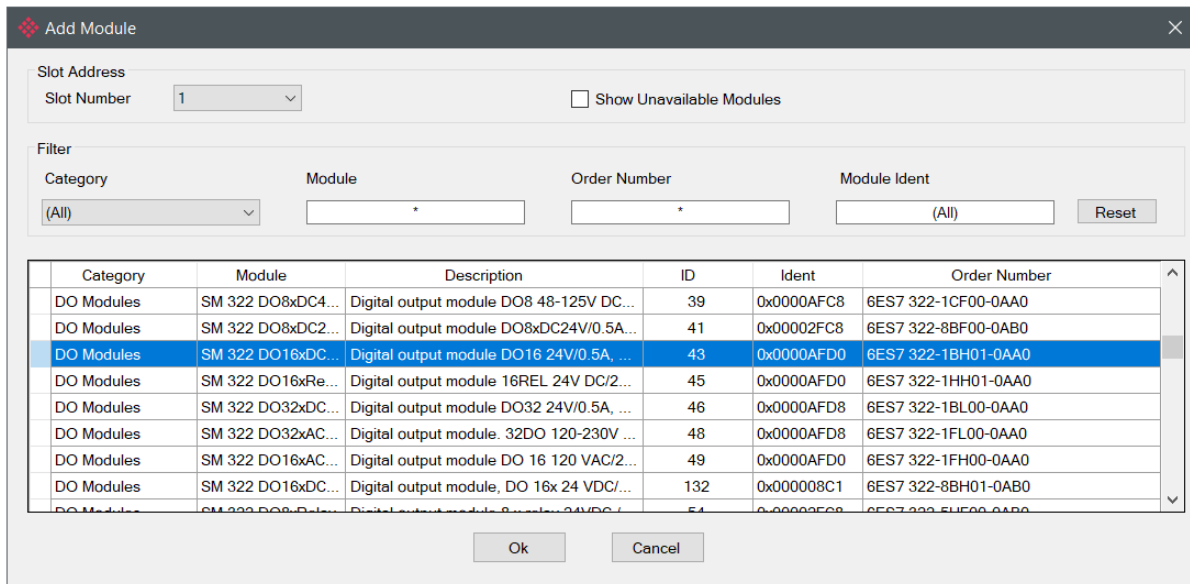

Figure 3.33 – Module Selection

Note: Changing the selected *Slot Number* may change the list of available modules, based on the GSDML Plugging Rules.

The module selection can be narrowed by entering filter criteria for one or more of the following attributes: *Category*, *Module*, *Order Number*, and *Module Ident*

Note: The entered criteria can be removed by clicking on the **RESET** button.

Note: When entering filter criteria, it is recommended to use the wildcard character “ * ”, before and after the criteria text. Example: ***321 DI4***

Once the required module has been selected, click the **OK** button. The selected module will be added to the Slot configuration.

Instance	Slot	Type	Order Number
IM153-4PN	0	IM153-4 PN HF V4.0	6ES7 153-4BA00-0XB0
PN-IO X1	0.8000	X1	
PN-IO Port 1	0.8001	PN-IO Port 1	
PN-IO Port 2	0.8002	PN-IO Port 2	
SM 322 DO16xDC24V/0.5A	1	SM 322 DO16xDC24V/0.5A	6ES7 322-1BH01-0AA0

Figure 3.34 – Slot configuration

3.7.4.2 Configure Module

When a module has its associated configuration parameters, the parameters can be edited by right-clicking on the specific module and selecting the **CONFIGURE MODULE** menu option.

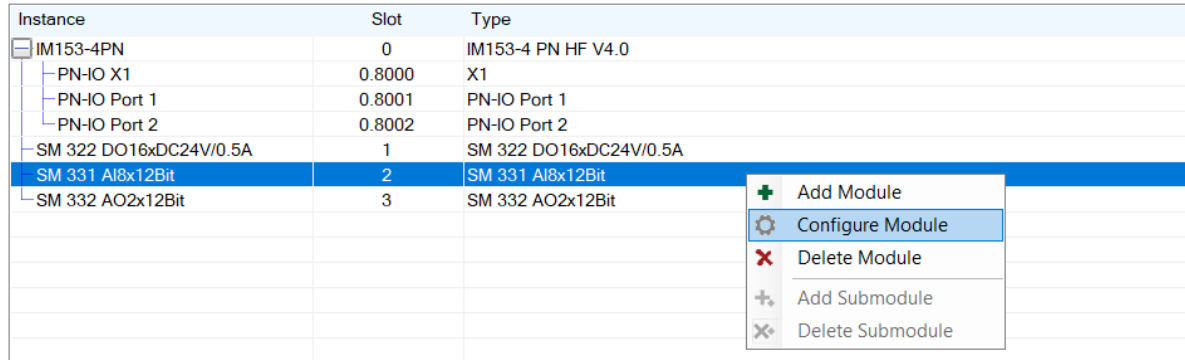

Figure 3.35 – Configure Module option

The *Parameter Editor* window will open. The list of parameters and their associated enumerated configuration options are derived from the GSDML file.

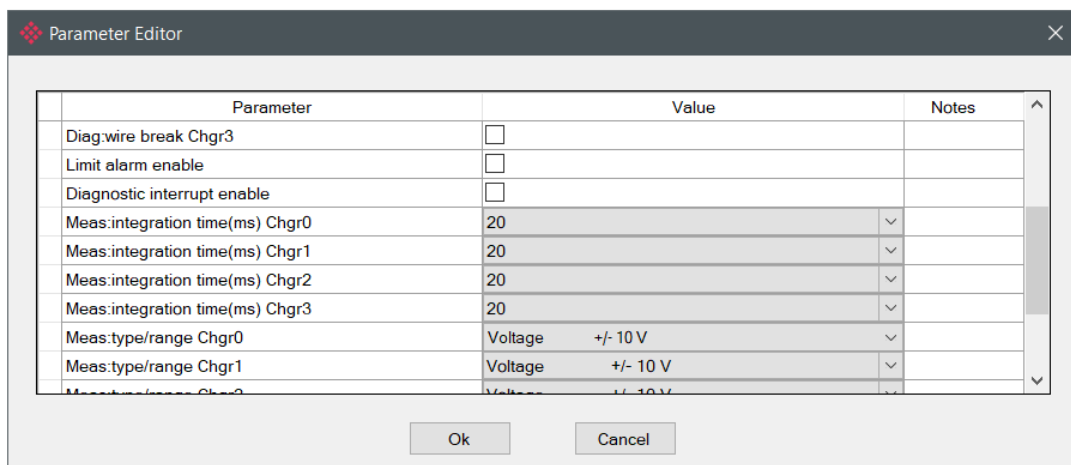

Figure 3.36 –Module Parameter Editor

Once the parameter configuration is complete, click the **OK** button to accept the changes.

3.7.4.3 Delete Module

To delete a module, right-click on the module and select the **DELETE MODULE** menu option.

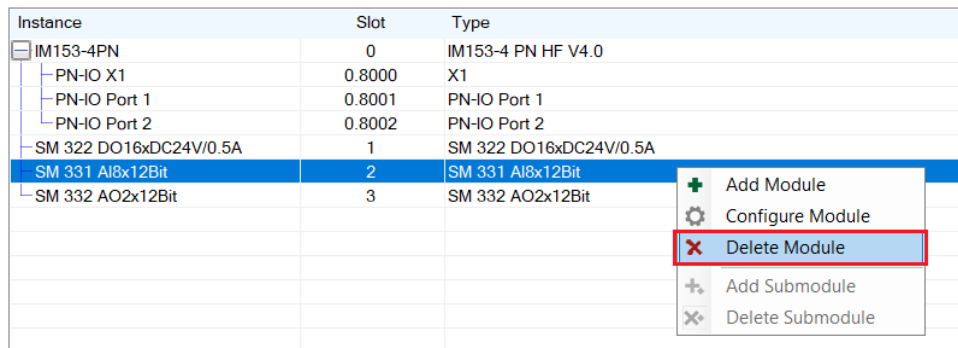

Figure 3.37 – Delete Module

3.7.4.4 Add Submodule

Some module's support submodules. To add a submodule to an existing module, right-click on the module and select the **ADD SUBMODULE** option.

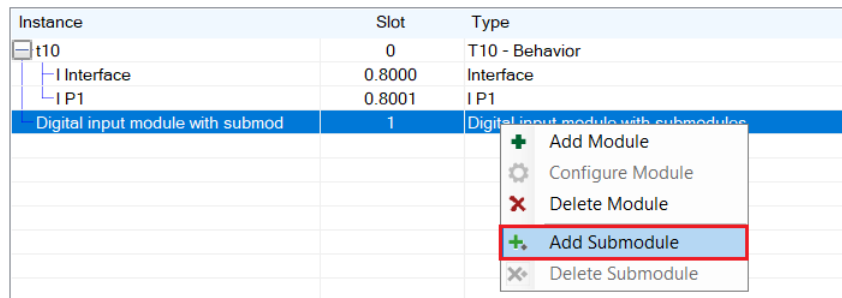

Figure 3.38 – Add Submodule

The *Add Submodule* selection window will open and list all the available submodules from the GSDML file, for the particular selected *Subslot Number*.

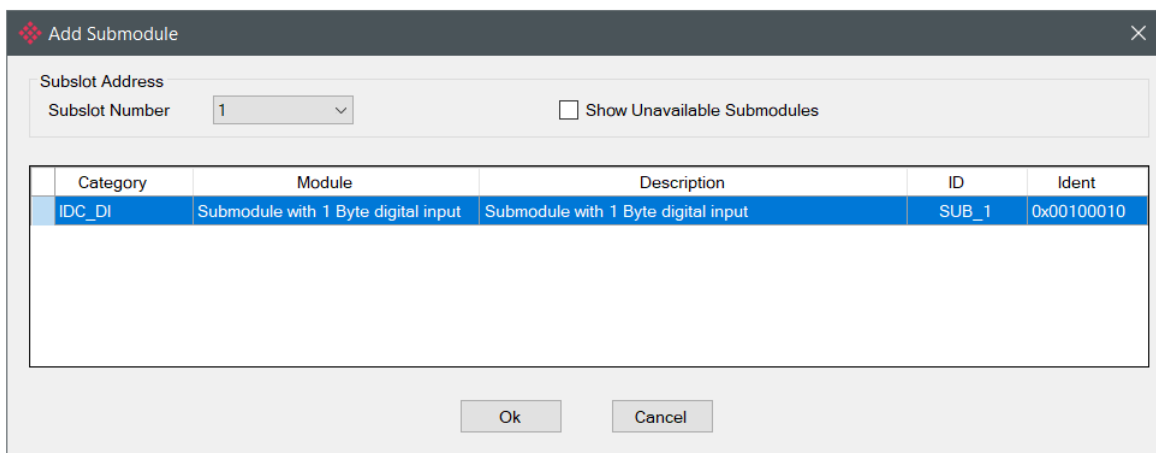

Figure 3.39 – Submodule Selection

Note: Changing the selected *Subslot Number* may change the list of available submodules, based on the GSDML Plugging Rules.

Once the required submodule has been selected, click the **OK** button. The selected submodule will be added to the Slot configuration.

Instance	Slot	Type	Order Number
t10	0	T10 - Behavior	12345-0095
└─ I Interface	0.8000	Interface	
└─ I P1	0.8001	I P1	
└─ Digital input module with submod	1	Digital input module with submodules	
└─ Submodule with 1 Byte digital...	1.1	Submodule with 1 Byte digital input	

Figure 3.40 – Submodule in Slot configuration

3.7.4.5 Delete Submodule

To delete a submodule, right-click on the submodule and select the **DELETE SUBMODULE** menu option.

Instance	Slot	Type	Order Number
t10	0	T10 - Behavior	12345-0095
└─ I Interface	0.8000	Interface	
└─ I P1	0.8001	I P1	
└─ Digital input module with submod	1	Digital input module with submodules	
└─ Submodule with 1 Byte digital...	1.1	Submodule with 1 Byte digital input	

- + Add Module
- ⚙ Configure Module
- ✕ Delete Module
- + Add Submodule
- ✕ Delete Submodule

Figure 3.41 – Delete Submodule

3.7.5 Mapping

The *Mapping* tab displays the relationship between the PROFINET device's input and output data and the resulting tag UDT structure in Logix.

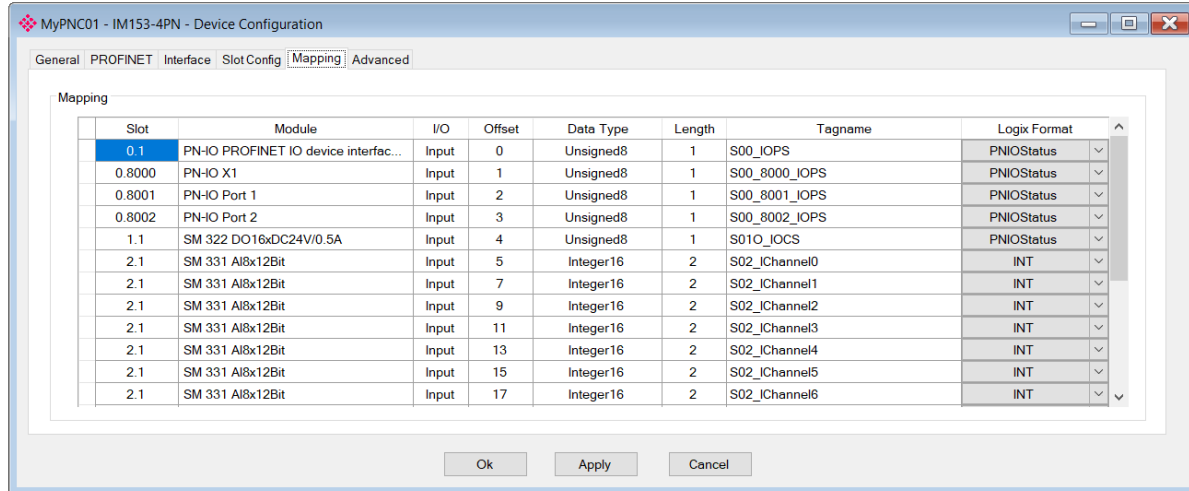

Figure 3.42 – Device Mapping configuration

The items in the Mapping configuration are automatically added and removed when a module/submodule is added or removed.

The mapping columns are fixed except for the *Tagname* and *Logix Format* fields that can be manipulated by the user.

The Mapping configuration table contains the following columns:

Column	Description
Slot	The slot or sub-slot position of the module or submodule. (Read only)
Module	The name of the module or submodule. (Read only)
I/O	The direction of the data flow. (Read only) Input: From device to controller Output: From controller to device.
Offset	The byte offset in the PROFINET device data structure (Read only)
Data Type	The PROFINET data type. (Read only)
Length	The data length in bytes. (Read only)
Tagname	The user configurable Tagname for the data point. This Tagname is used to generate the device specific UDT (user defined data type) that will be imported into Logix.

Note: The Tagname must conform to the requirements of Logix tagnames / UDT member names. (No spaces or extended characters.)

Note: Each Tagname must be unique across the entire PROFINET device.

Logix Format	<p>The data format to be used for the Logix device specific UDT. Depending on the corresponding PROFINET data type, the following options are available:</p> <ul style="list-style-type: none">• None (The item is excluded from the Logix structure.)• BOOL• SINT• INT• DINT• LINT• REAL• LREAL• SINTArray• PNIOStatus - A specific UDT to describe both the:<ul style="list-style-type: none">○ IOPS – Input Output Object Provider Status○ IOCS – Input Output Object Consumer Status
--------------	--

Table 3.6 – Device Mapping configuration columns

3.7.6 Advanced

The *Advanced* tab contains the language, CRC, and assembly parameters.

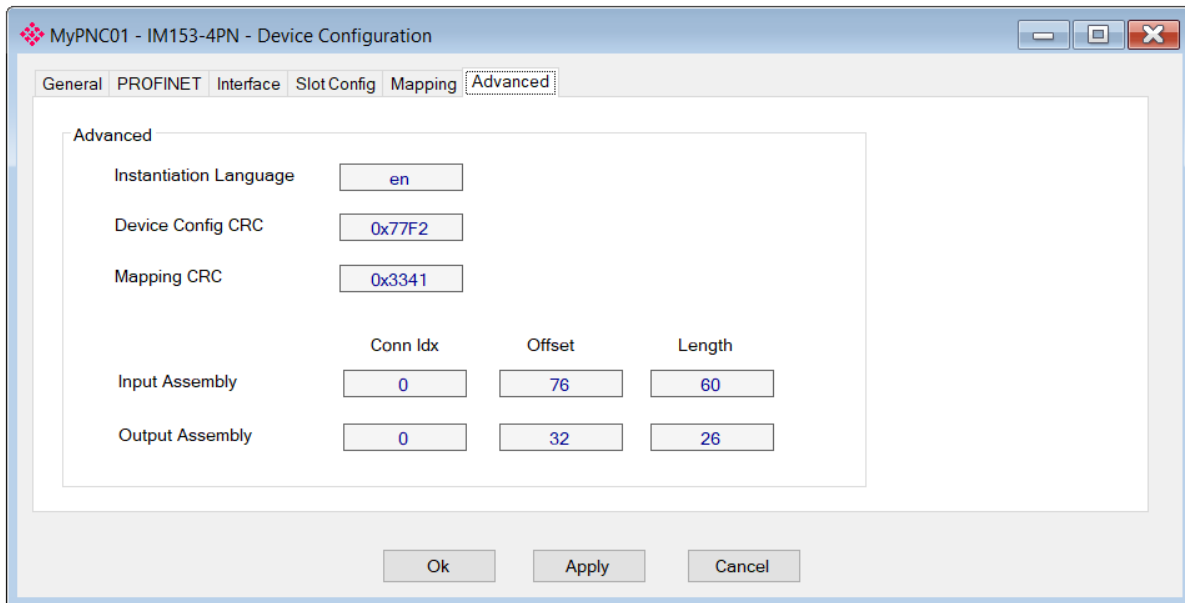

Figure 3.43 – Device Advanced configuration

The *Advanced* tab contains the following parameters:

Parameter	Description
Instantiation Language	The language selected when the device was instantiated.
Device Config CRC	A checksum calculated on the entire device's configuration.
Mapping CRC	A checksum of the device configuration associated with data mapping.
<i>Input Assembly</i>	
Conn Idx	The ILX56-PNC's connection index where this device's input data starts.
Offset	The ILX56-PNC's connection offset where this device's input data starts.
Length	The total input assembly size (bytes) required by the device.
<i>Output Assembly</i>	
Conn Idx	The ILX56-PNC's connection index where this device's output data starts.
Offset	The ILX56-PNC's connection offset where this device's output data starts.
Length	The total output assembly size (bytes) required by the device.

Table 3.7 – Device Advanced configuration parameters

3.8 Studio 5000 Configuration

There are two profile options for integrating the ILX56-PNC into Logix:

- Standard (ILX56-PNC) Add-On-Profile (AOP)
- Generic Profile (1756-Module)

Note: The minimum Studio 5000 version that can be used is V16. The preferred implementation makes use of an Add-On Profile (AOP) for the 1756 Backplane, which requires V30 and newer. Versions prior to V30 require the use of a Generic Profile.

Note: The choice of profile selected in Studio 5000 / RSLogix 5000 must match that configured in the PLX50 Configuration Utility.

3.8.1 Standard Add-On Profile

3.8.1.1 Installing the Add-On Profile (AOP)

Before the ILX56-PNC module AOP can be added into the Logix I/O tree, it must first be installed on that system. The user will need to download the AOP from www.prosoft-technology.com. Once downloaded extract the zip file, run the *MPSetup.exe* file, and follow the on-screen instructions.

3.8.1.2 Add Module to I/O Configuration

To add the AOP in the Logix IO Configuration (tree), right-click on the **1756 BACKPLANE** and select the **NEW MODULE** option.

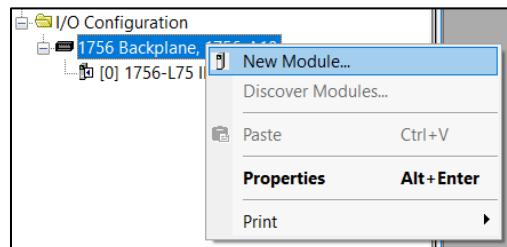

Figure 3.44 – Adding a New Module

The *Select Module Type* dialog will open. Enter the ILX56-PNC name into the catalog filter to find the ILX56-PNC AOP.

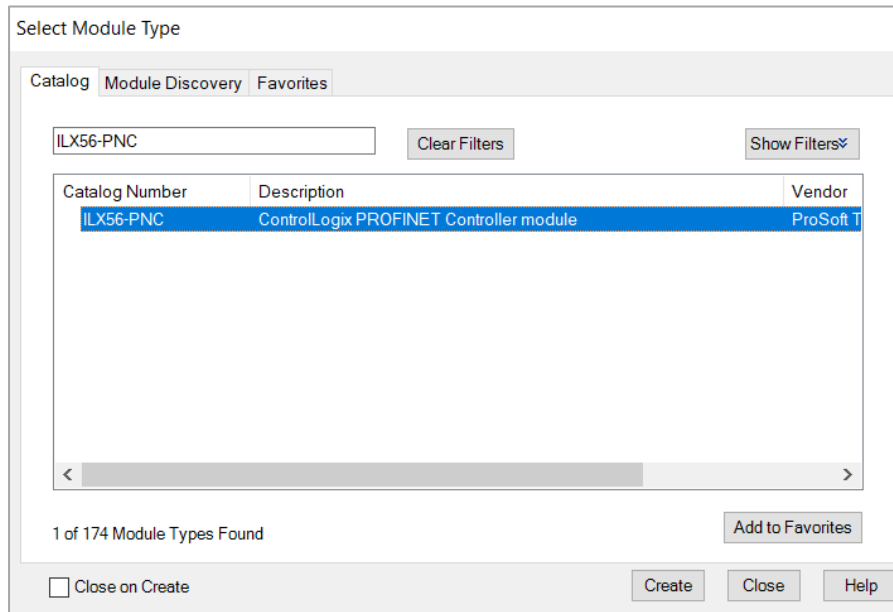

Figure 3.45 – Selecting the module

Select the ILX56-PNC and click **CREATE**. The *New Module* dialog will open, where the user must configure the module *Name* and *Slot* as a minimum to complete the instantiation.

Note: The module *Name* must match the *Instance Name* configured in the PLX50 Configuration Utility.

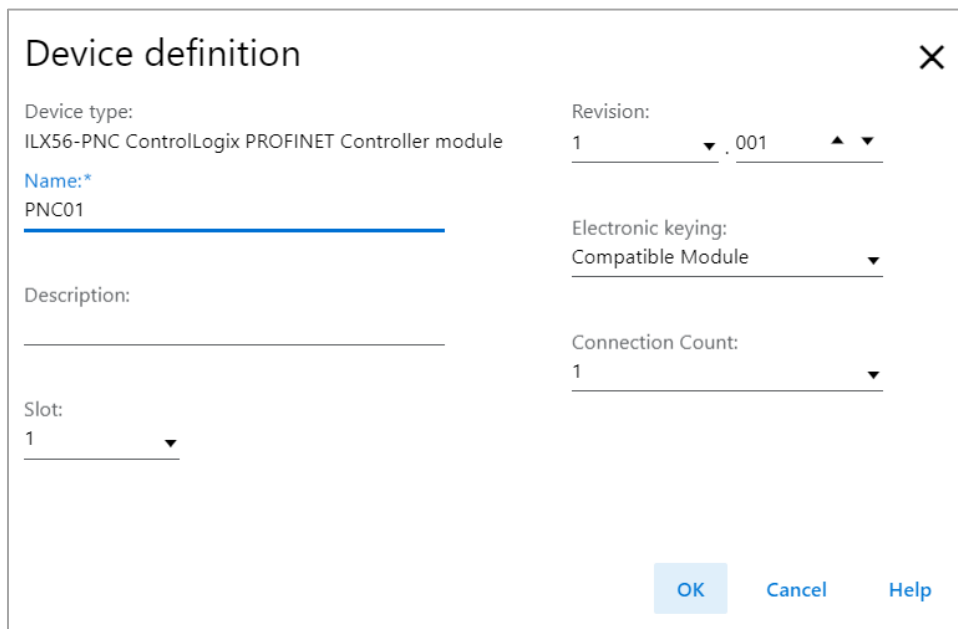

Figure 3.46 – Module instantiation

Once the instantiation is complete the module will appear in the Logix IO tree.

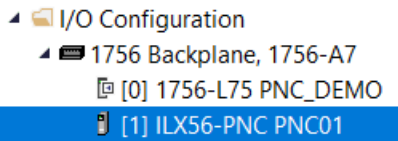

Figure 3.47 – Logix IO tree

The *Module Defined Data Types* will be automatically created during the instantiation process.

3.8.1.3 PLX50 Configuration Utility Project File

The ILX56-PNC AOP allows the user to save the PLX50 Configuration Utility project file in the AOP as well as launch PLX50 Configuration Utility from the AOP.



Figure 3.48 – AOP - PLX50 Configuration Utility

When no PLX50 Configuration Utility project has been defined, the user can *Browse* for an existing PLX50 Configuration Utility project. If no PLX50 Configuration Utility project has been created, the user can manually enter in the project file name in the *PLX50 Configuration Utility Project File* textbox and select the **LAUNCH PLX50 CONFIGURATION UTILITY** button.

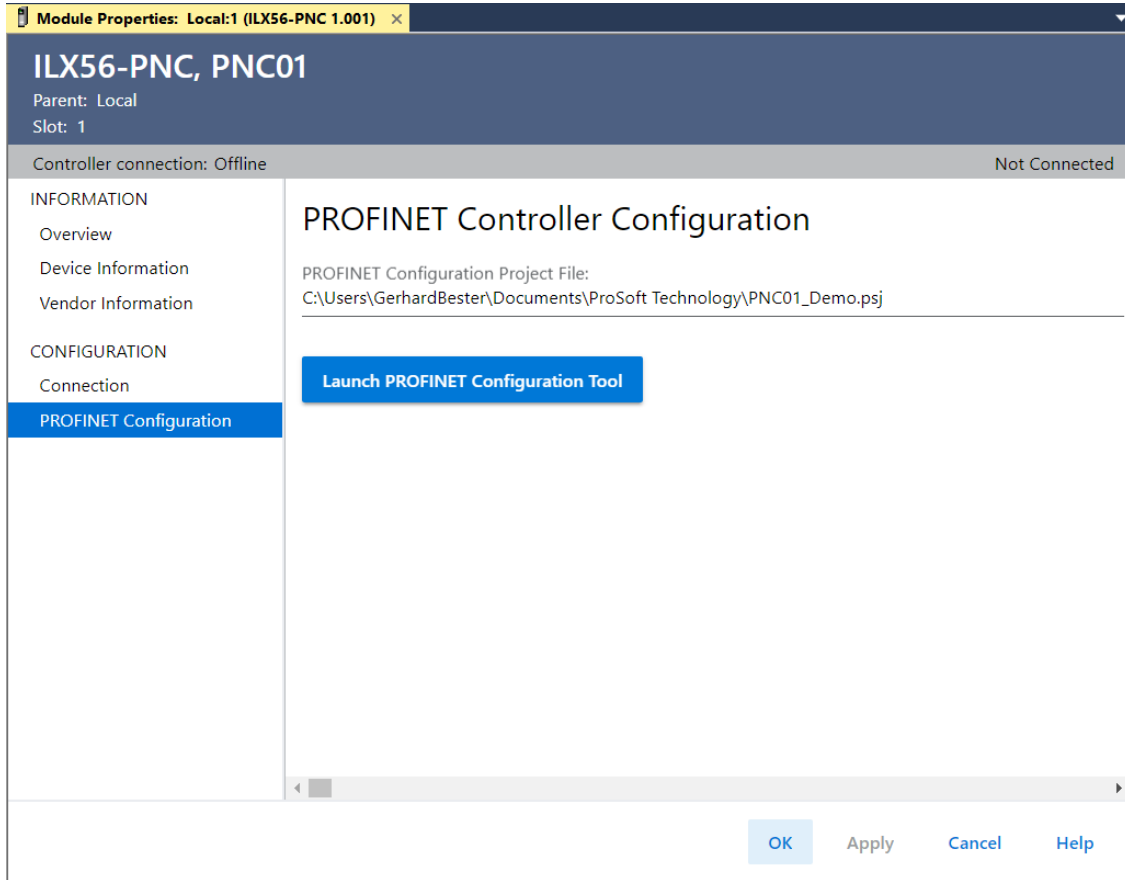

Figure 3.49 – AOP – Launch PLX50 Configuration Utility

Note: Once the file name has been entered, the user will need to click **APPLY** before the **LAUNCH PLX50 CONFIGURATION UTILITY** button will become available.

3.8.2 Generic Profile

For older versions of Studio 5000 / RSLogix 5000, the use of the *Generic Profile* approach is required.

To add the **Generic 1756-Module** profile in the Logix *IO Configuration* (tree), right-click **1756 BACKPLANE** and select the **NEW MODULE** option.

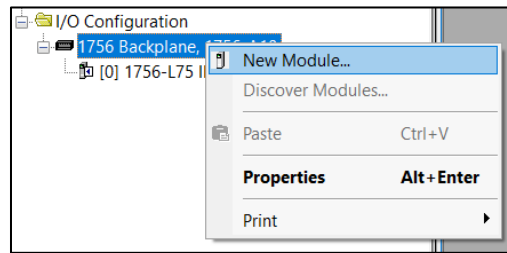

Figure 3.50 – Adding a New Module

The *Select Module Type* dialog will open. The *Module Type Category Filters* search field can be used search for “**Generic**” modules as shown in the following figure.

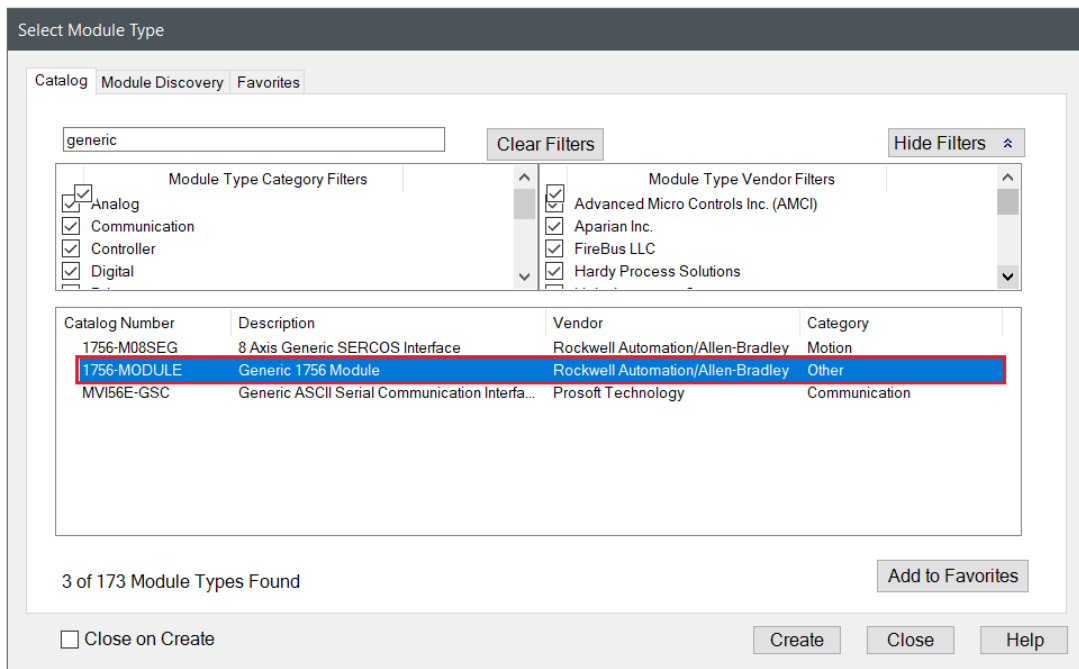

Figure 3.51 – Selecting the Generic module

Locate and select the **1756-MODULE** and click the **CREATE** button. The *New Module* dialog will open, where the user must configure the module *Name*, *Slot*, and *Connection Parameters* as a minimum to complete the instantiation.

Note: The module *Name* must match the *Instance Name* configured in the PLX50 Configuration Utility.

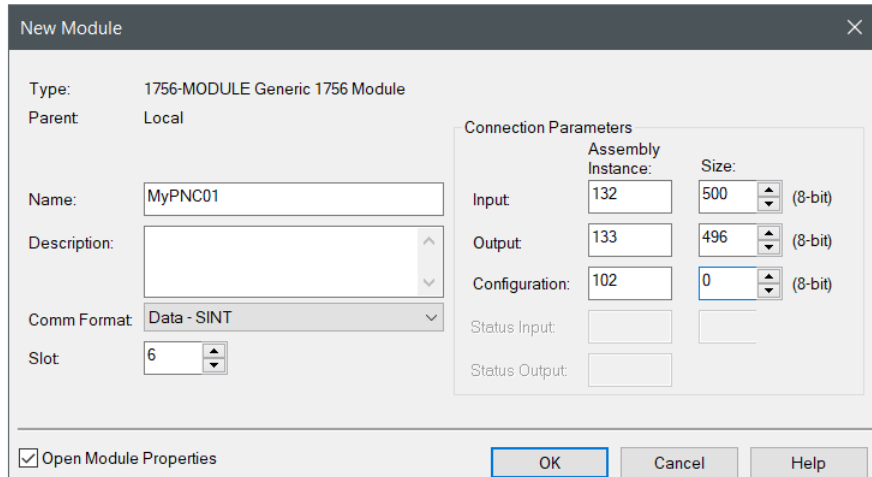

Figure 3.52 – Generic Module instantiation

The required *Connection Parameters* are as follows:

Parameter	Description
Input Instance	132
Input Size	500 (bytes)
Output Instance	133
Output Size	496 (bytes)
Configuration Instance	102
Configuration Size	0 (bytes)

Table 3.8 – Generic Connection Parameters

Once the instantiation is complete the module will appear in the Logix IO tree.

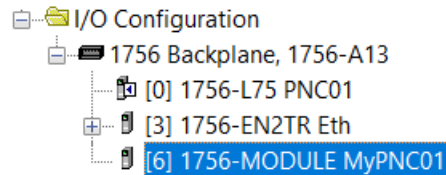

Figure 3.53 – Logix IO tree

3.9 Logix Mapping

The PLX50 Configuration Utility will generate the required UDTs and Routines to map the PROFINET input and output data. The user will need to generate the required Logix and UDTs by right-clicking on the module in the PLX50 Configuration Utility and selecting the **GENERATE LOGIX L5X** option.

Note: The user will need to ensure that the Logix Base Tag is correct for the generated Logix L5X code to work. The base tag will be the tag name for the module input and output assemblies in the Logix controller owning the module.

For example, if the ILX56-PNC is in the same local rack as the Logix controller owning it, the Logix Base Tag will be *Local:xx* (where *xx* is the slot number of the module). Below is an example where the ILX56-PNC is in slot 1 of the local rack connected to the Logix controller in the same rack.

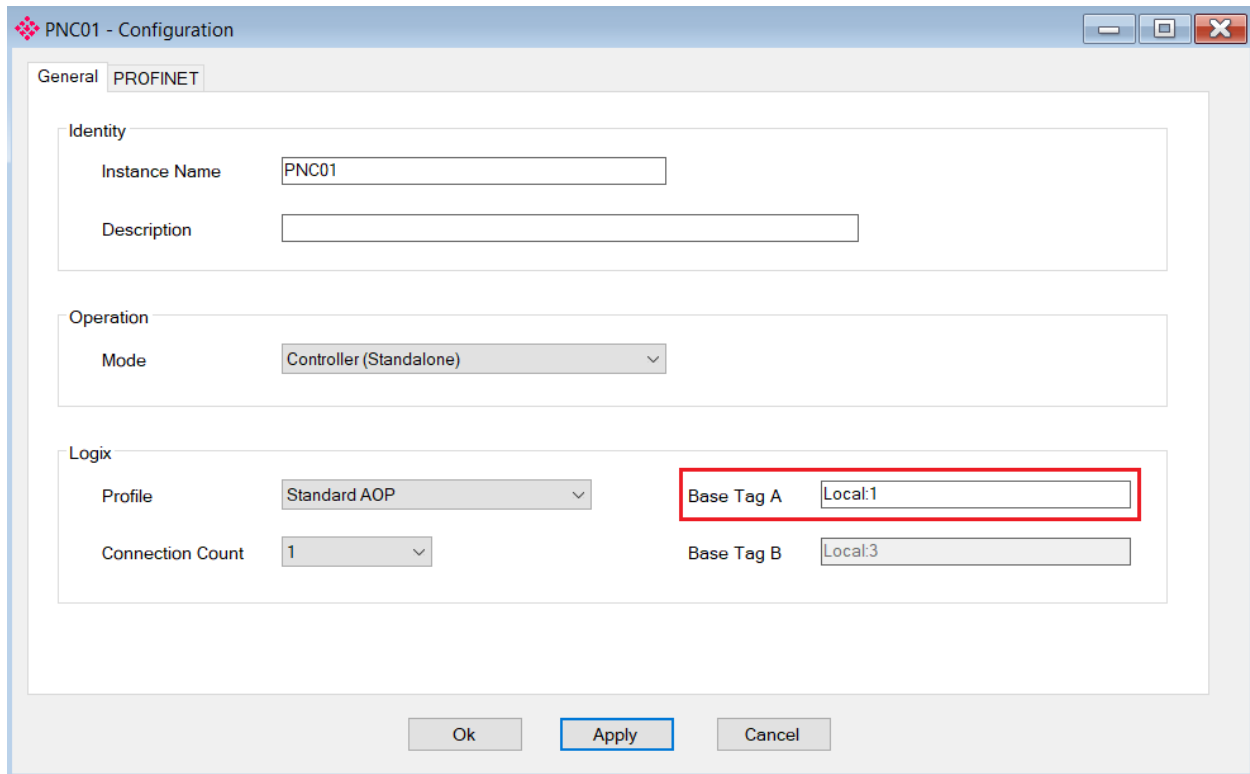

Figure 3.54 – Logix Base tag assignment in PLX50 Configuration Utility

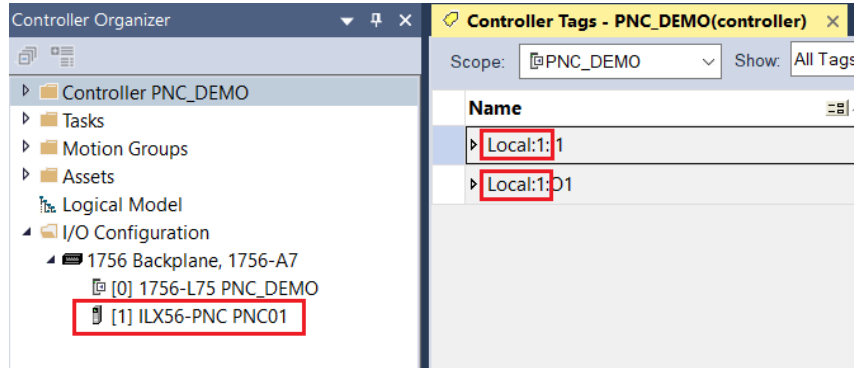

Figure 3.55 – Logix Base tag assignment in Studio 5000

If the module is in a remote rack, the user will need to enter the Logix Base Tag based on the name of the remote rack (see the example below):

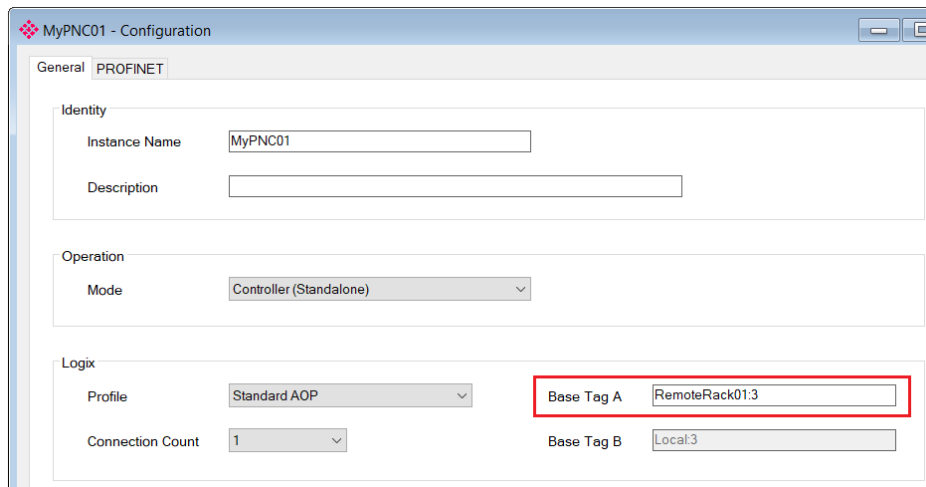

Figure 3.56 – Logix Base tag assignment in PLX50 Configuration Utility

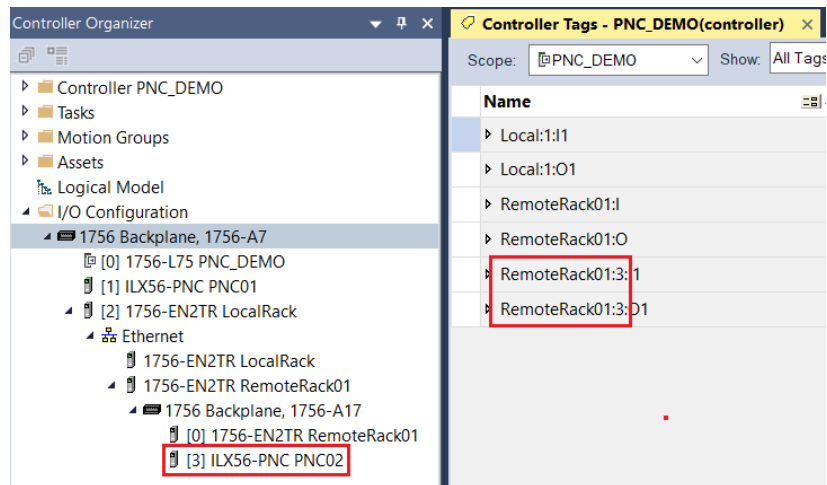

Figure 3.57 – Logix Base tag assignment in Studio 5000

To generate the mapping Logix L5X file, right-click on the ILX56-PNC module and select the **GENERATE LOGIX L5X** option.

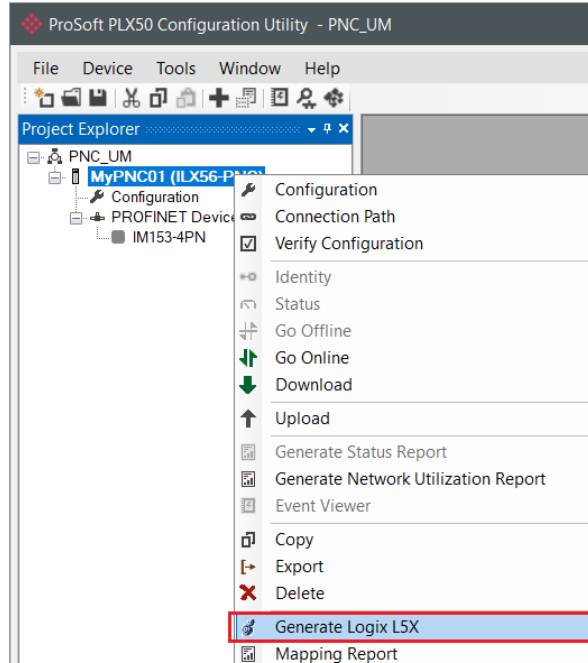

Figure 3.58 – Selecting Generate Logix L5X

The user will then be prompted to select a suitable file name and path for the L5X file.

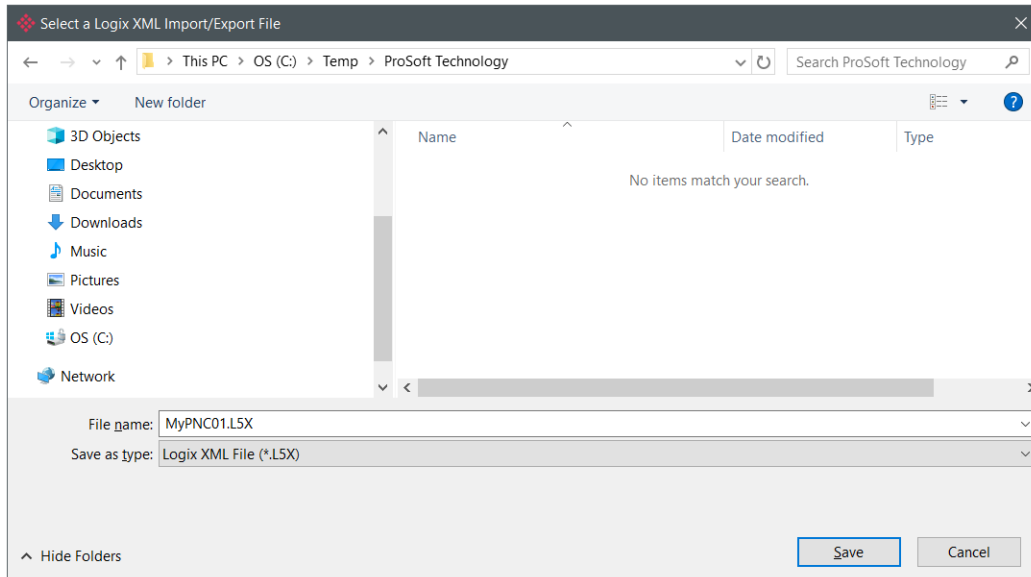

Figure 3.59 – Selecting the Logix L5X file name.

This L5X file can now be imported into the Studio 5000 project by right-clicking on a suitable **PROGRAM**, then **ADD > IMPORT ROUTINE**.

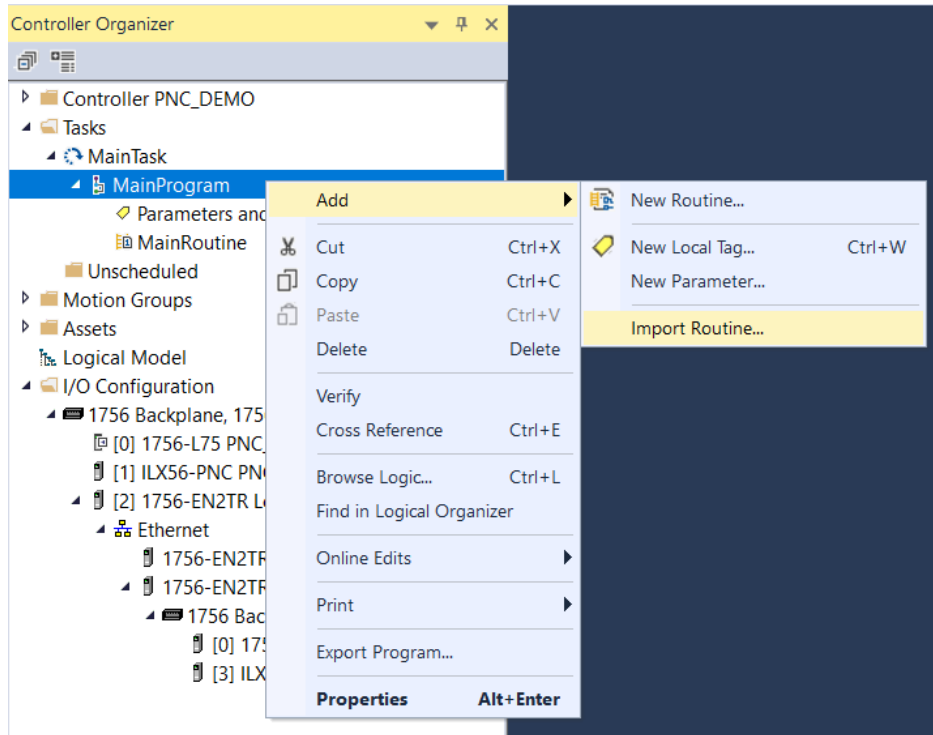

Figure 3.60 – Importing the L5X file into Studio 5000

In the file open dialog, select the previously created L5X file and press **OK**.

The import will create the following:

- Mapping Routine
- Multiple UDT (User-Defined Data Types)
- Multiple Controller Tags

Since the imported mapping routine is not a *Main Routine*, it will need to be called from the current *Main Routine*.



Figure 3.61 – Calling the mapping routine

The following shows an example of the items created by importing the L5X file.

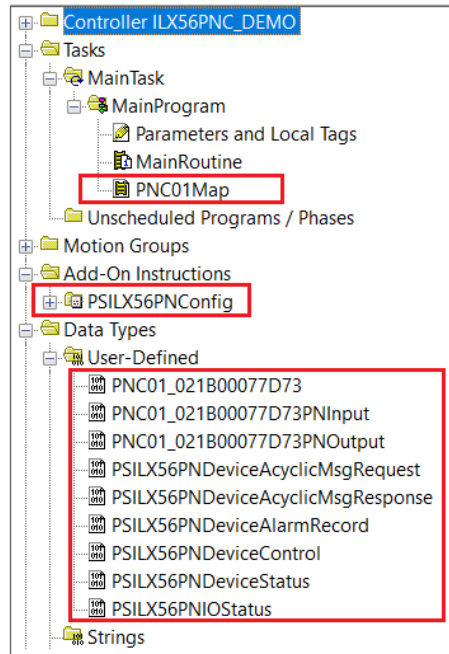

Figure 3.62 – Imported Logix Objects

A number of ILX56 specific (UDT) tags are created for both the ILX56-PNC Controller as well as the configured PROFINET devices. These structures are described in the following section.

For each PROFINET device, a ladder-logic rung is created to map the input/output data to and from the device to the Logix controller. The rung also includes an AOI to map the expected device IP address and device mapping (CRC) checksum. This enforces data integrity between the configuration in the ILX56-PNC and that which the Logix application is expecting.

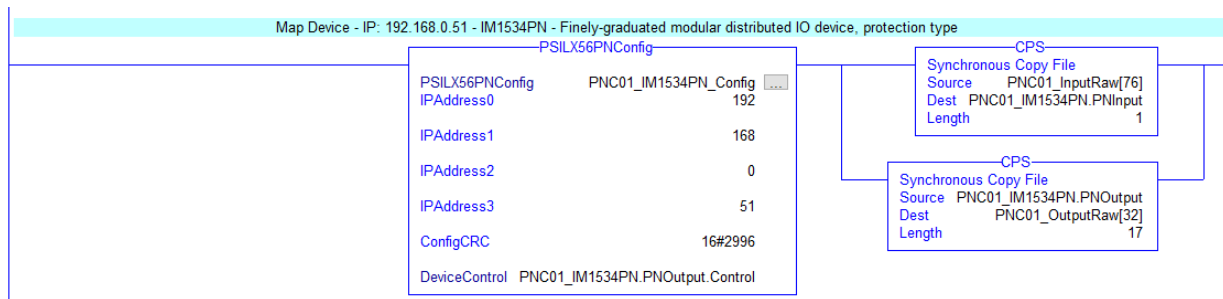

Figure 3.63 – Typical Device Mapping Rung.

4 SD Card

The ILX56-PNC supports an SD Card for disaster recovery. The SD Card can be pre-loaded with the required firmware and/or application configuration.

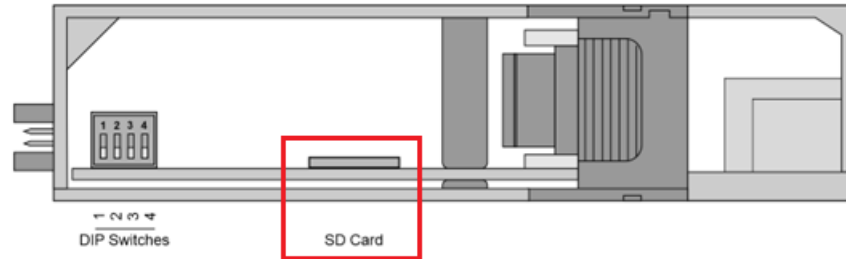

Figure 4.1 – Module Bottom View – SD Card Slot

Note: The user will need to ensure that the SD Card has been formatted for FAT32.

Note: All files must be copied into the root directory of the SD Card. The module will not use files located in folders.

4.1 Firmware

The user can copy the required firmware (download at www.prosoft-technology.com) onto the root directory of the SD Card.

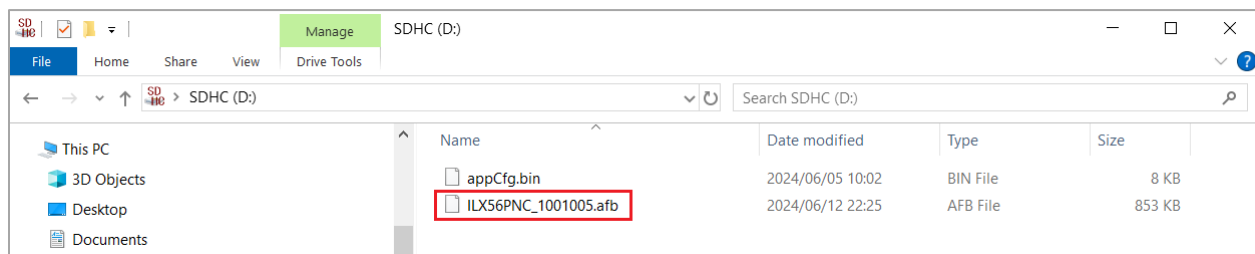

Figure 4.2 – SD Card – Firmware file

Note: The filename of the firmware file must not be changed. The specific module will use only the firmware that is valid (e.g. the ILX56-PNC will only use the PNC firmware file).

Note: If more than one firmware file with different firmware revisions of the same product is on the SD Card, it can cause the module to constantly firmware upgrade the module.

If a faulty module is replaced, the user can insert the SD Card with the firmware file into the new module. While the module is booting it can detect if the firmware on the replacement module is different from that on the SD Card. If yes, the firmware will either be upgraded or downgraded to the firmware revision on the SD Card.

4.2 Configuration

If a faulty module is replaced, the user can insert the SD Card with the configuration file into the new module. The new module will determine if the configuration on the SD Card is different than the currently loaded configuration (even when there is no configuration on the module). If different, the configuration on the SD Card will be downloaded into the module's NV memory before the module starts executing.

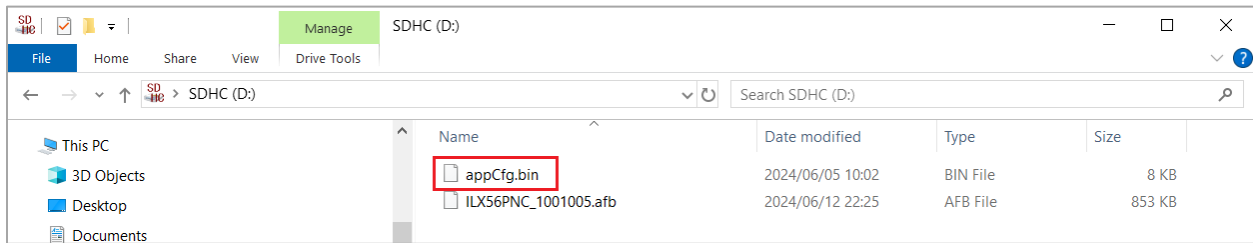

Figure 4.3 – SD Card – Configuration file

Once the user has created the necessary application configuration in the PLX50 Configuration Utility, the configuration can be exported to a file that can be used on the SD Card. The user can copy this exported file into the root directory of the SD Card.

4.2.1 Exporting the Configuration File

To export the configuration, right-click on the ILX56-PNC and select the **EXPORT CONFIGURATION FILE** option.

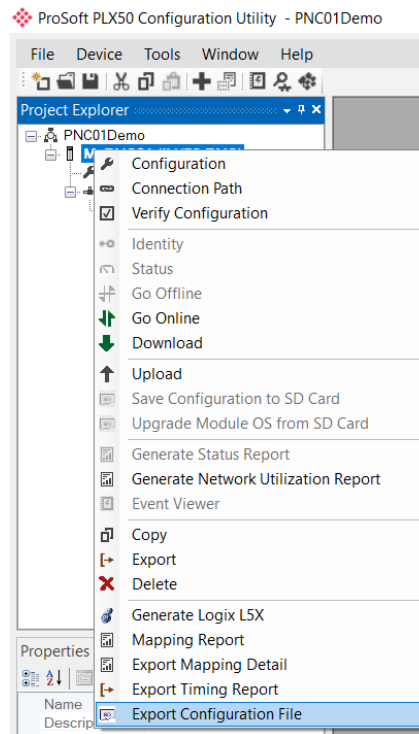

Figure 4.4 – Configuration Export for SD Card

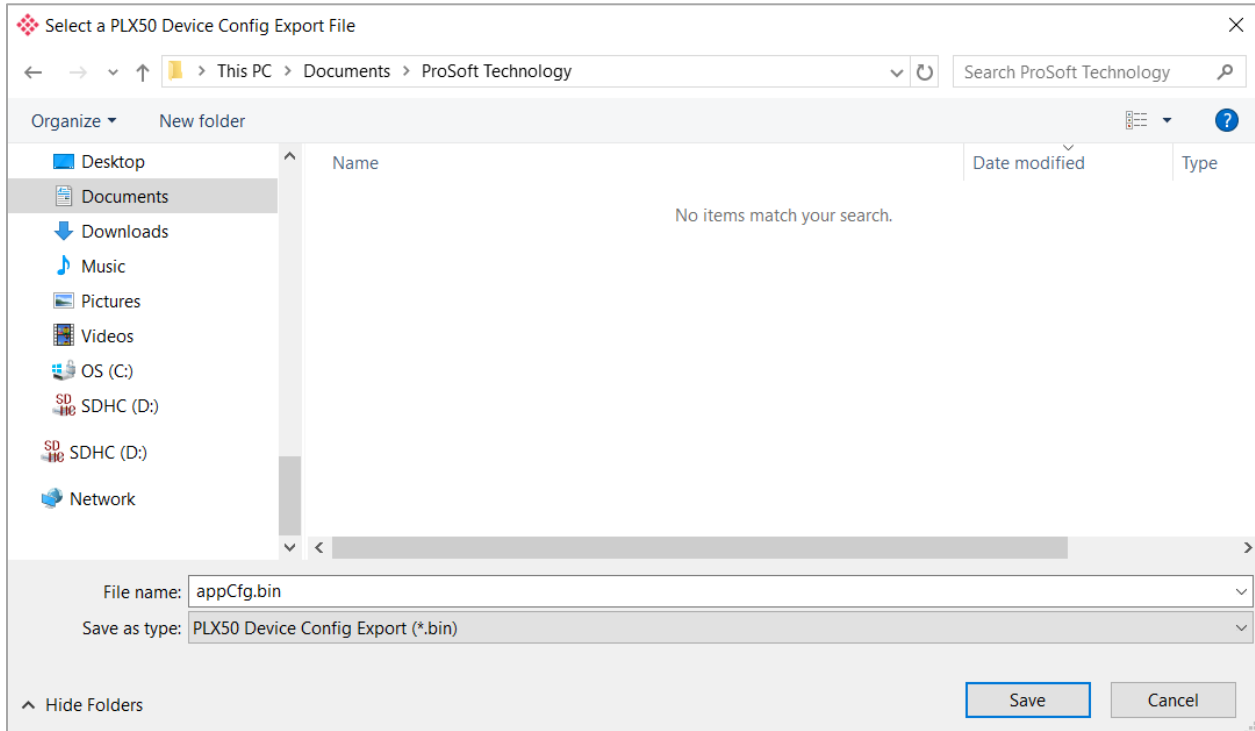

Figure 4.5 – Configuration Export for SD Card

Note: The filename of the configuration file must not be changed. The specific module will use only the configuration that is valid (e.g. the ILX56-PNC will only use the PNC configuration file).

Note: If more than one configuration file with different configuration signatures of the same product is on the SD Card, then only the last configuration will be used.

5 Operation

5.1 Logix Operation

When the ILX56-PNC has been configured for Logix communication, it will exchange data with a Logix controller by adding the ILX56-PNC in the IO tree and establishing a Class 1 connection. Once the ILX56-PNC and Logix controller have been configured, the ILX56-PNC will start exchanging data with the PROFINET devices.

Note: The module input and output assembly of each connection will be an undecorated array of bytes. The imported Logix routine (generated by PLX50 Configuration Utility) will copy this data between the decorated tags (UDT) and the input and output assemblies.

5.1.1 PNC Controller Status

The controller Status tag displays the status of the PROFINET Controller and other ILX56-PNC module related diagnostics.

Name	Value	Style	Data Type
Local:1:11		{...}	PS:ILX56_PNC_InStatus:I:0
Local:1:11.ConnectionFaulted		0 Decimal	BOOL
Local:1:11.ControllerStatus		0 Decimal	DINT
Local:1:11.ConfigValid		0 Decimal	BOOL
Local:1:11.Owned		0 Decimal	BOOL
Local:1:11.EthernetPort1		0 Decimal	BOOL
Local:1:11.EthernetPort2		0 Decimal	BOOL
Local:1:11.PROFINETNetworkError		0 Decimal	BOOL
Local:1:11.PROFINETDeviceError		0 Decimal	BOOL
Local:1:11.PROFINETOffline		0 Decimal	BOOL
Local:1:11.PROFINETIdle		0 Decimal	BOOL
Local:1:11.PROFINETStop		0 Decimal	BOOL
Local:1:11.PROFINETRun		0 Decimal	BOOL
Local:1:11.ControllerMode		0 Decimal	BOOL
Local:1:11.RedundancyEnabled		0 Decimal	BOOL
Local:1:11.ModuleRedundancyConfigMismatch		0 Decimal	BOOL
Local:1:11.SDCard		0 Decimal	BOOL
Local:1:11.ConfigCRC	16#0000	Hex	INT
Local:1:11.DeviceLiveList		{...}	PS_ILX56_PNC_DeviceList_S...
Local:1:11.DeviceDataExchangeActive		{...}	PS_ILX56_PNC_DeviceList_S...
Local:1:11.DeviceAlarmPendingFlags		{...}	PS_ILX56_PNC_DeviceList_S...
Local:1:11.ModuleIPAddress		{...} Decimal	INT[4]
Local:1:11.MRPState		0 Decimal	SINT

Figure 5.1 – Logix Controller Status tag

The items contained within the controller status structure are as follows:

Tag	Description
ConnectionFaulted	Indicates if a connection fault has been detected. 1 – Connection fault 0 – No connection fault
Module Status	Indicates the status of the module. It reflects the status on all Bool data types in the following Controller Tags.
ConfigValid	Configuration has been downloaded to the ILX56-PNC and is being executed. 1 – ILX56-PNC has been successfully configured. 0 – ILX56-PNC is not configured.
Owned	Indicates if the ILX56-PNC is owned by a Logix Controller with a connection count matching that configured in PLX50 Configuration Utility. 1 – ILX56-PNC is connected. 0 – ILX56-PNC is not connected.
EthernetPort1	Indicates the link status of the first Ethernet port (Port 0). 1 – Active Ethernet link 0 – No Ethernet link
EthernetPort2	Indicates the link status of the second Ethernet port (Port 1). 1 – Active Ethernet link 0 – No Ethernet link
PROFINETNetworkError	The PROFINET network is not operating correctly. 1 – No IO devices are exchanging data 0 – At least one IO device is exchanging data
PROFINETDeviceError	At least one IO device has a communication issue (e.g. offline, not exchanging process data, etc.) 1 – At least one IO device is not exchanging data 0 – All PN IO devices are exchanging data
PROFINETOffline	The PROFINET network is Offline and the ILX56-PNC will not communicate on the network. 1 – PROFINET state is OFFLINE. 0 – PROFINET state is not OFFLINE.
PROFINETIdle	The PROFINET network is running in Idle mode, the ILX56-PNC is communicating on the network, but it will not exchange any process data with IO devices. 1 – PROFINET state is IDLE. 0 – PROFINET state is not IDLE.
PROFINETStop	The PROFINET network is in Stop mode, and the ILX56-PNC is communicating with IO devices on the network, but with the data being sent from the ILX56-PNC flagged as non-valid. 1 – PROFINET state is STOPPED. 0 – PROFINET state is not STOPPED.
PROFINETRun	The PROFINET network is running, and the ILX56-PNC is communicating with IO devices on the network. 1 – PROFINET state is RUN. 0 – PROFINET state is not RUN.
ControllerMode	The connected Logix controller is in RUN mode. 1 – RUN mode 0 – PROGRAM / FAULT mode
RedundancyEnabled	Indicated the module has been configured for S2 Redundancy. 1 – S2 Redundancy Enabled 0 – S2 Redundancy Disabled (Standalone)
ModuleRedundancyConfigMismatch	Indicates that the two ILX56-PNC modules, (in an S2 Redundant pair) have differing configurations. 1 – Configurations do not match

	0 – Configurations match
<i>SDCard</i>	Indicates if an SD Card is installed. 1 – SD Card detected 0 – No SD Card
<i>ConfigCRC</i>	The signature of the configuration currently executing on the module.
<i>DeviceLiveList</i>	Indicates the devices that are online on the local PROFINET network. Each bit represents a device. When the specific bit is set '1' then the device is online and when the bit is off '0' the device is not on the PROFINET network. Bit 0 – Device Index 0 Online Bit 1 – Device Index 1 Online Bit 63 – Device Index 63 Online
<i>DeviceDataExchangeActive</i>	Indicates the devices that are online and exchanging cyclic data on the PROFINET network. Each bit represents a device. When the specific bit is set '1' then the device is online and exchanging data and when the bit is off '0' the device is not exchanging data. Bit 0 – Device Index 0 Exchanging Data Bit 1 – Device Index 1 Exchanging Data Bit 63 – Device Index 63 Exchanging Data
<i>DeviceAlarmPendingFlags</i>	Indicates the devices that have an alarm pending on the local PROFINET network. Each bit represents a device. When the specific bit is set '1' then the device has an alarm pending that must be unloaded and when the bit is off '0' the device does not have an alarm pending. Bit 0 – Device Index 0 Alarm Pending Bit 1 – Device Index 1 Alarm Pending Bit 63 – Device Index 63 Alarm Pending
<i>ModuleIPAddress</i>	Indicates the IP address of the ILX56-PNC controller.
<i>MRPState</i>	Indicates the MRP state of the controller: 0 – Disabled 1 – Open Ring 2 – Closed Ring

Table 5.1 – Logix Controller Status tag

5.1.2 PNC Control

The user will need to set the PROFINET Operating mode from the ILX56-PNC Logix output assembly in the Logix controller.

Name	Value	Style	Data Type
Local:1:O1		{...}	PS:ILX56_PNC_OutControl:O:0
▶ Local:1:O1.ControllerStateOverride		0 Decimal	INT
▶ Local:1:O1.PartnerConfigCRC		16#0000 Hex	INT
▶ Local:1:O1.DeviceDisable		{...}	PS_ILX56_PNC_DeviceList_Struct:IO:0
Local:1:O1.SystemTime	DT#1970-01-01-02:00:00.000_000(UTC+02:00)	Date/Time	LINT

Figure 5.2 – Logix Controller Control tag

Tag	Description
ControllerStateOverride	This tag is used to set the override the normal state of the PROFINET controller. 0 – Normal (No Override) 1 – Set PROFINET network state to IDLE 2 – Set PROFINET network state to STOP
PartnerConfigCRC	Used to transfer the configuration (CRC) checksum between the two ILX56-PNC controllers in a S2 Redundant pair. Note: This should be controlled by the dedicated RedundancyController AOI only.
DeviceDisable	These bits disable devices on the PROFINET network for data exchange. Each bit represents a device. When the specific bit is set '1' then the device will not enter data exchange and when the bit is off '0' the device will enter cyclic data exchange. Bit 0 – Device 0 is disabled for data exchange Bit 1 – Device 1 is disabled for data exchange Bit 63 – Device 63 is disabled for data exchange
SystemTime	The system time in UTC.

Table 5.2 – Logix Controller Control tag

The user will be able to see if there are any faults (e.g. configured device not found) by viewing the LEDs of the ILX56-PNC (see the *LEDs* section for more details), by going online with the module in the PLX50 Configuration Utility and viewing the ILX56-PNC Master and Device Diagnostics, or by viewing the input assembly of the ILX56-PNC in Logix.

5.1.3 Device Status and Input Data Exchange

The cyclic data is exchanged with Logix using the Class 1 Logix connection.

The device-specific (input) tag contains all device status and input data transferred from the device to the ILX56-PNC controller.

Name	Value	Style	Data Type	Description
- PNC01_IM1534PN	{ ... }		PNC01_002A03022996	
- PNC01_IM1534PN.PNInput	{ ... }		PNC01_002A03022996PNInput	
- PNC01_IM1534PN.PNInput.Status	{ ... }		PSILX56PNDeviceStatus	
- PNC01_IM1534PN.PNInput.Status.Online	0	Decimal	BOOL	Device Online (0=Offline, 1=Online)
- PNC01_IM1534PN.PNInput.Status.DataExchangeActive	0	Decimal	BOOL	Data Exchange Active (0=Inactive, 1=Active)
- PNC01_IM1534PN.PNInput.Status.IdentMismatch	0	Decimal	BOOL	Device Identity Mismatch (0=Ok, 1=Mismatch)
- PNC01_IM1534PN.PNInput.Status.DisabledByOutputAssembly	0	Decimal	BOOL	Disabled by Output (0=Enabled, 1=Disabled)
- PNC01_IM1534PN.PNInput.Status.DeviceError	0	Decimal	BOOL	Profibus Device Error (0=Ok, 1=Error)
- PNC01_IM1534PN.PNInput.Status.AlarmPending	0	Decimal	BOOL	Alarm Pending (0=Not Pending, 1=Pending)
- PNC01_IM1534PN.PNInput.Status.OutputAssemblyIPAddrMismatch	0	Decimal	BOOL	Station IP Address Mismatch (0=Ok, 1=Mismatch)
- PNC01_IM1534PN.PNInput.Status.MappingCRCMismatch	0	Decimal	BOOL	Mapping Checksum Mismatch (0=Ok, 1=Mismatch)
- PNC01_IM1534PN.PNInput.Status.PrimaryConnection	0	Decimal	BOOL	Primary Connection (0=S2 Standby, 1=Primary)
- PNC01_IM1534PN.PNInput.Status.DeviceIPAddrMismatch	0	Decimal	BOOL	Device IP Address Mismatch (0=Ok, 1=Mismatch)
- PNC01_IM1534PN.PNInput.Status.ParameterWriteFail	0	Decimal	BOOL	Parameter Write Fail (0=All Ok, 1=At least one failed)
- PNC01_IM1534PN.PNInput.Status.ModuleMismatch	0	Decimal	BOOL	Module Configuration Mismatch (0=Ok, 1=Mismatch)
+ PNC01_IM1534PN.PNInput.Status.IPAddress	{ ... }	Decimal	INT[4]	Device IP Address
+ PNC01_IM1534PN.PNInput.Status.DeviceMappingCRC	16#0000	Hex	INT	Mapping checksum
+ PNC01_IM1534PN.PNInput.Status.DeviceIndex	0	Decimal	SINT	Device Index

Figure 5.3 – Device Specific tag (Input)

Parameter	Description
Status	
Online	This bit indicates if the device is online on the PROFINET network. 1 – Device is online 0 – Device is not online
DataExchangeActive	This bit indicates if the device is configured and exchanging data on the PROFINET network. 1 – Device is active and exchanging data 0 – Device is not exchanging data The user must ensure that all application code making use of data from a device first checks that the <i>DataExchangeActive</i> bit is 1.
IdentMismatch	The device configured in the PLX50 Configuration Utility and the device at the configured IP address do not match. 1 – Online device Ident does not match configured device 0 – Online device and configured device ident match
DisabledByOutputAssembly	This bit indicates that the device has been Disabled for data exchange in the ILX56-PNC device disable control bits. 1 – Device has been disabled for data exchange 0 – Device has been enabled for data exchange
DeviceError	This bit indicates an error with the device. 1 – Device has an error. 0 – Device has no error. Note: This Error flag is transient and will clear once the error condition has been rectified.
AlarmPending	Indicates the device has an alarm pending on the local PROFINET network. When the specific bit is set '1' then the device has an alarm pending that must be unloaded and when the bit is off '0' the device does not have an alarm pending. 0 – The device has no alarm pending 1 – The device has an alarm pending

OutputAssemblyIPAddrMismatch	This bit indicates that there is a mismatch between the actual PROFINET device IP address and the expected Logix mapping IP address. 0 – IP address matches 1 – IP address mismatch
MappingCRCMismatch	If there is a mismatch in the mapping between Logix and the ILX56-PNC it can result in data appearing in the incorrect location which means the user can be sending incorrect data to a device which can have unpredicted results. 0 – The mapping for the output data is correct. 1 – There is a mapping mismatch in the output data.
PrimaryConnection	When using S2 Redundancy, both controllers will connect to the device. The first connection will be the “Primary” connection, and the second connection will be the “S2 Standby” connection. In the case of an output device, only the output data in the Primary connection will be used. 0 – Standby (S2) 1 – Primary
DeviceIPAddrMismatch	The configuration name and IP address for this device does not match the actual name and IP address on the PROFINET network. 0 – Ok (normal) 1 – Mismatch
ParameterWriteFail	One or more of the parameters written to the device prior to establishing the cyclic exchange failed. 0 – No failures (Ok) 1 – Parameter Write Fail
ModuleMismatch	One or more of the configured modules in the PROFINET device does not match the configuration or is missing. 0 – Modules Match (Ok) 1 – Mismatch
IPAddress	The configured IP address of the device.
DeviceMappingCRC	The checksum of the Mapping for the specific device.
DeviceIndex	The index reference number of the PROFINET device. This is used when looking at the Live List, DataExchange List, and Alarm List in the Master Status, as well as when doing the Alarm unloading.

Table 5.3 – Device Input tags

5.1.4 Device Control and Output Data Exchange

The device-specific (output) tag contains all device control and output data transferred from the ILX56-PNC controller to the device.

Name	Value	Style	Data Type	Description
[-] PNC01_IM1534PN	{...}		PNC01_002A03022996	
[+] PNC01_IM1534PN.PNInput	{...}		PNC01_002A03022996PNInput	
[-] PNC01_IM1534PN.PNOutput	{...}		PNC01_002A03022996PNOutput	
[-] PNC01_IM1534PN.PNOutput.Control	{...}		PSILX56PNDeviceControl	
[+] PNC01_IM1534PN.PNOutput.Control.IPAddress	{...}	Decimal	INT[4]	Device IP Address
[+] PNC01_IM1534PN.PNOutput.Control.DeviceMappingCRC	16#0000	Hex	INT	Mapping Checksum
[+] PNC01_IM1534PN.PNOutput.S02_Outputs	0	Decimal	SINT	
[+] PNC01_IM1534PN.PNOutput.S02O_IOPS	{...}		PSILX56PNIStatus	

Figure 5.4 –Device Specific tag (Output)

Parameter	Description
<i>Control</i>	
IPAddress	The device's IP address set by the Logix mapping code.
DeviceMappingCRC	The checksum of the mapping that was applied by the generated Logix code used to verify if the mapping being used is valid.

Table 5.4 – Device Output tags

5.1.5 IO Data Status (IOPS / IOCS)

Contained within the device's input and output configuration specific data will be a number of IOPS (Input Output Object Provider Status) and IOCS (Input Output Object Consumer Status) objects. There are typically one of these per device module.

The IOPS provides information on the status of the produced data.

The IOCS provides information on the status of the consumed data.

Exposing these items to the Logix application code allows not only the monitoring of the status of input data, but also allows the application to control the status of the data being sent to the output devices.

In a typical data exchange with an **output** device, as shown below, the controller sends the output data and the IOPS. The IOPS can be controlled by the application code, perhaps flagging the data as bad under certain conditions which in turn could cause the output device to a fail-safe condition. The application code can also monitor the IOCS for confirmation that the device received the latest data.

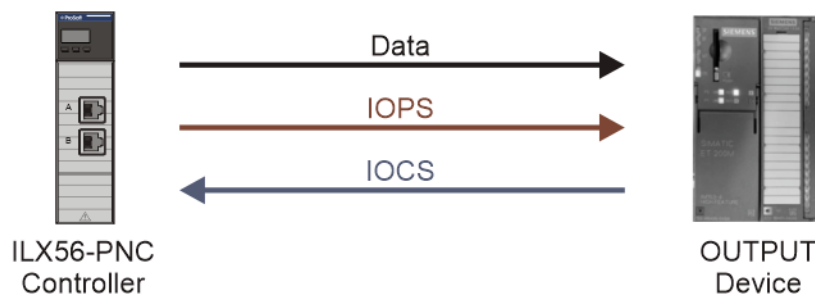

Figure 5.5 – Typical Output Device Data Exchange

In a typical data exchange with an **input** device, as shown below, the device sends the output data and the IOPS to the controller. The application code can use the IOPS to determine the quality of the data provide. Although the IOCS is returned from the controller to device, **this is taken care of automatically by the ILX56-PNC** and does therefore not appear in the mapping.

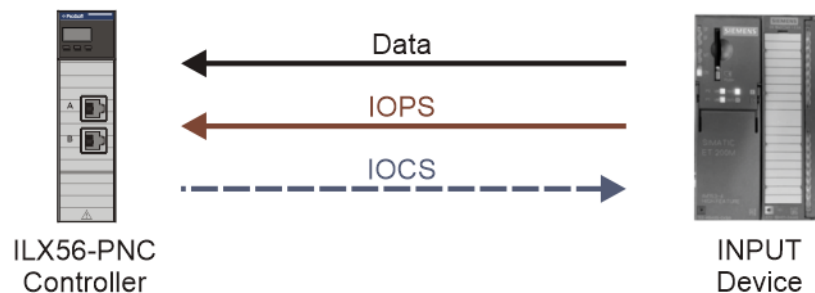

Figure 5.6 – Typical Input Device Data Exchange

Both the IOPS and IOCS are represented in the Logix structures using a common UDT structure, which expands the typically 1 byte status to a more Logix readable structure.

Name	Value	Style	Data Type	Description
[-] PNC01_IM1534PN.PNInput.S00_IOPS	{...}		PSILX56PNIOStatus	
[-] PNC01_IM1534PN.PNInput.S00_IOPS.DataBad	0	Decimal	BOOL	Data Bad
[-] PNC01_IM1534PN.PNInput.S00_IOPS.BadDetectedBySubslot	0	Decimal	BOOL	Bad Status Detected by SubSlot
[-] PNC01_IM1534PN.PNInput.S00_IOPS.BadDetectedBySlot	0	Decimal	BOOL	Bad Status Detected by Slot
[-] PNC01_IM1534PN.PNInput.S00_IOPS.BadDetectedByIODevice	0	Decimal	BOOL	Bad Status Detected by IO Device
[-] PNC01_IM1534PN.PNInput.S00_IOPS.BadDetectedByIOController	0	Decimal	BOOL	Bad Status Detected by Io Controller
[-] PNC01_IM1534PN.PNInput.S00_IOPS.AdditionalOctet	0	Decimal	BOOL	Additional Octet Available
[-] PNC01_IM1534PN.PNInput.S00_IOPS.NoModule	0	Decimal	BOOL	No Module
[-] PNC01_IM1534PN.PNInput.S00_IOPS.WrongModule	0	Decimal	BOOL	Wrong Module
[-] PNC01_IM1534PN.PNInput.S00_IOPS.ModuleSubstitute	0	Decimal	BOOL	Module Substitute
[-] PNC01_IM1534PN.PNInput.S00_IOPS.NoSubModule	0	Decimal	BOOL	No Submodule
[-] PNC01_IM1534PN.PNInput.S00_IOPS.WrongSubModule	0	Decimal	BOOL	Wrong Submodule
[-] PNC01_IM1534PN.PNInput.S00_IOPS.SubModuleSubstitute	0	Decimal	BOOL	Submodule Substitute
[+] PNC01_IM1534PN.PNInput.S00_IOPS.Octet1	0	Decimal	SINT	Additional IO Status Octet

Figure 5.7 – IO Data Status Specific tag

The IO Data Status structure comprises the following:

Parameter	Description
Status	
DataBad	Indicates the Data is bad. 0 – Data is good 1 – Data is bad
BadDetectedBySubslot	Indicates that the bad data is being flagged at the Subslot level.
BadDetectedBySlot	Indicates that the bad data is being flagged at the Slot level.
BadDetectedByIODevice	Indicates that the bad data is being flagged at the IO Device level.
BadDetectedByIOController	Indicates that the bad data is being flagged at the IO Controller level.
AdditionalOctet	Indicates that an additional octet is available.
NoModule	A missing module is detected.
WrongModule	An incorrect module is detected. (Different from the configuration.)
ModuleSubstitute	A substitute module is detected. (Different from the configuration, but sufficiently compatible to continue.)
NoSubModule	A missing submodule is detected.
WrongSubModule	An incorrect submodule is detected. (Different from the configuration.)
SubModuleSubstitute	A substitute submodule is detected. (Different from the configuration, but sufficiently compatible to continue.)
Additional Data	
Octet1	Additional status information

Table 5.5 – IO Data Status Specific tag

5.1.6 Device Alarm Unloading

The ILX56-PNC supports managing and unloading of PROFINET alarms generated by PROFINET devices. The ILX56-PNC can buffer up to 10 alarms per PROFINET device. The buffered alarms can be view in the PLX50 Configuration Utility Device Status page. See the *Alarms* section for more information regarding alarm viewing.

Note: The alarms viewed in PLX50 Configuration Utility is only viewing the buffered alarms that the ILX56-PNC has received from specific PROFINET devices. The alarms will not be unloaded when viewing as alarms are unloaded in Logix.

The *AlarmsPending* status bit in the Device Status (in Logix) can be used to determine if there are alarms that need to be unloaded from the ILX56-PNC module. Once this bit is set, the user can execute a Logix MSG instruction to unload the pending alarm. The *AlarmPending* status bit will be cleared once all buffered alarms have been unloaded.

Name	Value	Style	Data Type	Description
[-] PNC01_IM1534PN	{ ... }		PNC01_002A03022...	
[-] PNC01_IM1534PN.PNInput	{ ... }		PNC01_002A03022...	
[-] PNC01_IM1534PN.PNInput.Status	{ ... }		PSILX56PNDeviceS...	
[-] PNC01_IM1534PN.PNInput.Status.Online	0	Decimal	BOOL	Device Online (0=Offline, 1=Online)
[-] PNC01_IM1534PN.PNInput.Status.DataExchangeActive	0	Decimal	BOOL	Data Exchange Active (0=Inactive, 1=Active)
[-] PNC01_IM1534PN.PNInput.Status.IdentMismatch	0	Decimal	BOOL	Device Identity Mismatch (0=Ok, 1=Mismatch)
[-] PNC01_IM1534PN.PNInput.Status.DisabledByOutputAssembly	0	Decimal	BOOL	Disabled by Output (0=Enabled, 1=Disabled)
[-] PNC01_IM1534PN.PNInput.Status.DeviceError	0	Decimal	BOOL	Profibus Device Error (0=Ok, 1=Error)
[-] PNC01_IM1534PN.PNInput.Status.AlarmPending	0	Decimal	BOOL	Alarm Pending (0=Not Pending, 1=Pending)
[-] PNC01_IM1534PN.PNInput.Status.OutputAssemblyIPAddrMismatch	0	Decimal	BOOL	Station IP Address Mismatch (0=Ok, 1=Mismatch)
[-] PNC01_IM1534PN.PNInput.Status.MappingCRCMismatch	0	Decimal	BOOL	Mapping Checksum Mismatch (0=Ok, 1=Mismatch)
[-] PNC01_IM1534PN.PNInput.Status.PrimaryConnection	0	Decimal	BOOL	Primary Connection (0=S2 Standby, 1=Primary)
[-] PNC01_IM1534PN.PNInput.Status.DeviceIPAddrMismatch	0	Decimal	BOOL	Device IP Address Mismatch (0=Ok, 1=Mismatch)
[-] PNC01_IM1534PN.PNInput.Status.ParameterWriteFail	0	Decimal	BOOL	Parameter Write Fail (0=All Ok, 1=At least one failed)
[-] PNC01_IM1534PN.PNInput.Status.ModuleMismatch	0	Decimal	BOOL	Module Configuration Mismatch (0=Ok, 1=Mismatch)
[+] PNC01_IM1534PN.PNInput.Status.IPAddress	{ ... }	Decimal	INT[4]	Device IP Address
[+] PNC01_IM1534PN.PNInput.Status.DeviceMappingCRC	16#0000	Hex	INT	Mapping checksum
[+] PNC01_IM1534PN.PNInput.Status.DeviceIndex	0	Decimal	SINT	Device Index

Figure 5.8 – Alarm Pending Indicator

Note: When the user generates the L5X Logix import file from the PLX50 Configuration Utility, the UDT for alarm unloading will also be generated.

The screenshot shows a software window titled "Data Type: PSILX56PNDeviceAlarmRecord". The window contains the following information:

- Name:** PSILX56PNDeviceAlarmRecord
- Data Type Size:** 424 bytes
- Description:** (Empty field)
- Members:** A table listing the structure's members.

Name	Data Type	Description
AlarmCount	INT	Alarm Count
Reserved0	INT	Reserved
Reserved1	DINT	Reserved
AlarmIndex	INT	Alarm Index
PDUType	SINT	PDU Type
Reserved2	SINT	Reserved
AlarmDataLen	INT	Alarm Data Length
Reserved3	INT	Reserved
TimeStamp	LINT	Time Stamp
AlarmData	SINT[400]	Alarm Data

Figure 5.9 – Alarm Unload UDT Structure

5.1.6.1 CIP Message

Parameter	Description
Service Code	0x7E (Hex)
Class	0x501 (Hex)
Instance	1
Attribute	N/A
Request Data Length	2
Response Data Length	24 to 424

Table 5.6 – Alarm Unloading CIP Message

5.1.6.1.1 Request Data

Parameter	Data Type	Description
DeviceIndex	INT	The index of the PROFINET device from which the alarm must be unloaded.

Note: The Device Index is shown in the Device Status Tag in Logix.

Table 5.7 – Alarm Unloading CIP Message Request

5.1.6.1.2 Response Data

Parameter	Data Type	Description
AlarmCount	INT	Number of alarms in the payload. Currently this will always be 1.
AlarmIndex	INT	The index number of the alarm. Every time an alarm is buffered, the index count is increased and rolls over at 65535.
PduType	SINT	Packet type Bit 0 – 3: Type 1 – RTA DATA 2 – RTA NACK 3 – RTA ACK 4 – RTA ERROR Bit 4 – 7: Version Version 1 or Version 2 of the protocol.
AlarmDataLen	INT	The length of the Alarm Data
TimeStamp	LINT	The timestamp when the alarm occurred.
AlarmData	SINT[]	Alarm Data

Table 5.8 – Alarm Unloading CIP Message Response

5.1.7 Explicit Acyclic Messaging

The ILX56-PNC supports explicit acyclic messaging to PROFINET devices via either, unconnected messaging (UCMM) or Class 3 connected messaging. The ILX56-PNC can buffer up to 10 acyclic messages at a time. The details of the message are as follows:

5.1.7.1 CIP Message

Parameter	Description
Service Code	0x75 (Hex)
Class	0x501 (Hex)
Instance	1
Attribute	N/A
Request Data Length	28 to 500
Response Data Length	6 to 500

Table 5.9 – Explicit Acyclic CIP Message

5.1.7.1.1 Request Data

Parameter	Data Type	Description
IPAddress	INT[4]	The IP address of the target device.
Function	SINT	The function to be performed. 0 – Read 1 – Write 2 – Read Implicit
Reserved	SINT[3]	Reserved
VendorID	INT	The Vendor ID of the target device. Required only for Read Implicit.
DeviceID	INT	The Device ID of the target device. Required only for Read Implicit.
API	DINT	The target API for the message. (Typically, 0).
Slot	INT	The target Slot number.
SubSlot	INT	The target Subslot number. Set to 0 for communication to a Slot.
Index	INT	The target parameter Index.
DataLength	INT	For Write functions: The length of the following request data. For Read & Read Implicit functions: The maximum length of the response data.
Data	SINT[]	Request Data.

Table 5.10 – Explicit Acyclic CIP Message Request

5.1.7.1.2 Response Data

Parameter	Data Type	Description
Status	DINT	The returned status of the acyclic request. Byte 0: Error Code Byte 1: Error Decode Byte 2: Error Code 1 Byte 3: Error Code 2 Note: See the Appendix for information regarding the error codes.
Data Length	INT	The length of the data returned.
Data	SINT[]	The data from the Read / Read Implicit request. The number of bytes will be equal to the Data Length in the response.

Table 5.11 – Explicit Acyclic CIP Message Response

Note: The Explicit Acyclic Request and Response UDTs are automatically included in the L5X export (Generate Logix L5X), and are named as follows:

PSILX56PNDeviceAcyclicMsgRequest

PSILX56PNDeviceAcyclicMsgResponse

5.2 Acyclic Messaging Utility

The PLX50 Configuration Utility provides a utility to initiate explicit acyclic messages to a PROFINET device via the ILX56-PNC. The messaging Actions are *Read*, *Write*, or *Read Implicit*. To open this utility, right-click on a PROFINET device and select the **ACYCLIC MESSAGING** option.

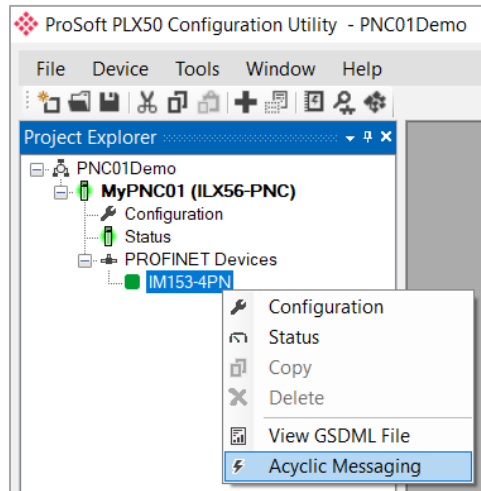

Figure 5.10 – Acyclic Messaging Option

Use the *Action* drop-down to select the type of explicit message. Depending on the type selected, various other parameter controls will become available. Once the parameters have been entered, click the **EXECUTE** button to initiate the explicit exchange.

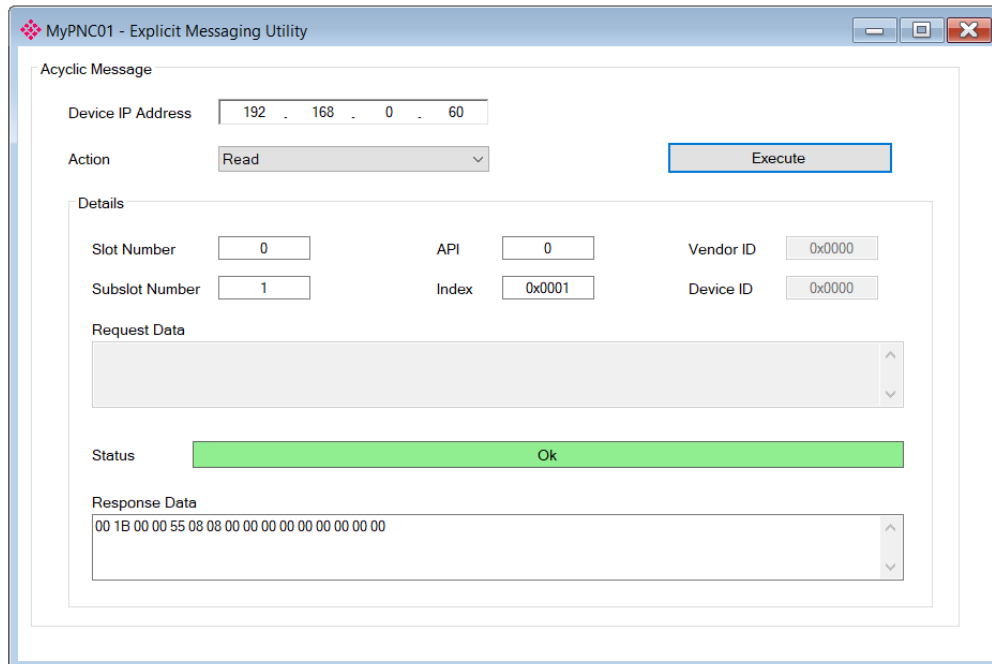

Figure 5.11 – Acyclic Messaging example

6 Firmware Upgrade

The ILX56-PNC allows the user to upgrade the module firmware in the field by using the PLX50 Configuration Utility.

In the PLX50 Configuration Utility go to the *Tools* menu and select the **DEVICEFLASH** option.

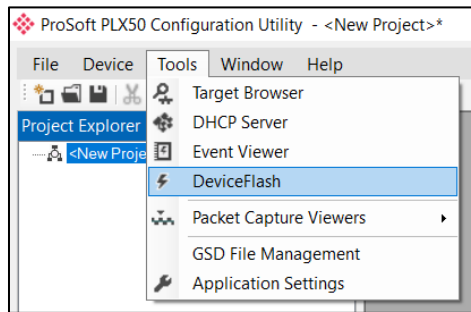

Figure 6.1 - DeviceFlash Tool

The user will need to select the appropriate AFB binary file to upgrade the ILX56-PNC firmware then click **OPEN**.

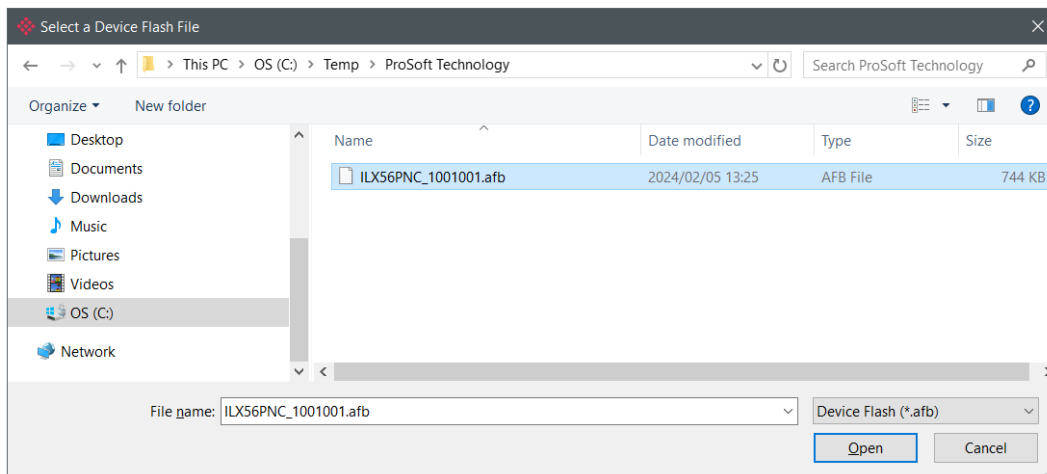

Figure 6.2 - Select the AFB binary

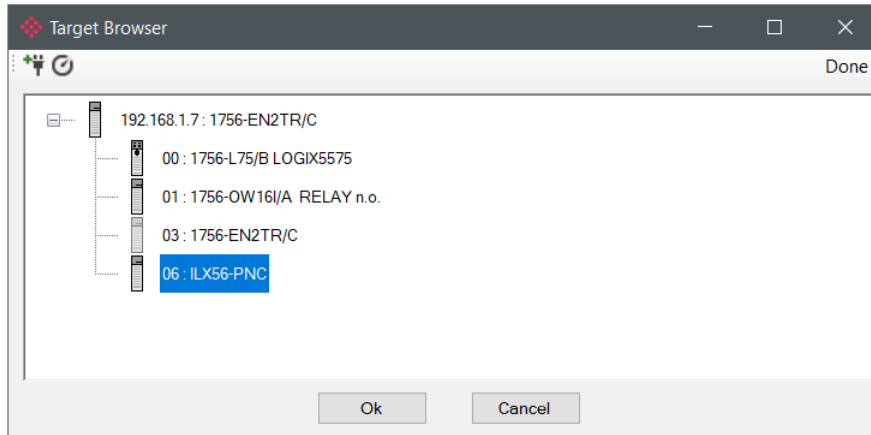

Figure 6.3 - Select the correct ILX56-PNC module

Once the firmware upgrade is complete, the *Device Flash* dialog will provide the user with the details of the updated module.

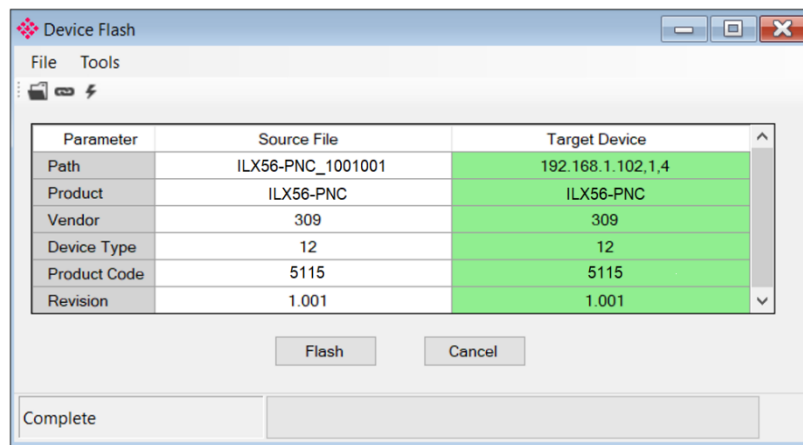

Figure 6.4 – ILX56-PNC successfully updated.

Note: The ILX56-PNC firmware is digitally signed so the user will only be able to flash the ILX56-PNC with authorized firmware.

Note: After the firmware upgrade process is complete, the module must be power cycled.

7 Media Redundancy Protocol (MRP)

Media Redundancy Protocol (MRP) allows PROFINET devices to be connected in an Ethernet ring topology which provides protection against single-cable-fault communication failures.

An MRP ring consists of multiple MRP clients and a single MRP manager. The manager monitors the integrity of the ring by sending Test Frames out one port and expects them to appear on the other port. When the ring is healthy the manager blocks all traffic transfer between its ports.

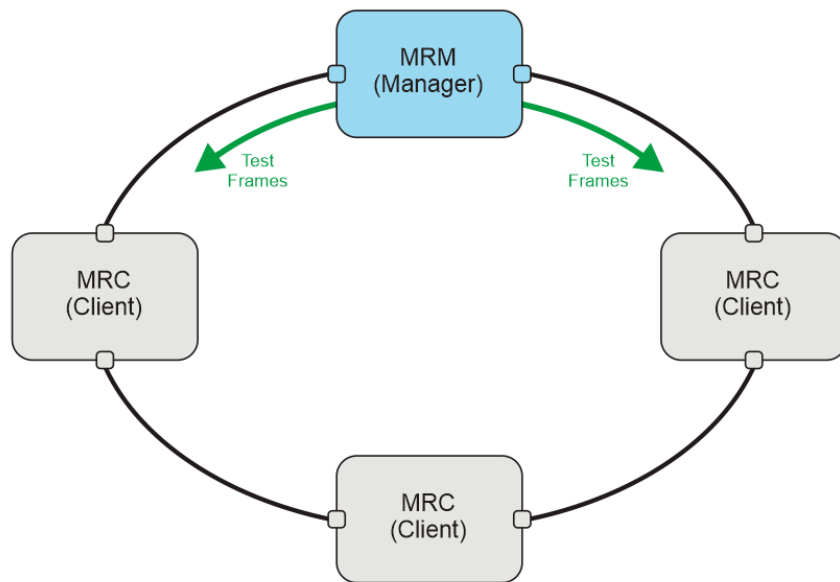

Figure 7.1 – MRP Ring

If the ring is broken (due to a cable failure or disconnection) then the MRP manager has to notify the other client devices in the ring that there is a failure and then switch its own ports to a line topology, that is, passing packets between its own ports.

This process typically takes a few milliseconds, without the cyclic data exchange between the controller and devices being adversely affected.

7.1 Basic Rules

All devices in a ring must comply with the following:

- 1) All devices must support MRP and have MRP enabled.
- 2) One device must be configured as an MRP Manager (MRM), and all the other devices must be configured as MRP Clients (MRC).
- 3) All devices must be configured with the same MRP Domain.
- 4) Devices must be connected to the ring using their two configured ring ports.
- 5) All partner ports must have the same configuration.

Note: When commissioning an MRP ring ensure that all devices have been correctly configured before closing the ring. Failure to do so may cause a complete network failure and prevent further configuration of some, or all, of the devices.

Note: The IO Update Time and WatchDog Factor for each device must be configured such that the MRP fault recovery will not result in the cyclic connection timing out.

Note: When changing which device is the MRP Manager, there may be a time when there is no configured MRP Manager. An unconfigured MRP Manager can cause an uncontrolled Ethernet ring that will create a network disturbance. The ring must first be broken by disconnecting one of the Ethernet ports, and only reconnected once the configuration process is complete.

8 S2 Redundancy

The ILX56-PNC module supports PROFINET S2 Redundancy. This strategy makes use of a pair of identically configured ILX56-PNC controllers active on the same PROFINET network.

For a PROFINET device to participate in the S2 Redundancy strategy, its NAP (Network Access Point) must be capable of supporting multiple connections. In S2 Redundancy, both ILX56-PNC controllers establish connections to the PROFINET device. The first controller to connect will be given a Primary connection status, while the second controller to connect will be given a Standby (S2) connection status. Both connections transfer valid input data from the device to the controller.

Only the output data in the Primary connection is used by the device, the output data in the Standby connection is ignored. Should the Primary connection be interrupted for any reason, then the Standby connection will be upgraded to Primary status.

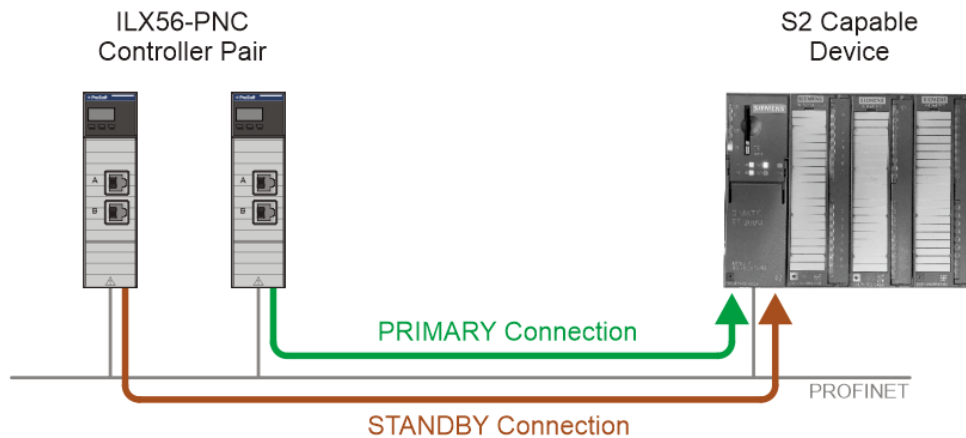

Figure 8.1 – S2 Redundancy

Note: It is possible to mix S2 capable and non-capable devices on the same PROFINET network. However, no redundant functionality will be afforded to the non-S2-capable devices.

8.1 Configuration

The ILX56-PNC configuration for S2 Redundancy is similar to that of the Standalone with the following important differences.

8.1.1 Controller Configuration - General

In the *General* tab of the ILX56-PNC *Configuration* dialog, the *Mode* must be set to **CONTROLLER S2 REDUNDANCY**.

The *Base Tag B* parameter must be configured to reflect the correct chassis and slot number.

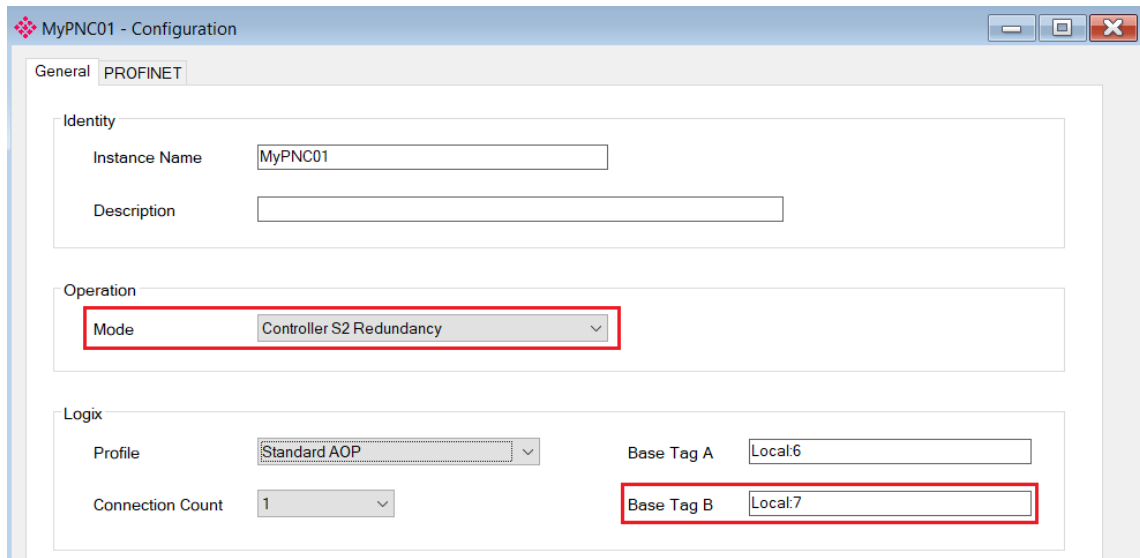

Figure 8.2 – S2 Redundancy – General configuration

In the *PROFINET* tab, the IP Address of the second ILX56-PNC must be configured in *IP Address B*.

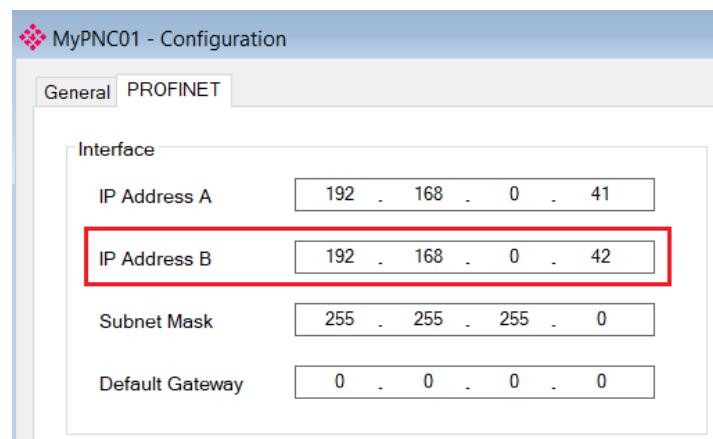

Figure 8.3 – S2 Redundancy – PROFINET configuration

8.1.2 Device Configuration

For each device participating in S2 Redundancy, the **ENABLE S2 REDUNDANCY** option must be selected in the *PROFINET* tab.

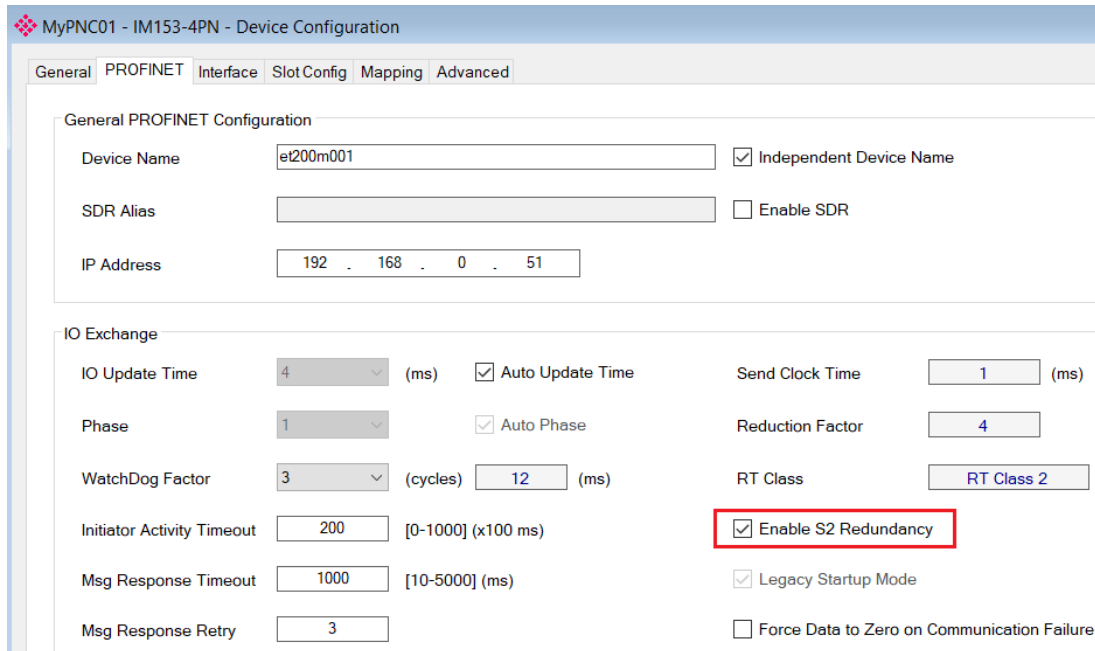

Figure 8.4 – S2 Redundancy – Device configuration

8.1.3 Module Download

Before the configuration can be downloaded to both ILX56-PNC modules, the connection paths must be configured.

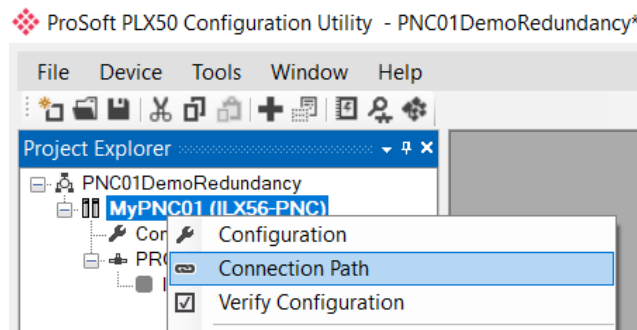

Figure 8.5 – S2 Redundancy – Select Connection Path

The connection paths can be either entered manually, or by using the Target Browser.

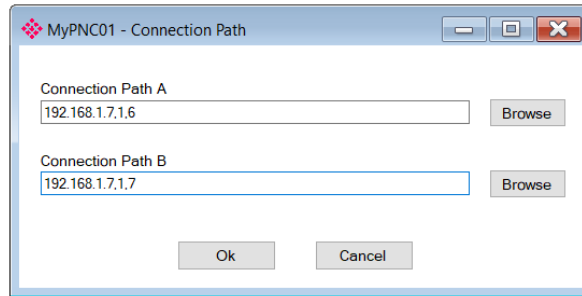

Figure 8.6 – S2 Redundancy – Connection Paths

When selecting the **DOWNLOAD** option, the configuration will be downloaded to both ILX56-PNC modules.

8.1.4 Logix Configuration

The Logix configuration in Studio 5000 requires both the ILX56-PNC modules to be instantiated. It is important that the *Instance Names* match that of the *Instance Name* provided in the PLX50 Configuration Utility, with an “A” and “B” suffix.

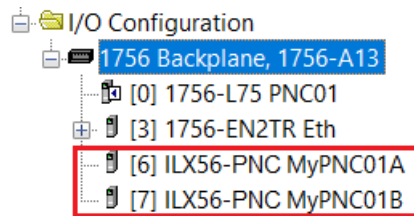

Figure 8.7 – S2 Redundancy – Logix IO Configuration

In the PLX50 Configuration Utility, select the **GENERATE LOGIX L5X** option to generate the required mapping code. This L5X file can then be imported into the Studio 5000 project. Although the mapping code is similar to that generated in a Standalone mode system, there are some differences, particularly for the S2 Redundant devices.

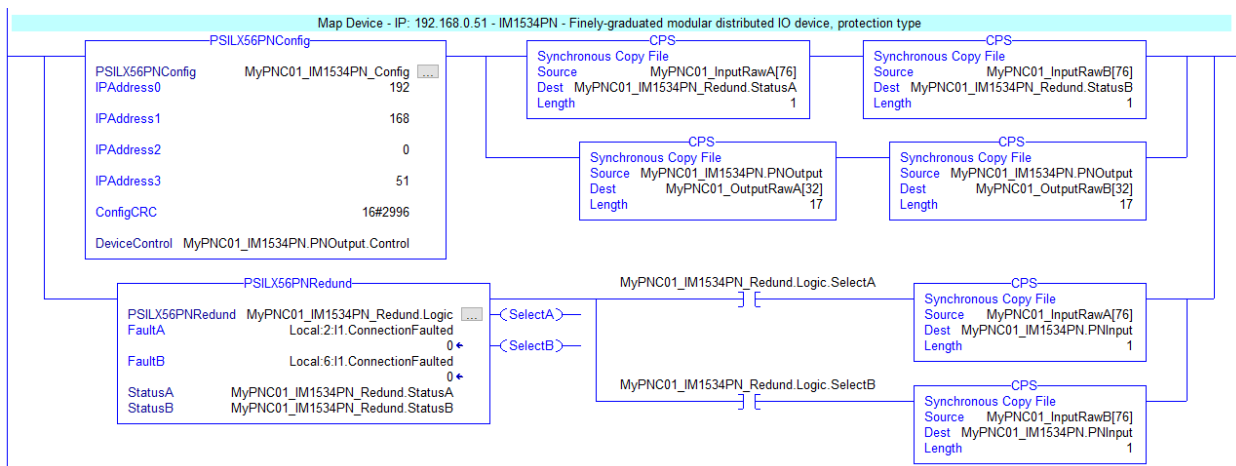

Figure 8.8 – S2 Redundancy – Example Device mapping

9 Diagnostics

9.1 LEDs

The module provides 3 diagnostic LEDs and a 4-character alpha-numeric LED display for diagnostics purposes as shown in the front view figure below.

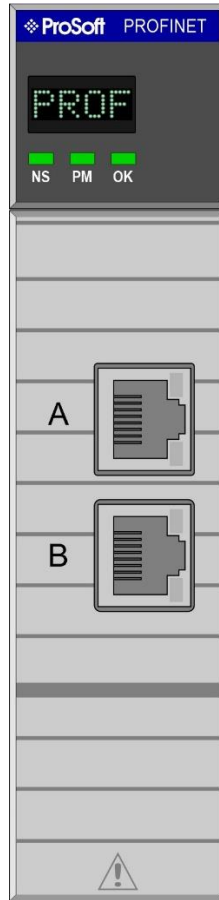

Figure 9.1 - ILX56-PNC LEDs

A description of each LED is given in the table below.

LED	Description
Ok	The module LED will provide information regarding the system-level operation of the module. Flashing Red – The module is not operating correctly. For example, if the module application firmware has been corrupted or there is a hardware fault the module will have a red Module LED. Flashing Green – The module has booted and is running correctly without any application configuration loaded. Solid Green – The module has booted and is running correctly with application configuration loaded.
PM	This LED will indicate the PROFINET operating state. Flashing Red – The PROFINET network is in IDLE mode. Flashing Green – The PROFINET network is in STOP mode. Solid Green – The PROFINET network is in RUN mode. Solid Red – The PROFINET network is OFFLINE, because the module has not been configured.
NS	This LED indicates the status of the PROFINET network. Off – No communication on the PROFINET network. Solid Red – There are network communication errors (none of the configured devices are online). Flashing Red – No devices are exchanging data due to device errors or devices being disabled. Flashing Green – Some devices are exchanging data on the PROFINET network. Solid Green – There are no network communication or device errors (NOTE: if no devices have been configured, then the NS LED will also be solid green).

Table 9.1 - Module LED operation

A description of each alphanumeric display message is given in the table below.

LED Text	Description
<i>TEST</i>	The module is busy testing all hardware during bootup.
<i>OK</i>	The module has successfully booted, and all hardware testing has passed.
<i>Stop Mode</i>	The PROFINET network is in STOP operational mode.
<i>Run Mode</i>	The PROFINET network is in RUN operational mode.
<i>Idle Mode</i>	The PROFINET network is in IDLE operational mode.
<i>Offline Mode</i>	The PROFINET network is in OFFLINE operational mode.
<i>IP x.x.x.x</i>	The IP address of the local ILX56-PNC module.
<i>Devices in Error</i>	Certain devices on the PROFINET network are in an error state.
<i>Devices not Exchanging Data</i>	All the configured devices on the PROFINET network are exchanging data with the PROFINET controller.
<i>No Devices Online</i>	None of the configured PROFINET devices are online on the PROFINET network.
<i>Redundant Controller</i>	The local ILX56-PNC is part of a redundant PROFINET Master pair.
<i>No Config Loaded</i>	No configuration has been loaded onto the ILX56-PNC.

Table 9.2 - Module LED operation

The module LED will also display the instance name of the module configured in PLX50 Configuration Utility.

9.1 Module Status Monitoring

The ILX56-PNC provides a range of statistics that assists with module operation, maintenance, and fault finding. The statistics can be accessed in full by the PLX50 Configuration Utility.

To view the module's status in the PLX50 Configuration Utility environment, the ILX56-PNC must be online. If the module is not already Online (following a recent configuration download), then right-click on the module and select the **GO ONLINE** option.

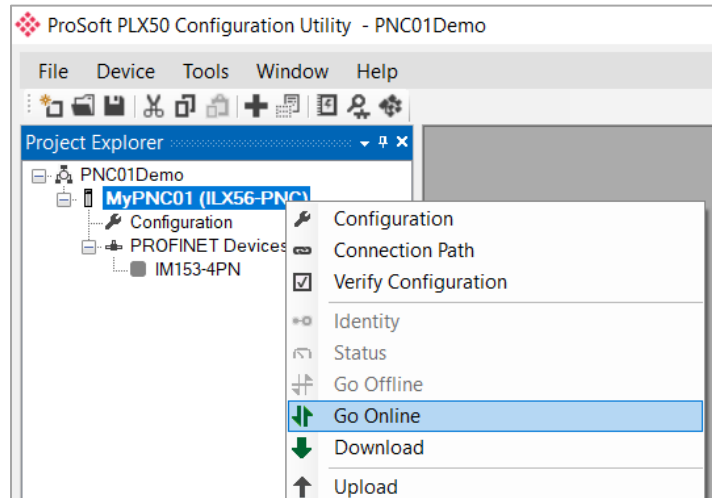

Figure 9.2 - Selecting to Go Online

The Online mode is indicated by the green circle behind the module in the Project Explorer tree.

9.1.1 ILX56-PNC

The Status monitoring window can be opened by either double-clicking on the *Status* item in the Project Explorer tree, or by right-clicking on the module and selecting **STATUS**.

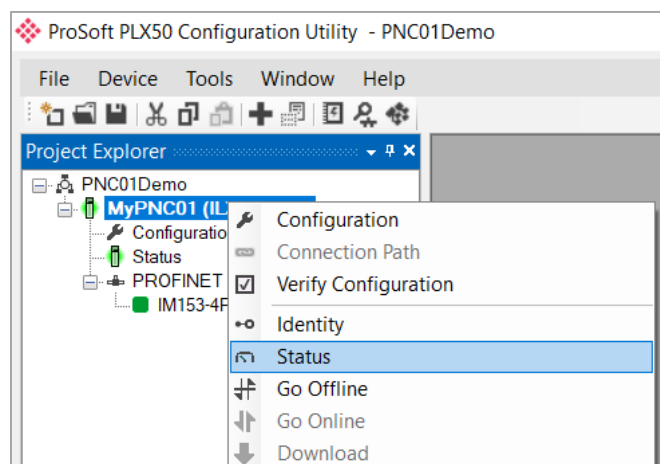

Figure 9.3 - Selecting ILX56-PNC Online Status monitoring

The status window contains multiple tabs to display the current status of the module.

9.1.1.1 General

The *General* tab displays the following general parameters:

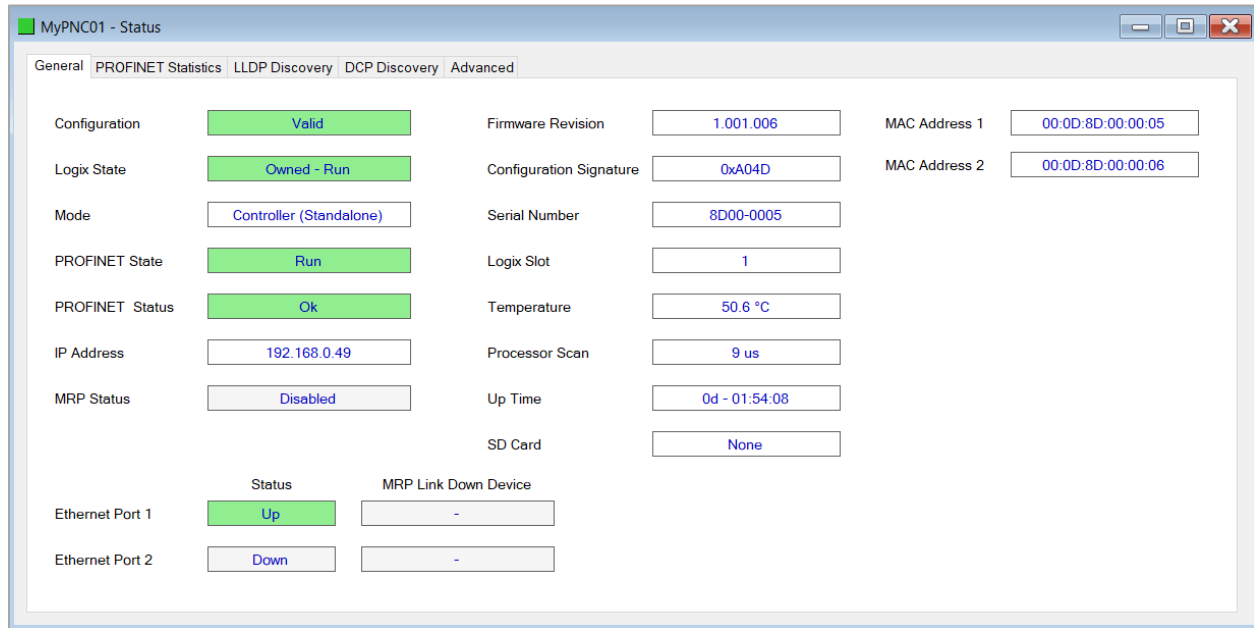

Figure 9.4 – ILX56-PNC Status monitoring - General

Parameter	Description
Configuration	Indicates if the downloaded configuration is valid and executing. Valid – Configuration is valid. Not Valid – Configuration is blank or corrupt.
Logix State	Indicates if the module is currently owned (Class 1) by a Logix controller and the state of the controller: Not Owned – Logic controller not connected. Owned - Run – Controller is connected and in RUN mode Owned Program – Controller is connected and in PROGRAM, FAULT, or TEST mode.
Mode	This is the mode of operation of the module. The following states can be returned: Controller (Standalone) – In this mode the ILX56-PNC is the standalone controller on the PROFINET network. Controller S2 Redundancy – In this mode a pair of ILX56-PNC modules both act as controllers on the PROFINET network. See the section on <i>S2 Redundancy</i> for more information.

PROFINET State	<p>This is the operational state of the PROFINET network. The following states can be returned:</p> <p>Offline – The PROFINET network is offline, and the ILX56-PNC will not communicate on the network.</p> <p>Idle – The PROFINET network is running in Idle mode, the ILX56-PNC is communicating on the network, but it will not exchange any process data with IO devices.</p> <p>Stop – The PROFINET network is in Stop mode, and the ILX56-PNC is communicating with IO devices on the network, but with the data being sent from the ILX56-PNC flagged as non-valid.</p> <p>Run – The PROFINET network is running, and the ILX56-PNC is communicating with IO devices on the network.</p>
PROFINET Status	<p>Status of the PROFINET network:</p> <p>Ok – No PROFINET errors.</p> <p>Network Error – PROFINET network issue detected.</p> <p>Device Error – One or more PROFINET devices not communicating.</p>
IP Address	The IP address of the ILX56-PNC.
MRP Status	<p>The current MRP status:</p> <p>Disabled – MRP is disabled.</p> <p>Open Ring – The MRP ring is open.</p> <p>Closed Ring – The MRP ring is closed.</p>
Firmware Revision	The application firmware revision currently executing.
Configuration Signature	The signature of the configuration currently executing on the module.
Serial Number	Displays the module's serial number.
Logix Slot	The current slot in which the module resides of the ControlLogix rack.
Temperature	The internal temperature of the module.
Processor Scan	The amount of time (microseconds) taken by the module's processor in the last scan.
Up Time	Indicates the elapsed time since the module was powered-up.
SD Card	Indicates if a SD Card has been inserted into the module.
MAC Address 1 & 2	The MAC Addresses assigned to the PROFINET interface.
<i>Ethernet Ports 1 & 2</i>	
Status	<p>The current link status of the Ethernet port:</p> <p>Up – Port has an active Ethernet link.</p> <p>Down – Port has no Ethernet link.</p>
MRP Link Down Device	<p>The suspected device at which the MRP ring has been broken.</p> <p>Only applicable when MRP is enabled.</p>

Table 9.3 - Parameters displayed in the Status Monitoring – General Tab

9.1.1.2 PROFINET Statistics

The *PROFINET Statistics* tab displays the following general parameters:

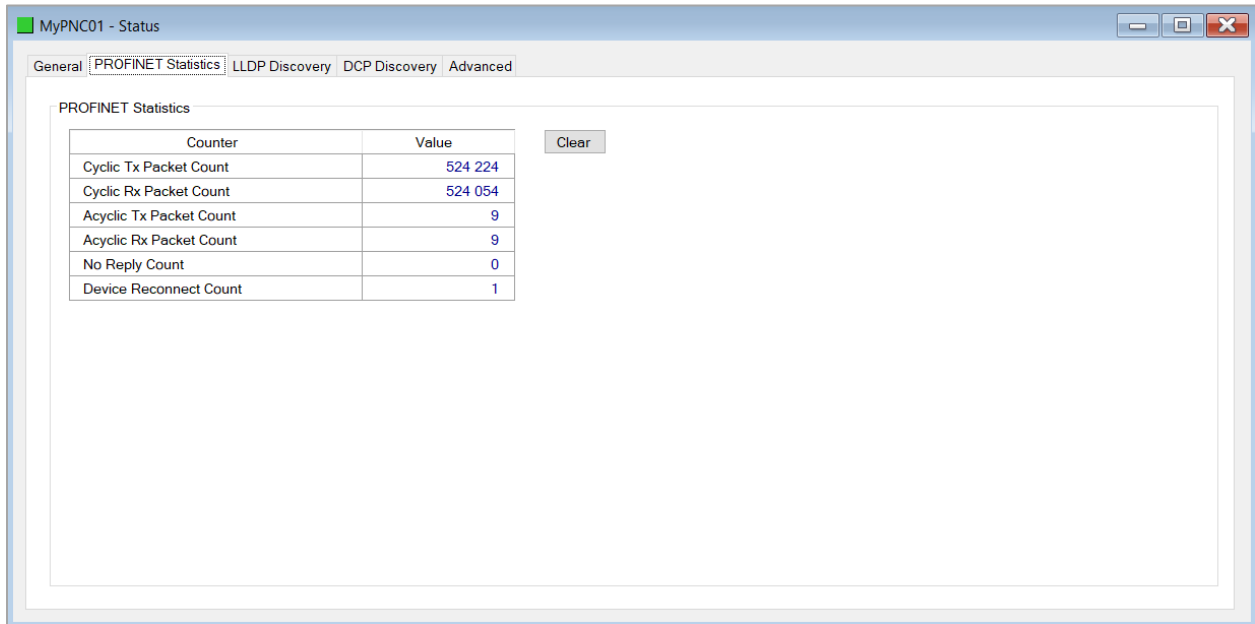

Figure 9.5 – ILX56-PNC Status monitoring – PROFINET Statistics

Parameter	Description
Cyclic Tx Packet Count	The number of cyclic PROFINET packets transmitted.
Cyclic Rx Packet Count	The number of cyclic PROFINET packets received.
Acyclic Tx Packet Count	The number of acyclic PROFINET packets transmitted.
Acyclic Rx Packet Count	The number of acyclic PROFINET packets received.
No Reply Count	The number of ILX56-PNC PROFINET requests where the device did not respond.
Device Reconnect Count	The number of device connection requests sent.

Table 9.4 - Parameters displayed in the Status Monitoring – General Statistics Tab

9.1.1.3 LLDP Discovery

The *LLDP Discovery* tab displays a list of all the devices on the network discovered using LLDP (Link Layer Discovery Protocol).

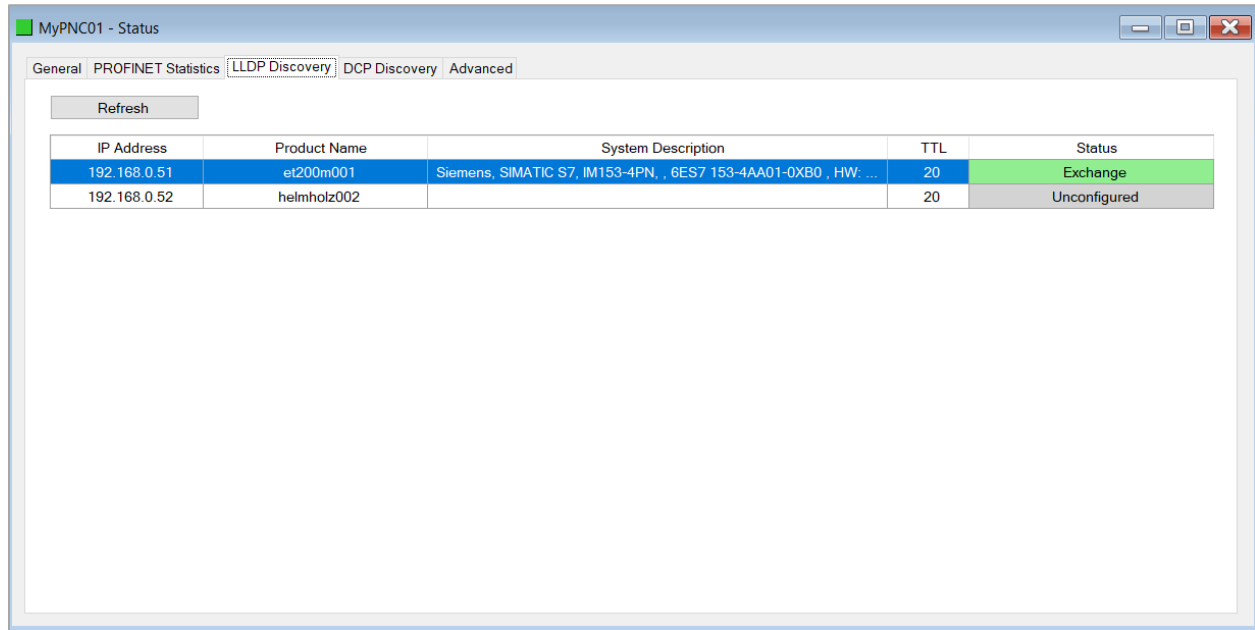

Figure 9.6 – ILX56-PNC Status monitoring – LLDP Discovery

The LLDP Discovery list will display the following for each device:

Parameter	Description
IP Address	The device's IP address.
Product Name	The device's reported Product Name.
System Description	The device's reported System Description.
TTL	The device's reported Time-To-Live. The amount of time, or hops, before a packet is deemed to be stale and is discarded.
Status	The PROFINET controller's connection status to the device.

Unconfigured – The device is not in the controller's configuration.
Configured – The device is configured but not online.
Online – No Data – The device is online but is not exchanging data.
Exchange – The device is online and exchanging data.
IP Configured – Name Mismatch – There exists a device in the configuration with this IP address, but it has a different Device Name.
Name configured, IP Address Mismatch – There exists a device in the configuration with this Device Name, but it has a different IP Address.

Table 9.5 - Parameters displayed in the Status Monitoring – LLDP Discovery

9.1.1.4 DCP Discovery

The *DCP Discovery* tab displays a list of all devices on the network discovered using DCP (Discovery and Configuration Protocol). To refresh the *DCP Discovery* list, click the **REFRESH DISCOVERY** button.

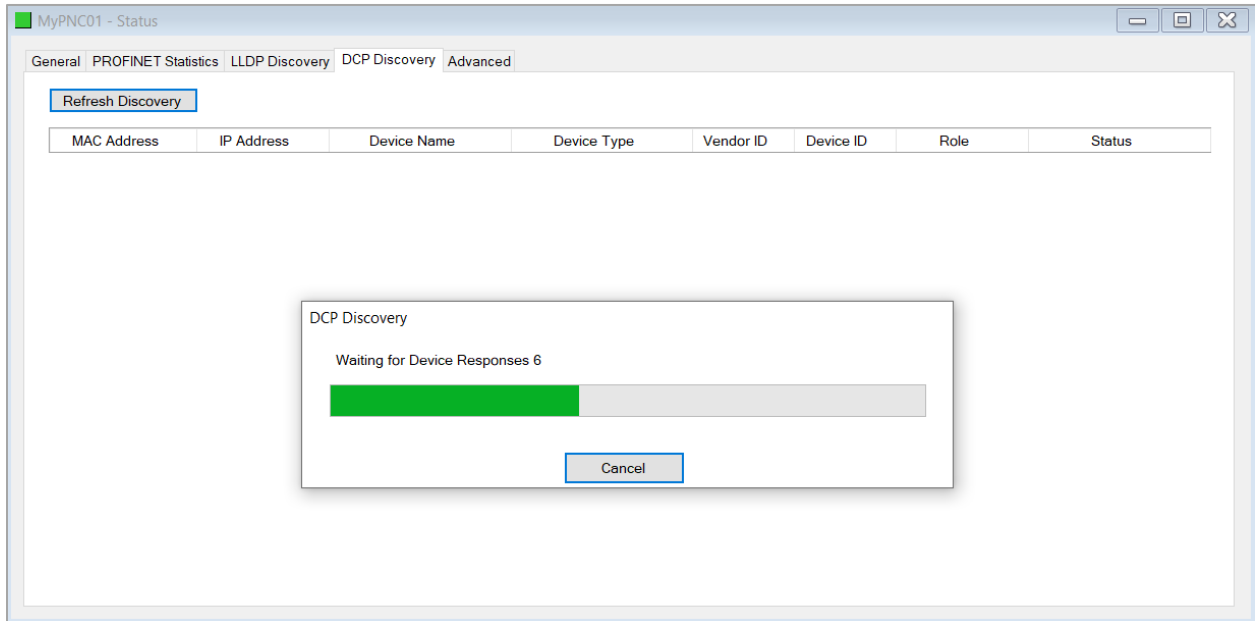

Figure 9.7 – ILX56-PNC Status monitoring – Refresh DCP Discovery

After a few seconds, the DCP Discovery list will be displayed.

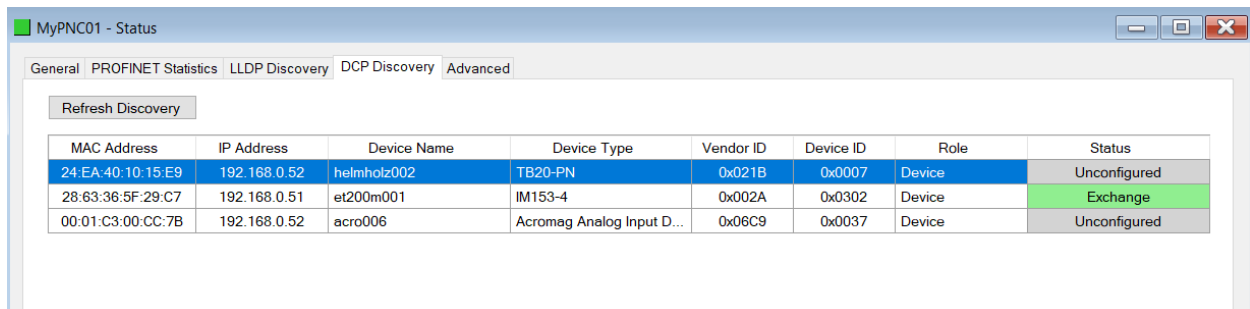

Figure 9.8 – ILX56-PNC Status monitoring – DCP Discovery

The DCP Discovery list will display the following for each device:

Parameter	Description
MAC Address	The device's MAC address.
IP Address	The device's IP address.
Device Name	The device's reported Device Name.
Device Type	The device's reported Device Type.
Vendor ID	The device's reported PROFINET Vendor ID.
Device ID	The device's reported PROFINET Device ID.
Role	The device's role: Device Controller Supervisor
Status	The PROFINET controller's connection status to the device. Unconfigured – The device is not in the controller's configuration. Configured – The device is configured but not online. Online – No Data – The device is online but is not exchanging data. Exchange – The device is online and exchanging data. IP Configured – Name Mismatch – There exists a device in the configuration with this IP address, but it has a different Device Name. Name configured, IP Address Mismatch – There exists a device in the configuration with this Device Name, but it has a different IP Address.

Table 9.6 - Parameters displayed in the Status Monitoring – DCP Discovery

9.1.1.5 Advanced

The *Advanced* tab displays various internal and low-level, diagnostics of the ILX56-PNC.

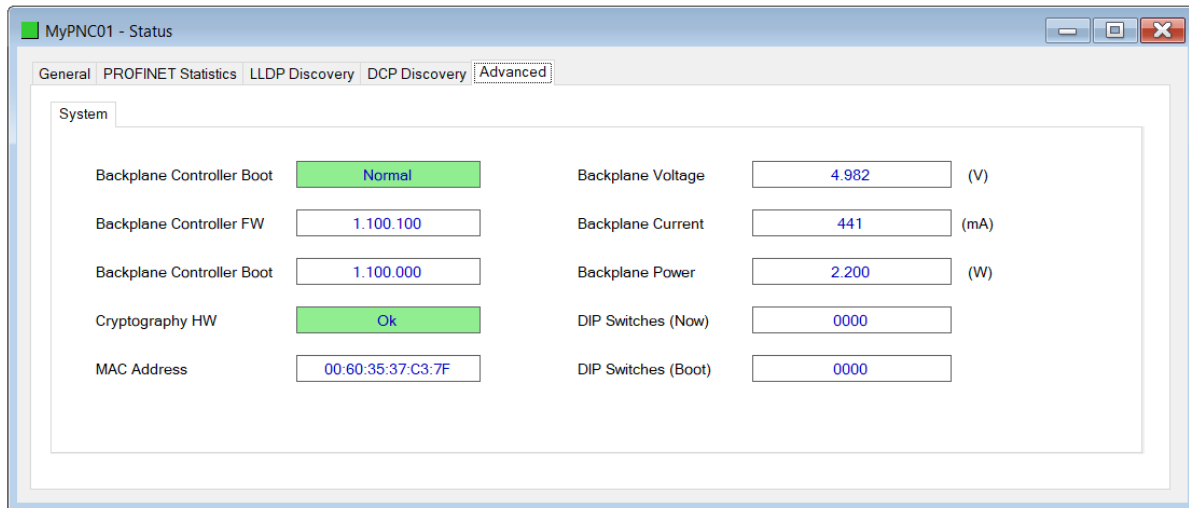

Figure 9.9 – ILX56-PNC Status monitoring – Advanced Tab

Parameter	Description
Backplane Controller Boot	The boot-up status of the backplane controller.
Backplane Controller FW	The firmware revision of the backplane controller.
Backplane Controller Boot	The bootloader version of the backplane controller.
Cryptography HW	The communication status to the cryptography processor.
MAC Address	The primary module MAC address.
Backplane Voltage	The measured backplane voltage.
Backplane Current	The measure backplane current in mA.
Backplane Power	The calculated backplane power consumption in W.
DIP Switch (Now)	The current status of the DIP switches.
DIP Switch (Boot)	The status of the DIP switches at Boot-up.

Table 9.7 - Parameters displayed in the Status Monitoring – Advanced Tab

9.1.2 Device Status

The Status monitoring window of each PROFINET device connected to the ILX56-PNC can be opened by right-clicking on the specific device in the PLX50 Configuration Utility project tree and selecting the **STATUS** option.

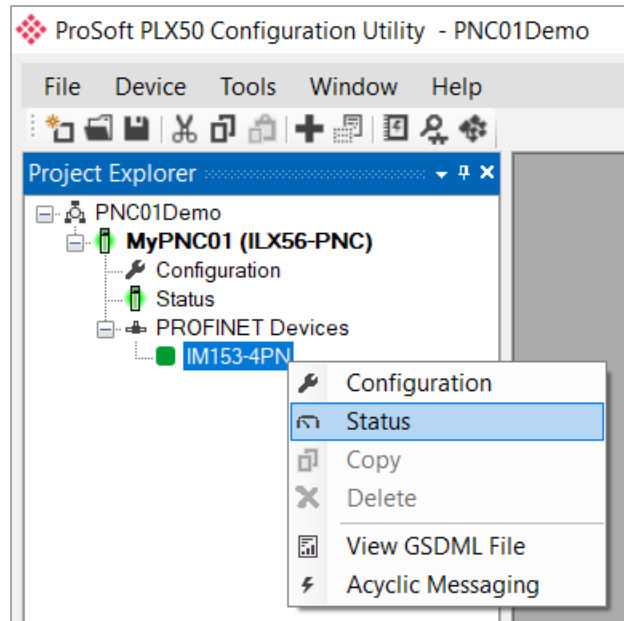

Figure 9.10 - Selecting device online Status

The device status window contains multiple tabs to display the current status of the selected device.

9.1.2.1 General

The *General* tab displays the following general parameters:

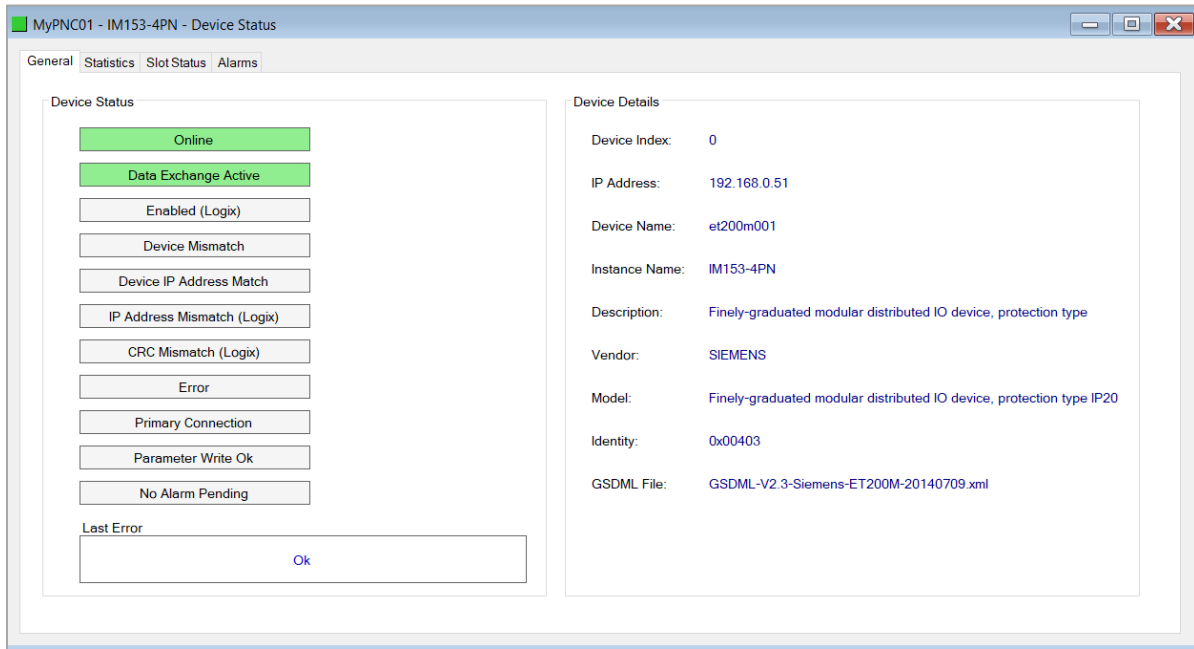

Figure 9.11 – Device Status monitoring - General

Parameter	Description
Device Status	The current status of the device: Online – The device is online. Offline – The device is offline. Data Exchange Active – The device is exchanging cyclic data with the ILX56-PNC. Data Exchange Inactive – The device is not exchanging cyclic data with the ILX56-PNC. Disabled (Logix) – The device has been disabled for cyclic data exchange by the Logix controller using the ILX56-PNC output assembly. Enabled (Logix) – The device has been enabled for cyclic data exchange by the Logix controller using the ILX56-PNC output assembly. Device GSDML Mismatch – The device configured in the PLX50 Configuration Utility and the device online at the specific IP address do not match. Device GSDML Match – The device configured in the PLX50 Configuration Utility matches the device online at the specific IP address. IP Address Mismatch (Logix) – The IP address entered from the Logix controller using the ILX56-PNC output assembly does not match the IP Address of the configured device. IP Address Match (Logix) – The IP address entered from the Logix controller using the ILX56-PNC output assembly matches the IP Address of the configured device.

CRC Mismatch (Logix) – Indicates the mapping from the Logix controller does not match the configured mapping in the ILX56-PNC.

CRC Match (Logix) – Indicates the mapping from the Logix controller matches the configured mapping in the ILX56-PNC.

Error – Device Error flag, which can be one of the following:

- The device connection was closed
- Device rejected the Parameter End command
- One or more of the received device's IOPS or IOCS is bad.
- There is a slot / sub-slot mismatch

No Error – No Device Error.

Primary Connection – The device is connected with a Primary connection.

Standby Connection – The device is connected with a Standby (S2) connection. Normal when using S2 Redundancy.

Parameter Write Ok – All the parameters written to the device prior to establishing the cyclic exchange were successful.

Parameter Write Fail – One or more of the parameters written to the device prior to establishing the cyclic exchange failed.

The description of the Error will be displayed in the Last Error text box.

Alarm Pending – Indicates the device has an alarm pending on the local PROFINET network.

No Alarm Pending – Indicates the device does not have an alarm pending on the local PROFINET network.

Last Error – Displays the last received connection error or parameter write error.

IP Address	The configured IP address for the device.
Device Name	The PROFINET Device Name.
Instance Name	The configured instance name for the device.
Description	The description of the device from the GSDML file.
Vendor	The Vendor of the device from the GSDML file.
Model	The Model name of the device from the GSDML file.
Identity	The Identity of the device from the GSDML file.
GSDML File	The GSDML file used for the configuration.

Table 9.8 - Device Status Monitoring – General Tab

9.1.2.2 Statistics

The *Statistics* tab displays the following general parameters:

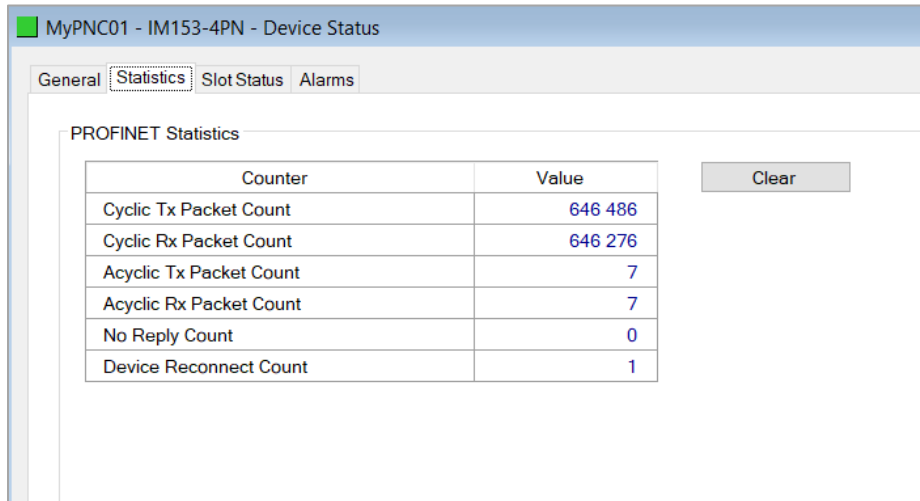

Figure 9.12 – Device Status monitoring – Statistics

Parameter	Description
Cyclic Tx Packet Count	The number of cyclic PROFINET packets transmitted to this device.
Cyclic Rx Packet Count	The number of cyclic PROFINET packets received from this device.
Acyclic Tx Packet Count	The number of acyclic PROFINET packets transmitted to this device.
Acyclic Rx Packet Count	The number of acyclic PROFINET packets received from this device.
No Reply Count	The number of ILX56-PNC PROFINET requests where this device did not respond.
Device Reconnect Count	The number of device connection requests sent to this device.

Table 9.9 - Device Status Monitoring – Statistics tab

9.1.2.3 Slot Status

The *Slot Status* tab displays the following parameters:

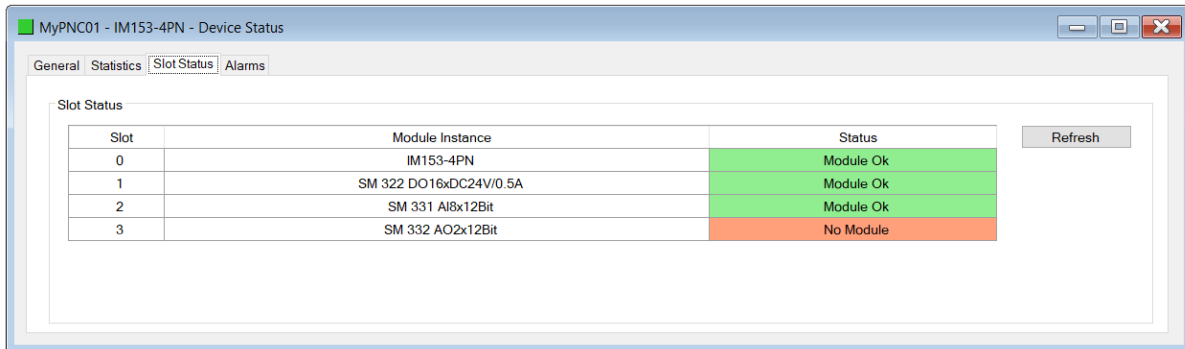

Figure 9.13 – Device Status Monitoring – Slot Status

Parameter	Description
Slot	The slot number and subslot number if applicable.
Module Instance	The instance name of the module configured for that slot.
Status	The status reported by the device for that slot: No Module – No module is detected in that slot. (Different from the configuration.) Wrong Module – An incorrect module is detected in that slot. (Different from the configuration.) Module Substitute – A substitute module is detected in that slot. Different from the configuration, but sufficiently compatible to continue. No Submodule – No submodule is detected in that subslot. (Different from the configuration.) Wrong Submodule – An incorrect submodule is detected in that subslot. (Different from the configuration.) Submodule Substitute – A substitute submodule is detected. Different from the configuration, but sufficiently compatible to continue.

Table 9.10 - Device Status Monitoring – Slot Status Parameters

9.1.2.4 Alarms

The *Alarms* tab displays the following parameters:

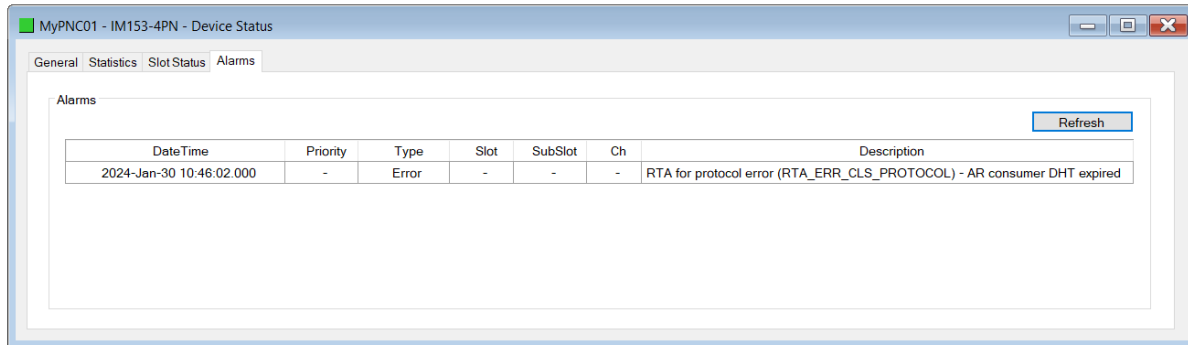

Figure 9.14 – Device Status monitoring – Alarms

Parameter	Description
DateTime	The Date and Time when the alarm occurred.
Priority	Will indicate the priority of the alarm. An alarm can have a high or low priority.
Type	The type of alarm that has occurred (e.g., pull or plug alarm, or process alarm, etc.).
Slot	The slot that generated the alarm.
Subslot	The sub-slot that generated the alarm.
Ch	The channel that generated the alarm.
Description	A description of what type of alarm has occurred.

Table 9.11 - Device Status Monitoring – Alarm Parameters

Note: The alarms viewed in PLX50 Configuration Utility is only viewing the buffered alarms that the ILX56-PNC has received from specific PROFINET devices. The alarms will not be unloaded when viewing as alarms are unloaded in Logix.

9.2 Module Event Log

The ILX56-PNC module logs various diagnostic records to an internal event log. These logs are stored in non-volatile memory and can be displayed using the PLX50 Configuration Utility. To view them in the PLX50 Configuration Utility, select the **EVENT VIEWER** option.

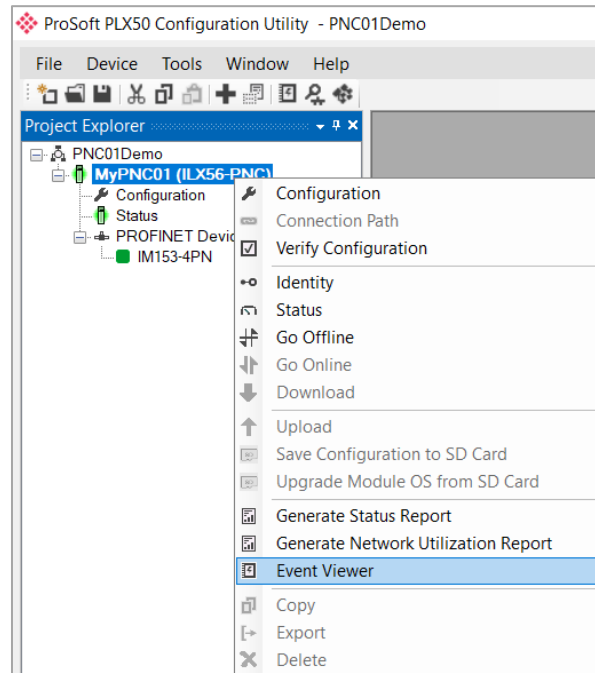

Figure 9.15. - Selecting the module Event Log

The *Event Viewer* window will open and automatically read all the events from the module. The log entries are sorted with the latest record at the top. Custom sorting is achieved by double-clicking on the column headings.

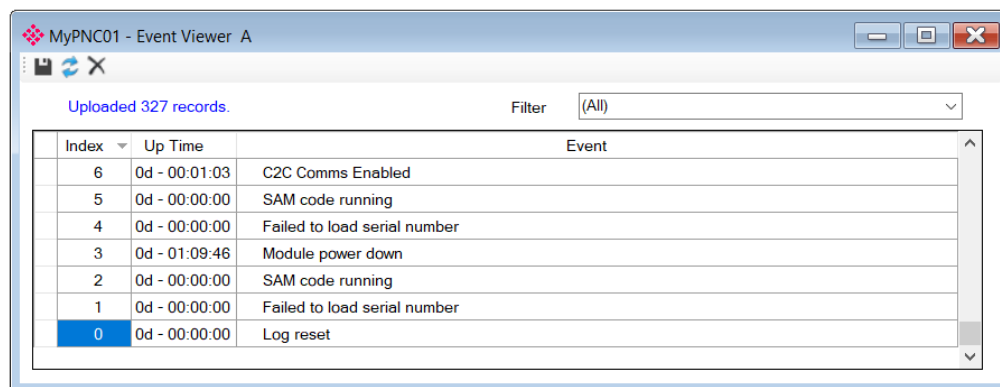

Figure 9.16. – Module Event Log

The log can also be stored to a file for future analysis, by clicking the **SAVE** button in the tool menu. To view previously saved files, use the *Event Log Viewer* option under the *Tools* menu.

10 Technical Specifications

10.1 Electrical

Specification	Description
Backplane Current Load	600 mA @ 5 VDC 2 mA @ 24 VDC
Enclosure rating	IP20, NEMA/UL Open Type
Temperature	0°C to 60°C (32°F to 140°F) ILX56-PNC-CC: -25°C to 70°C (-13°F to 158°F)
Earth connection	Yes, terminal based
Emissions	IEC61000-6-4
ESD Immunity	EN 61000-4-2
Radiated RF Immunity	IEC 61000-4-3
EFT/B Immunity	EFT: IEC 61000-4-4
Surge Immunity	Surge: IEC 61000-4-5
Conducted RF Immunity	IEC 61000-4-6

Table 10.1 - Electrical specification

10.2 PROFINET

Specification	Description
PROFINET Controller	Supported
Maximum PROFINET device count (Real Time comms)	64
DCP functions supported	Network Scan PROFINET name assign PROFINET IP address assign Device LED flash (for location) Device Reset
Media Redundancy Protocol (MRP)	Client Supported Manager Supported
PROFINET Conformance Level	B
S2 Redundancy	Supported
Device Alarm Management	Supported

Table 10.2 - PROFINET specification

10.3 ControlLogix

Specification	Description
Class 1 Connections	Maximum 11 x Class 1 connections supported.
Minimum Requested Packet Interval (RPI)	2ms for connection count <= 4. 10ms for connection count > 4.
UCMM Acyclic Messaging	Supported
Class 3 Acyclic Messaging	Supported

Table 10.3 - ControlLogix specification

10.4 Certifications

Please visit our website: www.prosoft-technology.com

11 Appendix

11.1 PROFINET Response Error Codes

The response status consists of four error codes:

- *ErrorCode*
- *ErrorDecode*
- *ErrorCode1*
- *ErrorCode2*

The definition of *ErrorCode1* and *ErrorCode2* will depend on the values of *ErrorCode* and *ErrorDecode*.

Note: There are many error code definitions, this section will only provide details relevant to Explicit Acyclic Messaging.

Error Code	Error Decode	Error Code 1	Error Code 2	Group	Error
0x81	0x80	0xA0	-	PNIO	Application - Read Error
0x81	0x80	0xA1	-	PNIO	Application - Write Error
0x81	0x80	0xA2	-	PNIO	Application - Module Failure
0x81	0x80	0xA7	-	PNIO	Application - Busy
0x81	0x80	0xA8	-	PNIO	Application - Version Conflict
0x81	0x80	0xA9	-	PNIO	Application - Feature Not Supported
0x81	0x80	0xB0	-	PNIO	Access - Invalid Index
0x81	0x80	0xB1	-	PNIO	Access - Write Length Error
0x81	0x80	0xB2	-	PNIO	Access - Invalid Slot / Subslot
0x81	0x80	0xB3	-	PNIO	Access - Type Conflict
0x81	0x80	0xB4	-	PNIO	Access - Invalid Area / API
0x81	0x80	0xB5	-	PNIO	Access - State Conflict
0x81	0x80	0xB6	-	PNIO	Access - Access Denied
0x81	0x80	0xB7	-	PNIO	Access - Invalid Range
0x81	0x80	0xB8	-	PNIO	Access - Invalid Parameter
0x81	0x80	0xB9	-	PNIO	Access - Invalid Type
0x81	0x80	0xBA	-	PNIO	Access - Backup
0x81	0x80	0xC0	-	PNIO	Resource - Read Constraint Conflict
0x81	0x80	0xC1	-	PNIO	Resource - Write Constraint Conflict
0x81	0x80	0xC2	-	PNIO	Resource - Resource Busy
0x81	0x80	0xC3	-	PNIO	Resource - Resource Unavailable
0xDE	0x80	0xA0	-	IOD Read	Application - Read Error
0xDE	0x80	0xA1	-	IOD Read	Application - Write Error

Error Code	Error Decode	Error Code 1	Error Code 2	Group	Error
0xDE	0x80	0xA2	-	IOD Read	Application - Module Failure
0xDE	0x80	0xA7	-	IOD Read	Application - Busy
0xDE	0x80	0xA8	-	IOD Read	Application - Version Conflict
0xDE	0x80	0xA9	-	IOD Read	Application - Feature Not Supported
0xDE	0x80	0xB0	-	IOD Read	Access - Invalid Index
0xDE	0x80	0xB1	-	IOD Read	Access - Write Length Error
0xDE	0x80	0xB2	-	IOD Read	Access - Invalid Slot / Subslot
0xDE	0x80	0xB3	-	IOD Read	Access - Type Conflict
0xDE	0x80	0xB4	-	IOD Read	Access - Invalid Area / API
0xDE	0x80	0xB5	-	IOD Read	Access - State Conflict
0xDE	0x80	0xB6	-	IOD Read	Access - Access Denied
0xDE	0x80	0xB7	-	IOD Read	Access - Invalid Range
0xDE	0x80	0xB8	-	IOD Read	Access - Invalid Parameter
0xDE	0x80	0xB9	-	IOD Read	Access - Invalid Type
0xDE	0x80	0xBA	-	IOD Read	Access - Backup
0xDE	0x80	0xC0	-	IOD Read	Resource - Read Constraint Conflict
0xDE	0x80	0xC1	-	IOD Read	Resource - Write Constraint Conflict
0xDE	0x80	0xC2	-	IOD Read	Resource - Resource Busy
0xDE	0x80	0xC3	-	IOD Read	Resource - Resource Unavailable
0xDF	0x80	0xA0	-	IOD Write	Application - Read Error
0xDF	0x80	0xA1	-	IOD Write	Application - Write Error
0xDF	0x80	0xA2	-	IOD Write	Application - Module Failure
0xDF	0x80	0xA7	-	IOD Write	Application - Busy
0xDF	0x80	0xA8	-	IOD Write	Application - Version Conflict
0xDF	0x80	0xA9	-	IOD Write	Application - Feature Not Supported
0xDF	0x80	0xB0	-	IOD Write	Access - Invalid Index
0xDF	0x80	0xB1	-	IOD Write	Access - Write Length Error
0xDF	0x80	0xB2	-	IOD Write	Access - Invalid Slot / Subslot
0xDF	0x80	0xB3	-	IOD Write	Access - Type Conflict
0xDF	0x80	0xB4	-	IOD Write	Access - Invalid Area / API
0xDF	0x80	0xB5	-	IOD Write	Access - State Conflict
0xDF	0x80	0xB6	-	IOD Write	Access - Access Denied
0xDF	0x80	0xB7	-	IOD Write	Access - Invalid Range
0xDF	0x80	0xB8	-	IOD Write	Access - Invalid Parameter
0xDF	0x80	0xB9	-	IOD Write	Access - Invalid Type
0xDF	0x80	0xBA	-	IOD Write	Access - Backup
0xDF	0x80	0xC0	-	IOD Write	Resource - Read Constraint Conflict
0xDF	0x80	0xC1	-	IOD Write	Resource - Write Constraint Conflict
0xDF	0x80	0xC2	-	IOD Write	Resource - Resource Busy
0xDF	0x80	0xC3	-	IOD Write	Resource - Resource Unavailable

Table 11.1 - Error Response codes

12 ILX56-PNC ET200M QuickStart

This chapter covers the configuration of the ILX56-PNC as a PROFINET Master to communicate with an SIEMENS SIMATIC ET200M PROFINET Slave.

12.1 GSDML File Management Tool

12.1.1 Installation

Download the ProSoft PLX50 Configuration Utility from www.prosoft-technology.com.

Run the *PLX50 Configuration Utility Setup.msi* to install the software. Follow the Setup Wizard to complete the installing process.

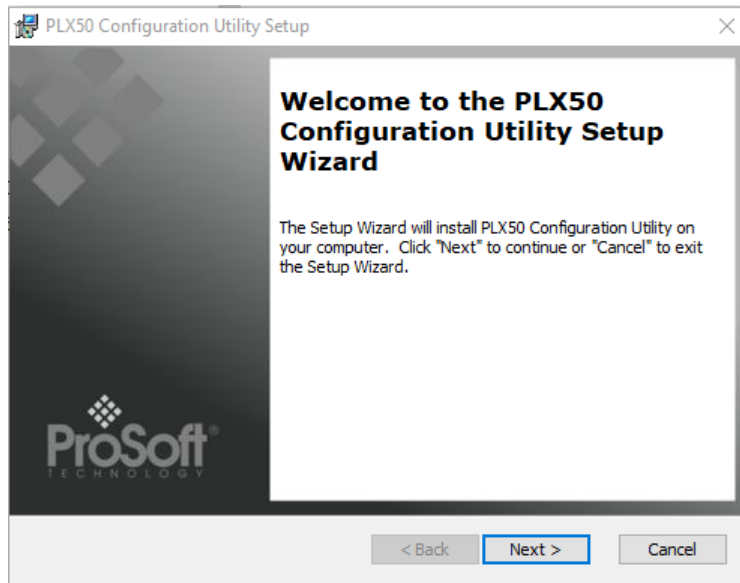

Figure 12.1 – Installation Setup Window

12.1.2 Configuration

The GSDML File Management Tool is opened by selecting **GSDML FILE MANAGEMENT** under the *Tools* menu in the PLX50 Configuration Utility.

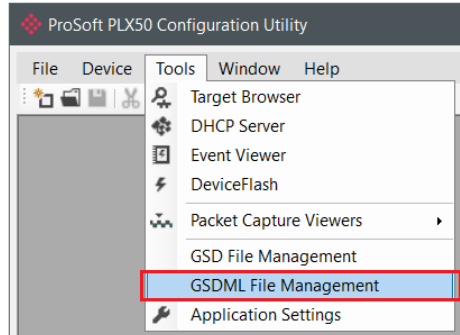

Figure 12.2 – Launch GSDML File Management

Once the tool has been opened, a list of registered PROFINET devices using their GSDML files are displayed.

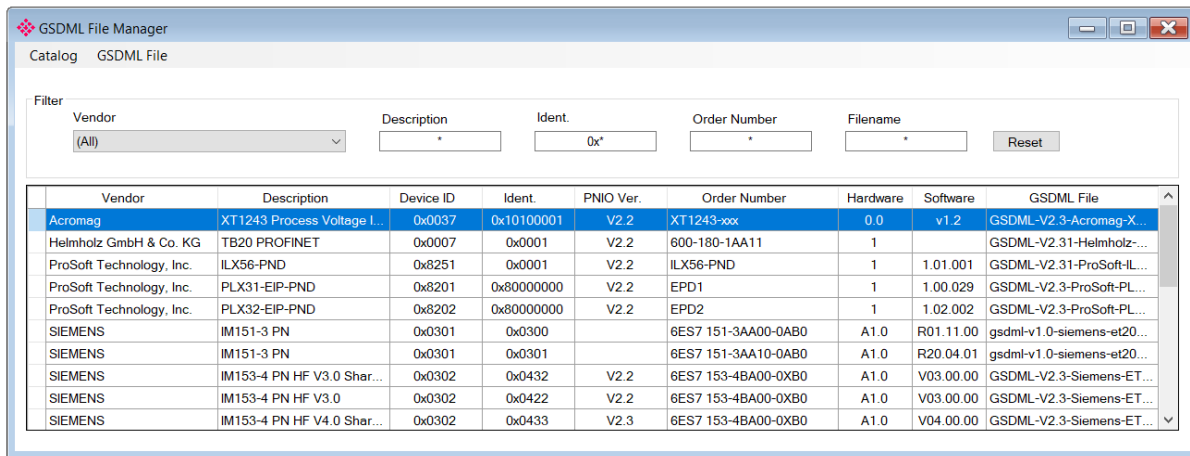

Figure 12.3 – GSDML File Manager

To add a GSDML file, the user will need to click the **ADD** option under the *GSDML File* menu.

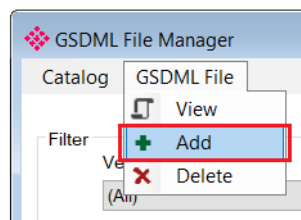

Figure 12.4 – Add GSDML File

Select the GSDML file and click **OPEN**.

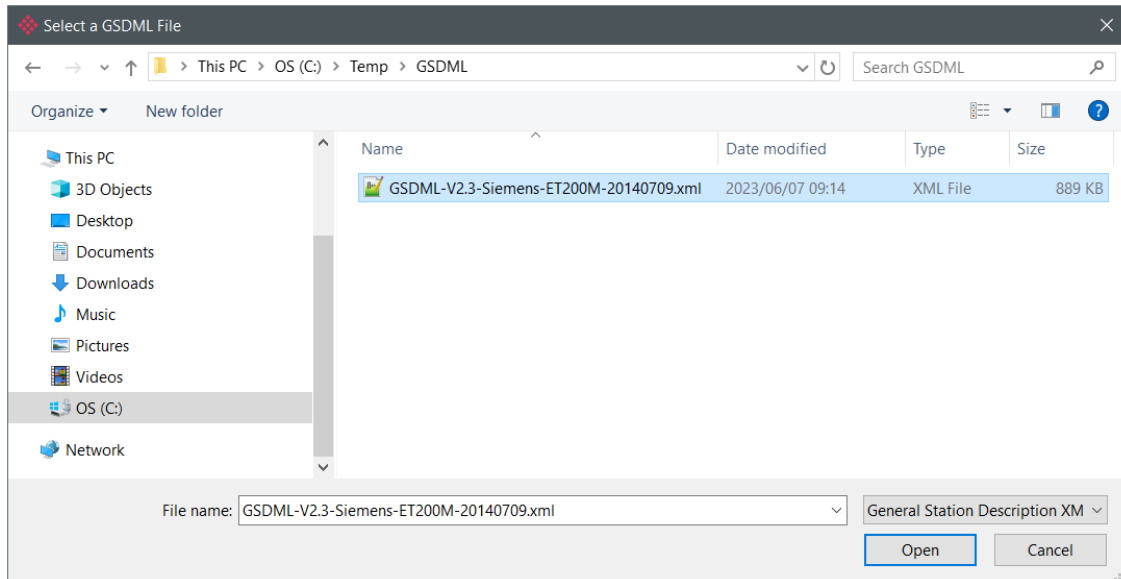

Figure 12.5 – Select GSDML File

Once the file has been selected, the GSDML File Management tool will add the device to the device list and recompile the GSDML catalog.

12.2 Creating a New Project

Note: If the project was started from Studio 5000 Add-On Profile (AOP), this section can be skipped.

Before configuring the module, a new PLX50 Configuration Utility project must be created. Under the *File* menu, select **NEW**.

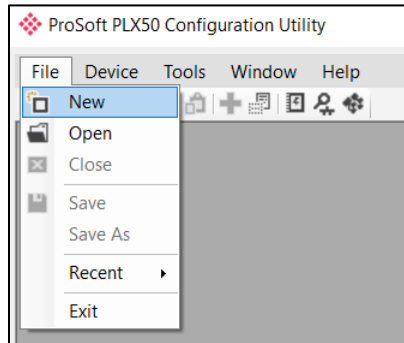

Figure 12.6 – Create New PLX50CU project

A PLX50 Configuration Utility Design Tool project will be created, showing the Project Explorer tree view. A new device can be added by selecting **ADD** under the *Device* menu.

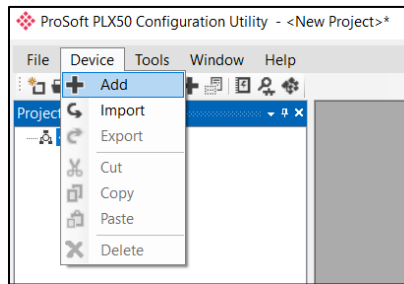

Figure 12.7 – Add new module

In the *Add New Device* window, select the **ILX56-PNC** and click the **OK** button.

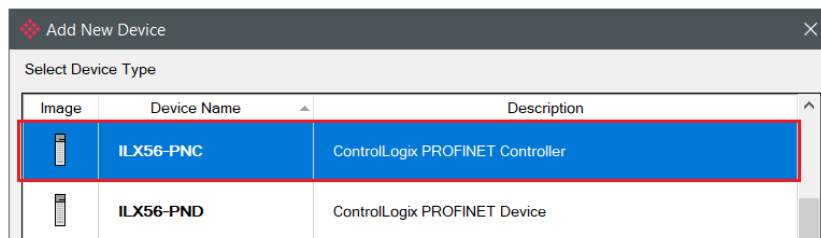

Figure 12.8 – Select ILX56-PNC

The device will appear in the Project Explorer tree with its configuration window opened.

12.2.1 PNC Configuration

Navigate to the *General* tab to update the *Instance Name* and *Base Tag*.

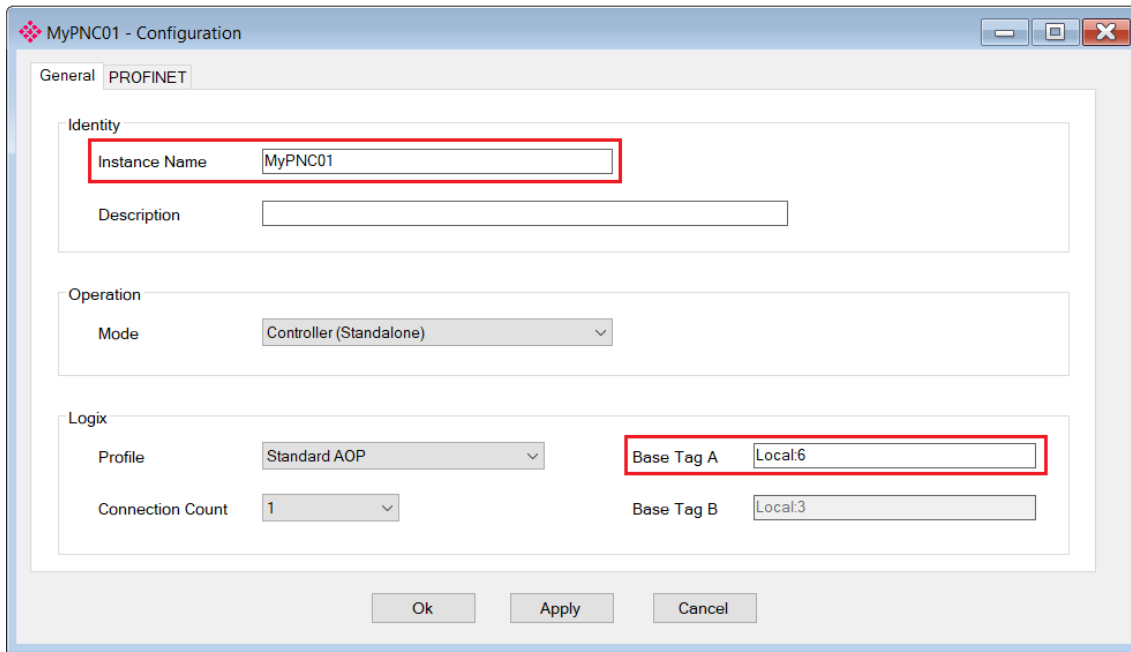

Figure 12.9 – General tab

Navigate to the *PROFINET* tab to update the *IP Address* of the PROFINET network.

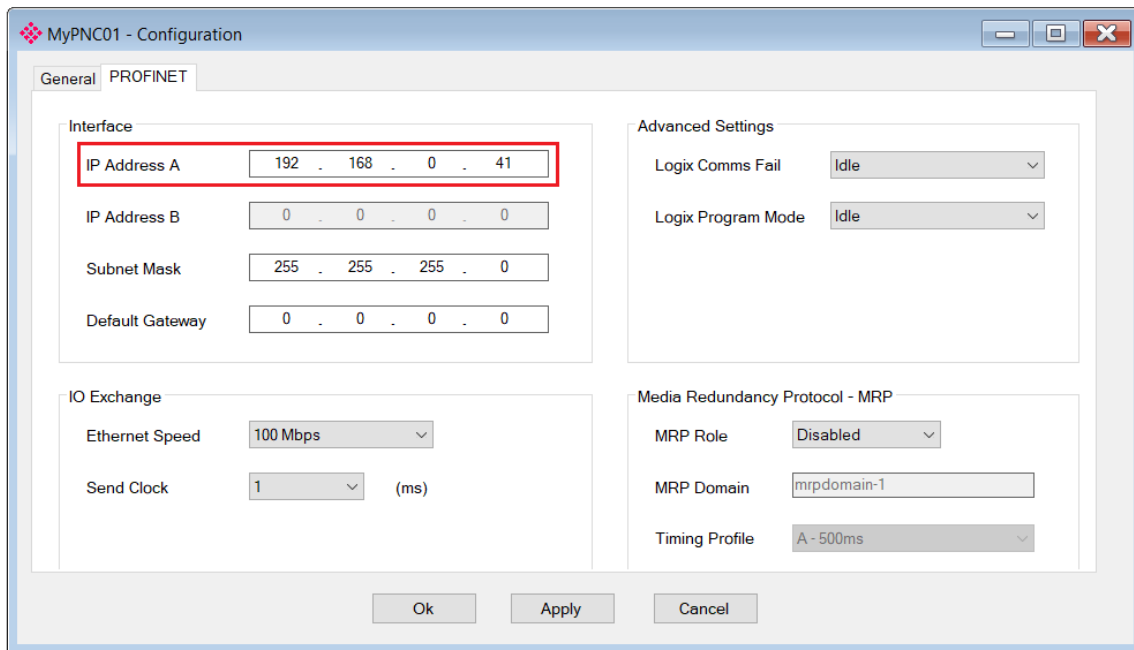

Figure 12.10 – PROFINET tab

Then click **OK**.

12.3 Adding a PROFINET Device

The user will need to add each PROFINET device to the ILX56-PNC. To configure each PROFINET device, right-click on the *PROFINET Devices* item in the tree and select **ADD PROFINET DEVICE**.

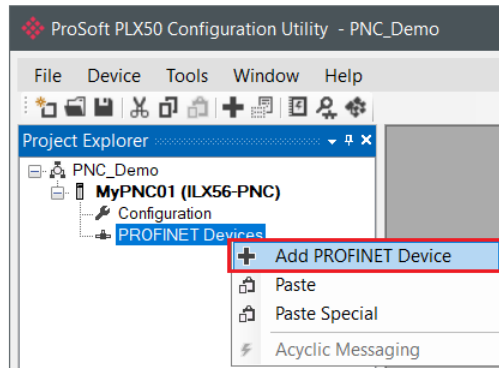

Figure 12.11 – Add new PROFINET device

Once the tool has been opened, a list of registered PROFINET devices using their GSDML files is displayed.

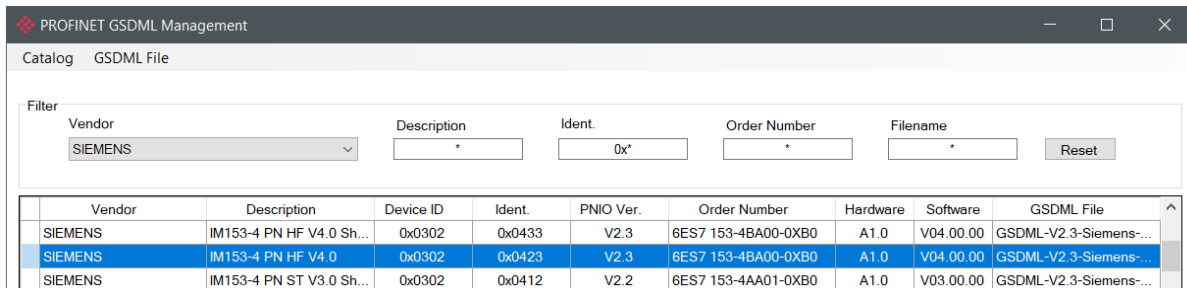

Figure 12.12 – Select device from GSDML catalog

Select the GSDML file of the device to add to the project. Once the device has been added, the *General* tab of the *Configuration* window will be opened. The device will be added to the first open PROFINET Station Address.

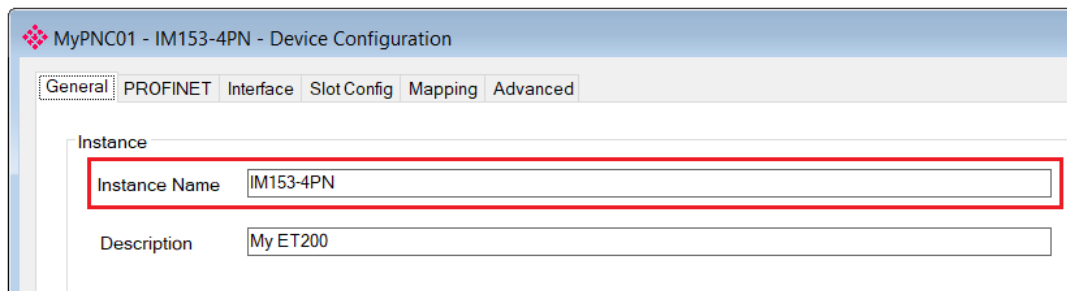

Figure 12.13 – Enter device instance name

Navigate to *PROFINET* Configuration tab to assign the *Device Name* and *IP Address*.

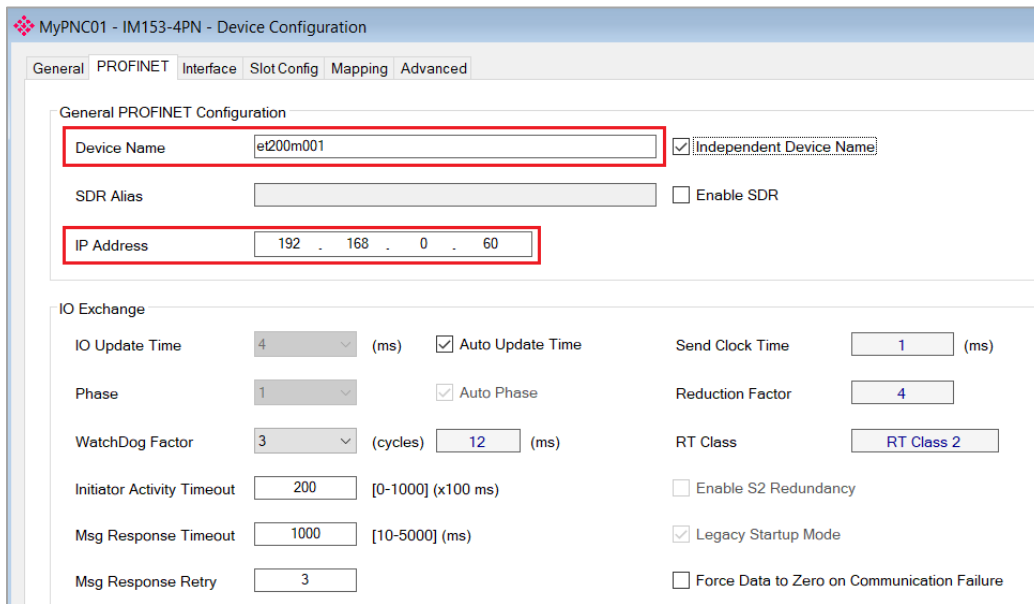

Figure 12.14 – Enter PROFINET device name and IP address

Navigate to the *Slot Configuration* tab. Click **ADD MODULE**.

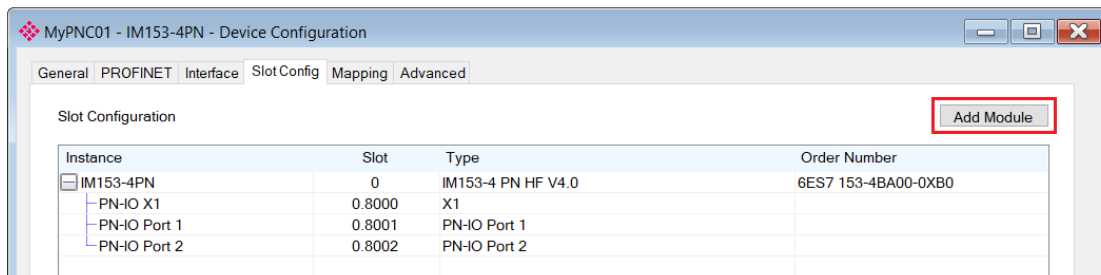

Figure 12.15 – Add module to PROFINET device

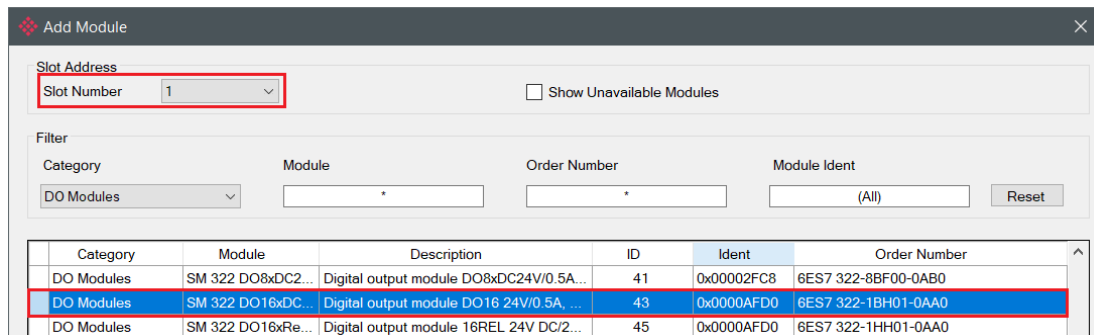

Figure 12.16 – Select the module to add to the selected slot

Add the appropriate modules and click the **OK** button. The ET200M Slave device is now configured in the ProSoft PLX50 Configuration Utility.

12.4 Downloading the Configuration to the ILX56-PNC

Establish a connection path for each module. In the PLX50 Configuration Utility, right-click on the device and select **CONNECTION PATH**.

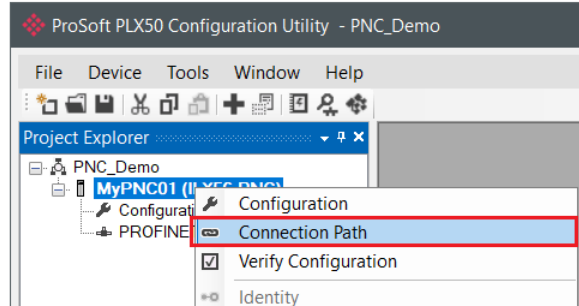

Figure 12.17 – Select Connection Path

Select *Browse* to launch the target browser.

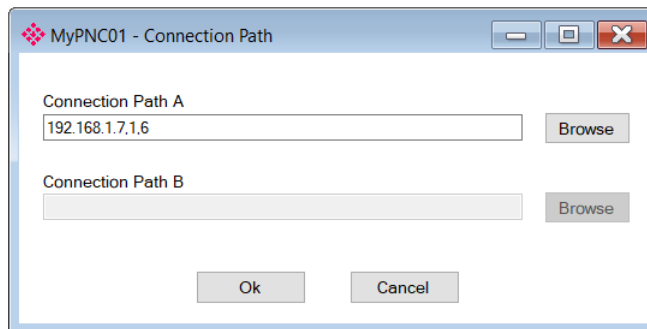

Figure 12.18 – Connection path

Navigate to the ILX56-PNC and click **Ok**.

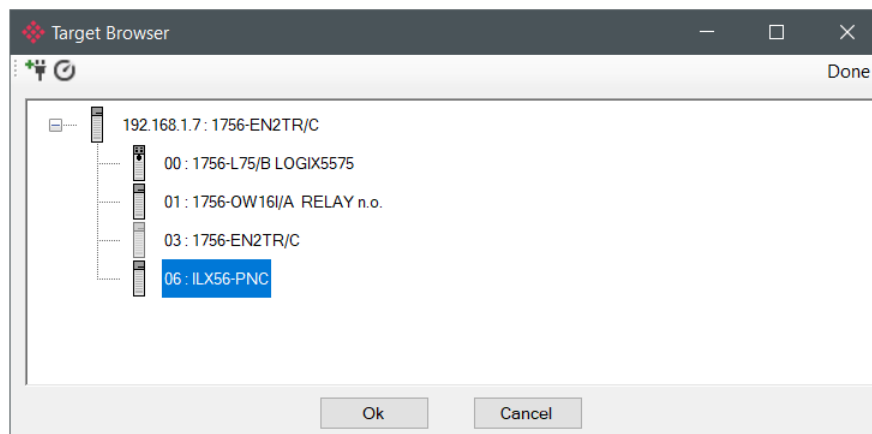

Figure 12.19 – Browse to ILX56-PNC in Target Browser and select the ILX56-PNC

The Connection path will copy to *Connection Path A*. Click **OK**.

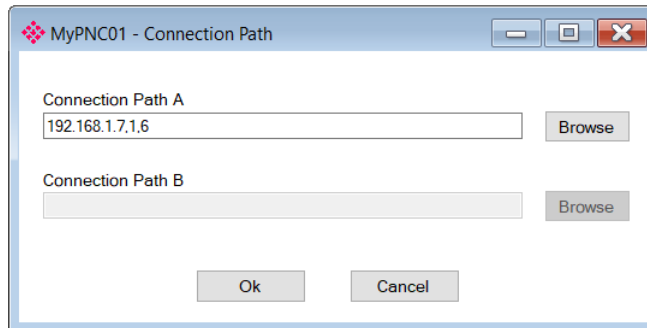

Figure 12.20 – Connection Path A

To download the device configuration, right-click on the ILX56-PNC and select **DOWNLOAD**.

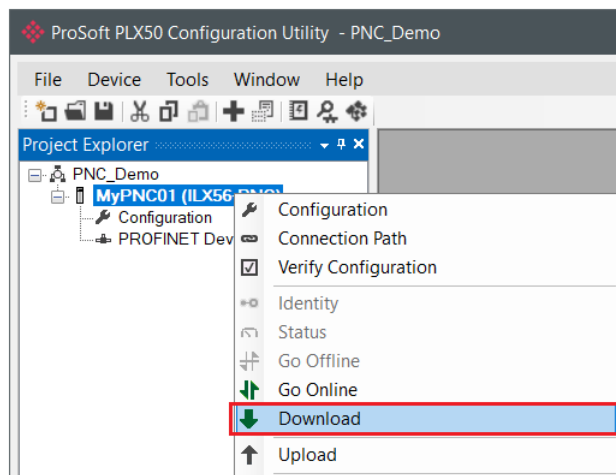

Figure 12.21 – Download PLX50CU configuration to the ILX56-PNC

The PLX50 Configuration Utility device configuration is complete.

12.5 ControlLogix Configuration

The user will need to generate the required Logix and UDTs by right-clicking on the module in the PLX50 Configuration Utility and selecting the **GENERATE LOGIX L5X** option.

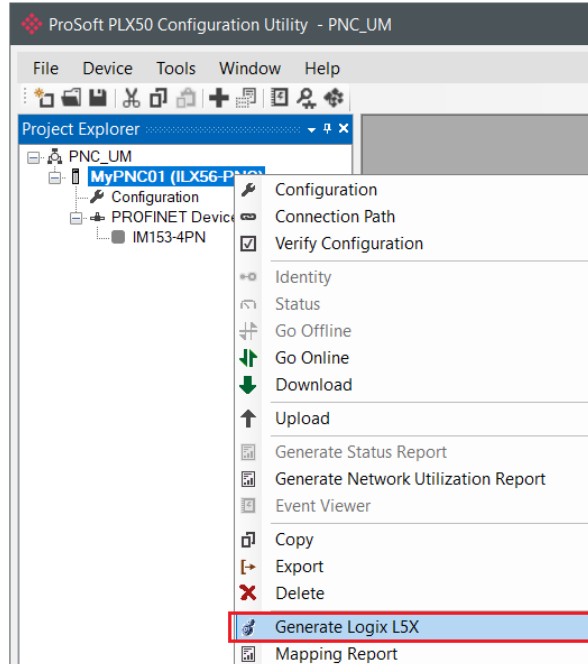

Figure 12.22 – Generate Logix L5X file

Select a suitable file name and path for the L5X file.

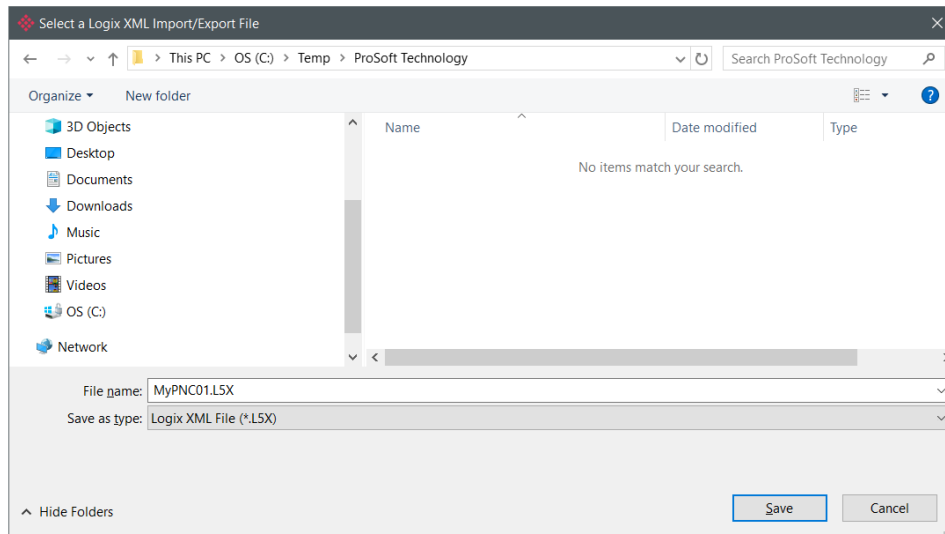

Figure 12.23 – Select folder for Logix L5X file

The L5X file can now be imported into the Studio 5000 project by right-clicking on a suitable *Program* and selecting **ADD > IMPORT ROUTINE**.

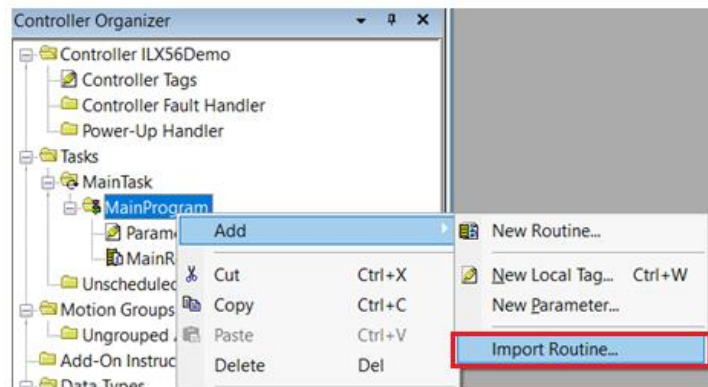

Figure 12.24 – Import Logix L5X file into Studio5000

In the *File Open* dialog, select the L5X file and accept the import by pressing **Ok**.

The import will create the following:

- Mapping Routine
- Multiple UDT (User-Defined Data Types)
- Multiple Controller Tags

Since the imported mapping routine is not a Main Routine, it will need to be called from the current Main Routine.

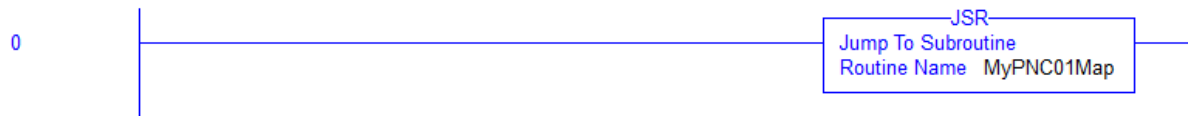

Figure 12.25 – Add Jump Routine to Main Routine

The PROFINET device icon changes to green during successful data exchange.

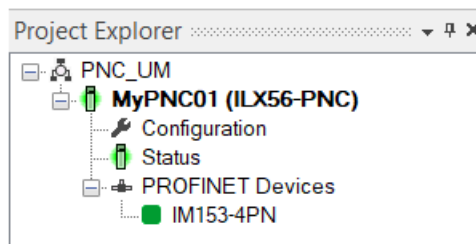

Figure 12.26 – PROFINET device online and exchanging data

12.6 Cyclic Data

ET200M

To write cyclic data to the ET200M device, navigate to the appropriate controller tags and enter the bits to energize in the output module.

Name	Value	Style	Data Type
MyPNC01_IM1534PN	{...}		MyPNC01_002A0302C8F1
MyPNC01_IM1534PN.PNInput	{...}		MyPNC01_002A0302C8F1PNInput
MyPNC01_IM1534PN.PNOutput	{...}		MyPNC01_002A0302C8F1PNOutput
MyPNC01_IM1534PN.PNOutput.Control	{...}		PSILX56PNDeviceControl
MyPNC01_IM1534PN.PNOutput.S01_Outputs	{...}	Decimal	SINT[2]
MyPNC01_IM1534PN.PNOutput.S01_Outputs[0]	0	Decimal	SINT
MyPNC01_IM1534PN.PNOutput.S01_Outputs[0].0	0	Decimal	BOOL
MyPNC01_IM1534PN.PNOutput.S01_Outputs[0].1	0	Decimal	BOOL
MyPNC01_IM1534PN.PNOutput.S01_Outputs[0].2	0	Decimal	BOOL
MyPNC01_IM1534PN.PNOutput.S01_Outputs[0].3	0	Decimal	BOOL

Figure 12.27 – Writing data to the ET200M

13 Support, Service, and Warranty

13.1 Contacting Technical Support

ProSoft Technology, Inc. is committed to providing the most efficient and effective support possible. Before calling, please gather the following information to assist in expediting this process:

- 1 Product Version Number
- 2 System architecture
- 3 Network details

If the issue is hardware related, we will also need information regarding:

- 1 Module configuration and associated ladder files, if any
- 2 Module operation and any unusual behavior
- 3 Configuration/Debug status information
- 4 LED patterns
- 5 Details about the interfaced serial, Ethernet or Fieldbus devices

North America (Corporate Location) Phone: +1 661-716-5100 ps.prosofttechnology@belden.com Languages spoken: English, Spanish REGIONAL TECH SUPPORT ps.support@belden.com	Europe / Middle East / Africa Regional Office Phone: +33.(0)5.34.36.87.20 ps.europe@belden.com Languages spoken: English, French, Hindi, Italian REGIONAL TECH SUPPORT ps.support.emea@belden.com
Latin America Regional Office Phone: +52.222.264.1814 ps.latinam@belden.com Languages spoken: English, Spanish, Portuguese REGIONAL TECH SUPPORT ps.support.la@belden.com	Asia Pacific Regional Office Phone: +60.3.2247.1898 ps.asiapc@belden.com Languages spoken: Bahasa, Chinese, English, Hindi, Japanese, Korean, Malay REGIONAL TECH SUPPORT ps.support.ap@belden.com

For additional ProSoft Technology contacts in your area, please see:

www.prosoft-technology.com/About-Us/Contact-Us

13.2 Warranty Information

For details regarding ProSoft Technology's legal terms and conditions, please see:

www.prosoft-technology.com/ProSoft-Technology-Legal-Terms-and-Conditions

For Return Material Authorization information, please see:

www.prosoft-technology.com/Services-Support/Return-Material-Instructions