



**ProLinX**<sup>®</sup>  
**DH485**

**ProLinX Gateway**

DH485 Interface

August 27, 2009

## Important Installation Instructions

Power, Input and Output (I/O) wiring must be in accordance with Class I, Division 2 wiring methods, Article 501-4 (b) of the National Electrical Code, NFPA 70 for installation in the U.S., or as specified in Section 18-1J2 of the Canadian Electrical Code for installations in Canada, and in accordance with the authority having jurisdiction. The following warnings must be heeded:

- A** WARNING - EXPLOSION HAZARD - SUBSTITUTION OF COMPONENTS MAY IMPAIR SUITABILITY FOR CLASS I, DIV. 2;
- B** WARNING - EXPLOSION HAZARD - WHEN IN HAZARDOUS LOCATIONS, TURN OFF POWER BEFORE REPLACING OR WIRING MODULES
- C** WARNING - EXPLOSION HAZARD - DO NOT DISCONNECT EQUIPMENT UNLESS POWER HAS BEEN SWITCHED OFF OR THE AREA IS KNOWN TO BE NONHAZARDOUS.
- D** THIS DEVICE SHALL BE POWERED BY CLASS 2 OUTPUTS ONLY.

### All ProLinx<sup>®</sup> Products

WARNING – EXPLOSION HAZARD – DO NOT DISCONNECT EQUIPMENT UNLESS POWER HAS BEEN SWITCHED OFF OR THE AREA IS KNOWN TO BE NON-HAZARDOUS.

AVERTISSEMENT – RISQUE D'EXPLOSION – AVANT DE DÉCONNECTER L'EQUIPMENT, COUPER LE COURANT OU S'ASSURER QUE L'EMPLACEMENT EST DÉSIGNÉ NON DANGEREUX.

### Markings

UL/cUL	ISA 12.12.01 Class I, Div 2 Groups A, B, C, D
cUL	C22.2 No. 213-M1987



CL I Div 2 GPs A, B, C, D

Temp Code T5

II 3 G

Ex nA nL IIC T5 X

0° C ≤ Ta ≤ 60° C

II – Equipment intended for above ground use (not for use in mines).

3 – Category 3 equipment, investigated for normal operation only.

G – Equipment protected against explosive gasses.

### ProLinx Gateways with Ethernet Ports

Series C ProLinx™ Gateways with Ethernet ports do **NOT** include the HTML Web Server. The HTML Web Server must be ordered as an option. This option requires a factory-installed hardware addition. The HTML Web Server now supports:

- 8 MB file storage for HTML files and associated graphics files (previously limited to 384K)
- 32K maximum HTML page size (previously limited to 16K)

### To upgrade a previously purchased Series C model:

Contact your ProSoft Technology distributor to order the upgrade and obtain a Returned Merchandise Authorization (RMA) to return the unit to ProSoft Technology.

## ***To Order a ProLinX Plus gateway with the -WEB option:***

Add **-WEB** to the standard ProLinX part number. For example, **5201-MNET-MCM-WEB**.

## **Your Feedback Please**

We always want you to feel that you made the right decision to use our products. If you have suggestions, comments, compliments or complaints about the product, documentation, or support, please write or call us.

### **ProSoft Technology**

5201 Truxtun Ave., 3rd Floor  
Bakersfield, CA 93309  
+1 (661) 716-5100  
+1 (661) 716-5101 (Fax)  
www.prosoft-technology.com  
support@prosoft-technology.com

Copyright © ProSoft Technology, Inc. 2009. All Rights Reserved.

DH485 Driver Manual  
August 27, 2009

ProSoft Technology<sup>®</sup>, ProLinX<sup>®</sup>, inRAx<sup>®</sup>, ProTalk<sup>®</sup>, and RadioLinX<sup>®</sup> are Registered Trademarks of ProSoft Technology, Inc. All other brand or product names are or may be trademarks of, and are used to identify products and services of, their respective owners.

## **ProSoft Technology<sup>®</sup> Product Documentation**

In an effort to conserve paper, ProSoft Technology no longer includes printed manuals with our product shipments. User Manuals, Datasheets, Sample Ladder Files, and Configuration Files are provided on the enclosed CD-ROM, and are available at no charge from our web site: [www.prosoft-technology.com](http://www.prosoft-technology.com)

Printed documentation is available for purchase. Contact ProSoft Technology for pricing and availability.

North America: +1.661.716.5100

Asia Pacific: +603.7724.2080

Europe, Middle East, Africa: +33 (0) 5.3436.87.20

Latin America: +1.281.298.9109



# Contents

Important Installation Instructions .....	2
Your Feedback Please.....	3
ProSoft Technology® Product Documentation.....	3
<b>1 Start Here</b> .....	<b>7</b>
1.1 System Requirements .....	7
1.2 Package Contents .....	8
1.3 Mounting the module on the DIN-rail .....	8
1.4 Connecting Power to the Unit .....	9
1.5 Install ProSoft Configuration Builder Software .....	9
<b>2 Functional Overview</b> .....	<b>11</b>
2.1 Master/Slave Serial Port.....	11
2.2 Module Internal Database .....	11
2.3 Protocol Functional Specifications .....	15
<b>3 Configure the Module</b> .....	<b>17</b>
3.1 Configuring Module Parameters .....	19
3.2 Comment Entries.....	20
3.3 Printing a Configuration File .....	20
3.4 [DH485 Port x].....	21
3.5 [DH485 Port x Commands] .....	24
3.6 [DH485 Port x Maps] .....	27
3.7 Downloading a File from PC to the Module.....	28
<b>4 Serial Port Protocol Error/Status Data</b> .....	<b>29</b>
4.1 Viewing Error and Status Data .....	29
4.2 DH485 Error and Status Data Area Addresses .....	29
<b>5 Reference</b> .....	<b>33</b>
5.1 Status Data Area .....	33
5.2 Command Error List Data Area .....	34
5.3 RS-232 .....	34
5.4 RS-485 .....	34
<b>6 Support, Service &amp; Warranty</b> .....	<b>37</b>
6.1 How to Contact Us: Technical Support .....	37
6.2 Return Material Authorization (RMA) Policies and Conditions.....	38
6.3 LIMITED WARRANTY.....	39

**Index**

**43**

---

# 1 Start Here

## *In This Chapter*

❖ System Requirements .....	7
❖ Package Contents .....	8
❖ Mounting the module on the DIN-rail .....	8
❖ Connecting Power to the Unit.....	9
❖ Install ProSoft Configuration Builder Software.....	9

## 1.1 System Requirements

The ProSoft Configuration Builder configuration software for the DH485 module requires the following minimum hardware and software components:

- Pentium® II 450 MHz minimum. Pentium III 733 MHz (or better) recommended
- Supported operating systems:
  - Microsoft Windows Vista
  - Microsoft Windows XP Professional with Service Pack 1 or 2
  - Microsoft Windows 2000 Professional with Service Pack 1, 2, or 3
  - Microsoft Windows Server 2003
- 128 Mbytes of RAM minimum, 256 Mbytes of RAM recommended
- 100 Mbytes of free hard disk space (or more based on application requirements)
- 256-color VGA graphics adapter, 800 x 600 minimum resolution (True Color 1024 × 768 recommended)
- CD-ROM drive

## 1.2 Package Contents

The following components are included with your DH485 module, and are all required for installation and configuration.

**Important:** Before beginning the installation, please verify that all of the following items are present.

Qty.	Part Name	Part Number	Part Description
1	DH485 module	PLX-####	ProLinx communication gateway module
1	Cable	Cable #15, RS232 Null Modem	For RS232 Connection from a PC to the CFG Port of the module
Varies	Cable	Cable #9, Mini-DIN8 to DB9 Male Adapter	For DB9 Connection to module's Port. One DIN to DB-9M cable included per configurable serial port, plus one for module configuration
Varies	Adapter	1454-9F	Adapters, DB9 Female to Screw Terminal. For RS422 or RS485 Connections to each serial application port of the module
1	ProSoft Solutions CD		Contains sample programs, utilities and documentation for the DH485 module.

If any of these components are missing, please contact ProSoft Technology Support for replacements.

## 1.3 Mounting the module on the DIN-rail

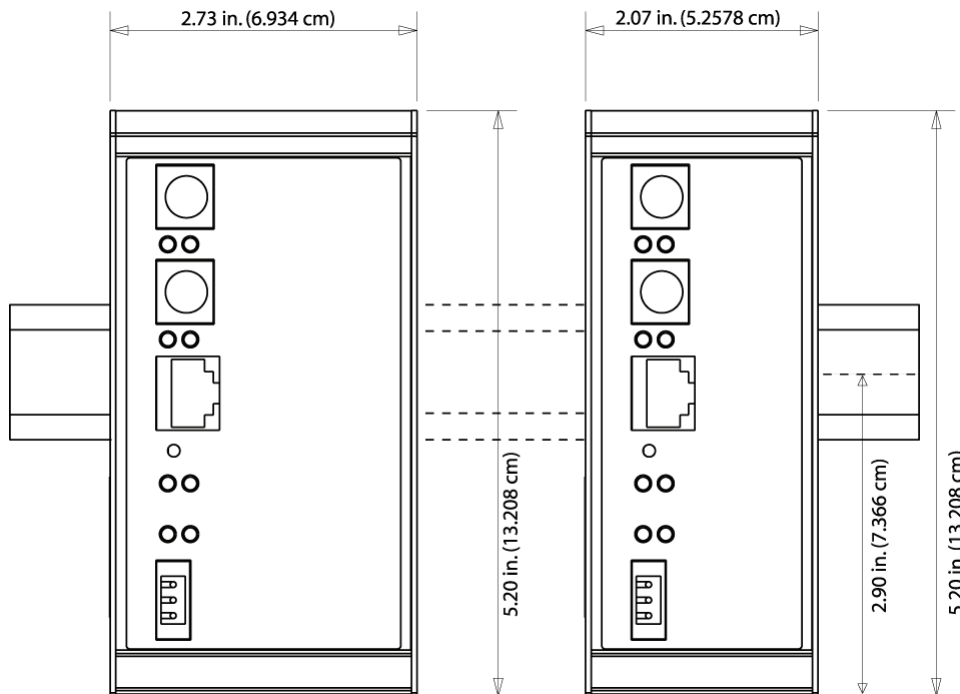

ProLinx 5000/6000 Series module



## 1.4 Connecting Power to the Unit

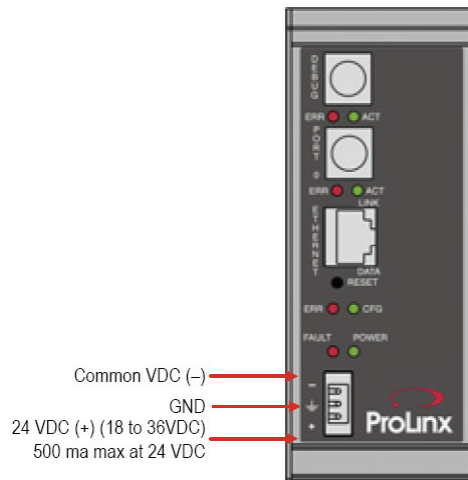

**WARNING:** Ensure that you do not reverse polarity when applying power to the module. This will cause damage to the module's power supply.

## 1.5 Install ProSoft Configuration Builder Software

You must install the ProSoft Configuration Builder (PCB) software in order to configure the module. You can always get the newest version of ProSoft Configuration Builder from the ProSoft Technology web site.

### To install ProSoft Configuration Builder from the ProSoft Web Site

- 1 Open your web browser and navigate to <http://www.prosoft-technology.com/pcb>
- 2 Click the **DOWNLOAD HERE** link to download the latest version of ProSoft Configuration Builder.
- 3 Choose **"SAVE"** or **"SAVE FILE"** when prompted.
- 4 Save the file to your Windows Desktop, so that you can find it easily when you have finished downloading.
- 5 When the download is complete, locate and open the file, and then follow the instructions on your screen to install the program.

If you do not have access to the Internet, you can install ProSoft Configuration Builder from the ProSoft Solutions CD-ROM, included in the package with your module.

### To install ProSoft Configuration Builder from the Product CD-ROM

- 1 Insert the ProSoft Solutions Product CD-ROM into the CD-ROM drive of your PC. Wait for the startup screen to appear.
- 2 On the startup screen, click **PRODUCT DOCUMENTATION**. This action opens an Windows Explorer file tree window.

- 3 Click to open the **UTILITIES** folder. This folder contains all of the applications and files you will need to set up and configure your module.
- 4 Double-click the **SETUPCONFIGURATIONTOOL** folder, double-click the "**PCB\_\*.EXE**" file and follow the instructions on your screen to install the software on your PC. The information represented by the "\*" character in the file name is the PCB version number and, therefore, subject to change as new versions of PCB are released.

**Note:** Many of the configuration and maintenance procedures use files and other utilities on the CD-ROM. You may wish to copy the files from the Utilities folder on the CD-ROM to a convenient location on your hard drive.

### ***1.5.1 Using the Help System***

Most of the information needed to help you use ProSoft Configuration Builder is provided in a Help System that is always available whenever you are running ProSoft Configuration Builder. The Help System does not require an Internet connection.

To view the help pages, start ProSoft Configuration Builder, open the **HELP** menu, and then choose **CONTENTS**.

## 2 Functional Overview

### In This Chapter

- ❖ Master/Slave Serial Port..... 11
- ❖ Module Internal Database ..... 11
- ❖ Protocol Functional Specifications..... 15

The DH-485 protocol driver is designed to accept DH-485 commands from an attached DH-485 master unit (that is, SLC 5/03 processor ladder logic message instruction). The DH-485 driver permits a remote master to interact with all data contained in a module. The data can be derived from other DH-485 devices on the network through a master port on a module. The driver actively issues DH-485 commands to other nodes on the DH-485 network. One hundred user-defined commands are supported by the driver on each port.

### 2.1 Master/Slave Serial Port

Master mode issues read or write commands to other remote devices on the DH-485 network. These commands are user-configured in the module via the master command list received from the configuration file. Command status is returned to the processor for each individual command in the command list status data area. The location of this status block in a module's internal database is user-defined.

The slave driver mode allows a module to respond to CIF and data read and write commands issued by a remote node on the DH-485 network.

The Slave driver supports the following DH-485 command set:

Type	Access	Description
CIF	Read	485CIF, Peer-to-Peer, Read MSG requests
CIF	Write	485CIF, Peer-to-Peer, Write MSG requests
Data Table	Read	500CPU, Peer-to-Peer, Read MSG requests
Data Table	Write	500CPU, Peer-to-Peer, Write MSG requests

### 2.2 Module Internal Database

Central to the functionality of the module is the internal database. This database is shared between all the ports on the module and is used as a conduit to pass information from one device on one network to one or more devices on another network. This permits data from devices on one communication port to be viewed and controlled by devices on another port. In addition to data from the slave and master ports, status and error information generated by the module can also be mapped into the internal database.

### 2.2.1 DH485 Serial Port Driver Access to Database

The module supports the common interface file (CIF) of the DH-485 protocol. A separate data area can be defined for each application port. This data area is divided into read and write data and is mapped into the module's internal database. The module's application constantly transfers the read CIF data from the CIF database to the module database and the write CIF data from the module to the CIF database. The parameters used to define the CIF database are contained in the configuration file. This optional feature of the module should only be utilized if required by a remote master on the network. Otherwise, the data file functions (500CPU message) instructions should be used to access and control the module's data. The following diagram shows the relationship of the DH-485 drivers, the CIF database and the module's database:

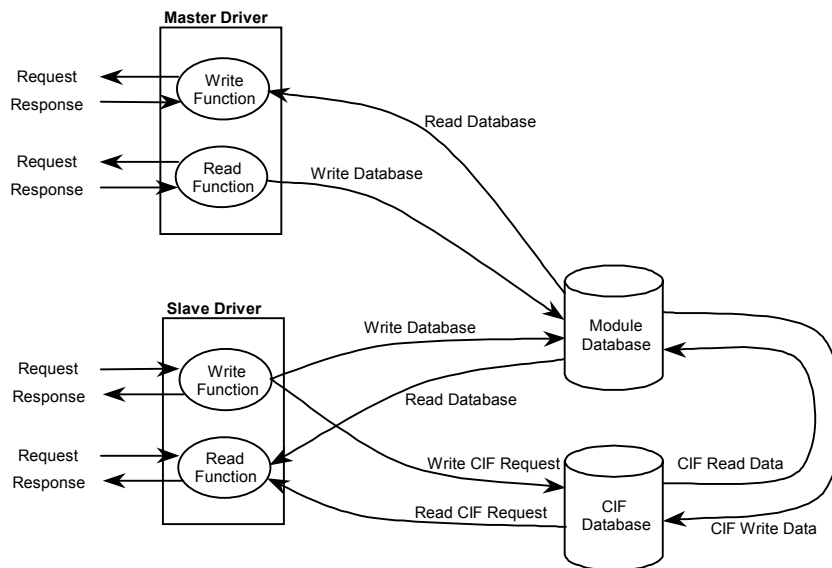

The Master driver uses the database in two ways:

- 1 A read command issued to a slave device by the master driver will return the slave data into the internal database
- 2 A write command issued to a slave device by the master driver uses the data in the internal database to write to the slave device. The slave driver accesses data from the internal database. External DH-485 master devices can monitor and control data in this database through the slave port. Setup of the slave port only requires the CFG file.

The module supports the common interface file (CIF) of the DH-485 protocol. A separate data area can be defined for each application port. This data area is divided into read and write data and is mapped into the module's internal database. The module's application constantly transfers the read CIF data from the CIF database to the module database and the write CIF data from the module to the CIF database. The parameters used to define the CIF database are contained in the configuration file. This optional feature of the module should only be utilized if required by a remote master on the network. Otherwise, the data file functions (500CPU message) instructions should be used to access and control the module's data. The following diagram shows the relationship of the DH-485 drivers, the CIF database and the module's database:

Parameter	Value	Format
Read Register Start	600	Word
Read Register Count	600	Word
Write Register Start	0	Word
Write Register Count	600	Word
CIF Read DB Offset	1200	Byte
CIF Read Count	144	Byte
CIF Write DB Offset	0	Byte

### 2.2.2 DH-485 CIF Information

The following illustration shows four different uses and configurations of the CIF data area:

#### Example #1

CIF Read DB Offset: 1000  
 CIF Read Count: 244  
 CIF Write DB Offset: -1

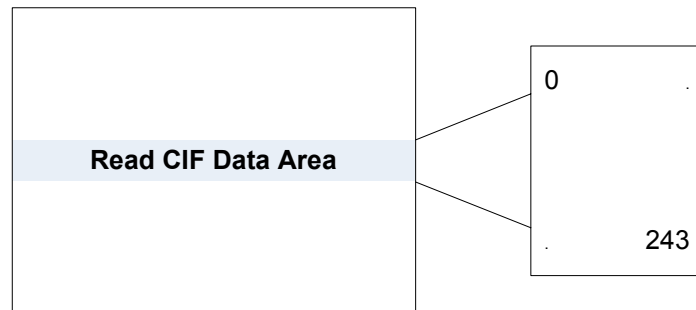

**Example #2**

CIF Read DB Offset: -1  
 CIF Read Count: 0  
 CIF Write DB Offset: 1000

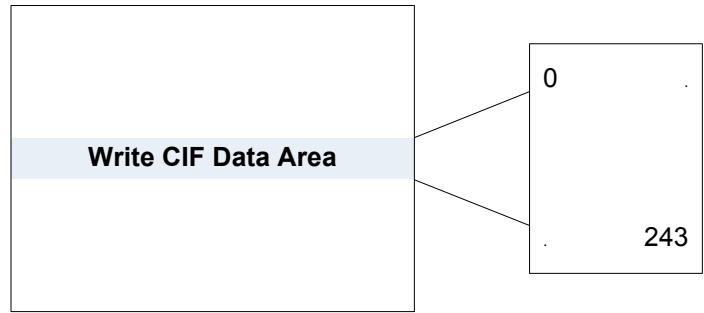

**Example #3**

CIF Read DB Offset: 1000  
 CIF Read Count: 124  
 CIF Write DB Offset: 2000

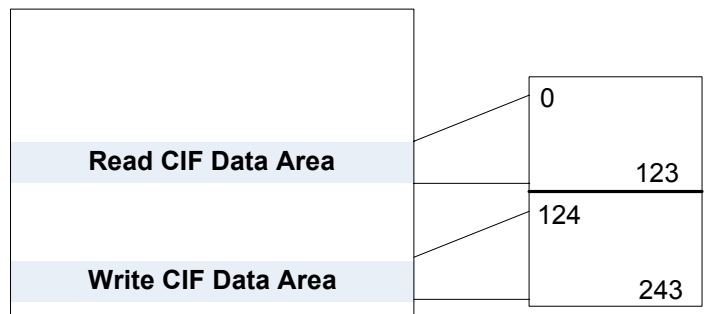

**Example #4**

CIF Read DB Offset: -1  
 CIF Read Count: 0  
 CIF Write DB Offset: -1

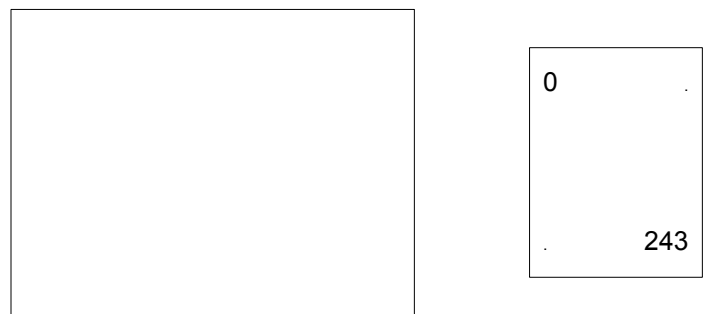

Example 1 only uses CIF read data and utilizes the maximum read data area.

Example 2 only uses the CIF write data and utilizes the maximum write data area.

Example 3 uses both CIF read and write data. 124 bytes of read data are used and 120 bytes of write data are used.

Example 4 does not use the CIF data in the application.

## 2.3 Protocol Functional Specifications

### 2.3.1 Functional Specifications - DH-485

The DH-485 protocol in its native form is a peer to peer token passing network. The ProLinx DH-485 driver accesses the network functioning either as a Master or as a Slave.

---

#### General Protocol Information

---

Error Checking	BCC and CRC
Communication Parameters	Local Station ID: 0 to 31 Port 0 Baud Rate: 110 to 38.4K baud Port 1 Baud Rate: 110 to 19200 baud Stop Bits: 1 or 2 Data Size: 7 or 8 bits Parity: None, Even, Odd RTS Timing delays: 0 to 65535 milliseconds

---

#### DH-485 Slave Mode

In Slave mode, the module accepts commands from one or more Masters to read/write data stored in the module's internal data memory. In this mode, the ProLinx unit is answering DH-485 commands and has the appearance of an SLC processor to the network.

#### DH-485 Master Mode

In Master mode, the ProLinx DH-485 driver will actively gather data from other devices on the network, controlling the read/write data transfer between the gateway and other DH-485 devices, such as SLC processors. Data transfer can be initiated and executed with the other devices without any ladder logic being required in the Rockwell Automation slave hardware.

---

#### DH485 Functioning as a Master

---

Command List	Up to 100 command per master port, each fully configurable for function, slave address, register to/from addressing and word/bit count
Polling of command list	User configurable polling of commands, including disabled, continuous and on change of data (write only)

---

### 2.3.2 General Specifications

ProLinx® Communication Gateways provide connectivity for two or more dissimilar network types. The gateways, encased in sturdy extruded aluminum, are stand-alone DIN-rail mounted solutions that provide data transfer between many of today's most widely used industrial automation protocols.

### 2.3.3 Hardware Specifications

Specification	Description
Power Supply	24 VDC nominal 18 to 32 VDC allowed Positive, Negative, GND Terminals 2.5 mm screwdriver blade
Current Load	500 mA max@ 32 VDC max
Operating Temperature	-20 to 50°C (-4 to 122°F)
Storage Temperature	-40 to 85°C (-40 to 185°F)
Relative Humidity	5% to 95% (non-condensing)
Dimensions	Standard: 5.20 H x 2.07 W x 4.52 D inches (13.2 cm H x 5.25 cm W x 11.48cm D) Extended: 5.20 H x 2.73 W x 4.52 D inches (13.2 cm H x 6.934 cm W x 11.48cm D)
LED Indicators	Power and Module Status Application Status Serial Port Activity LED Serial Activity and Error LED Status
Configuration Serial Port	DB-9M RS-232 only No hardware handshaking
Ethernet Port (Ethernet protocol gateways only)	10Base-T half duplex RJ45 Connector Link and Activity LED indicators Electrical Isolation 1500 V rms at 50 Hz to 60 Hz for 60 s, applied as specified in section 5.3.2 of IEC 60950: 1991 Ethernet Broadcast Storm Resiliency = less than or equal to 5000 [ARP] frames-per-second and less than or equal to 5 minutes duration
Application Serial Ports	RS-232/422/485 RS-232 handshaking configurable RS-422/485 screw termination included
Serial Port Isolation	2500V RMS port signal isolation per UL 1577 3000V DC min. isolation port to ground and port to logic
Shipped with Each Unit	Mini-DIN to DB-9M serial cables 4 ft RS-232 configuration cable 2.5mm screwdriver CD (docs and Configuration utility) RS-422/485 DB-9 to Screw Terminal Adaptor (1 or 4, depending on ports)



### 3 Configure the Module

#### *In This Chapter*

- ❖ Configuring Module Parameters ..... 19
- ❖ Comment Entries ..... 20
- ❖ Printing a Configuration File ..... 20
- ❖ [DH485 Port x] ..... 21
- ❖ [DH485 Port x Commands] ..... 24
- ❖ [DH485 Port x Maps] ..... 27
- ❖ Downloading a File from PC to the Module ..... 28

To begin, start **PROSOFT CONFIGURATION BUILDER (PCB)**.

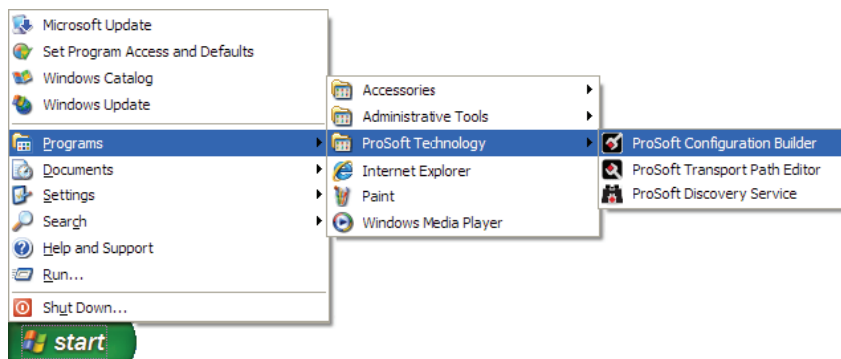

If you have used other Windows configuration tools before, you will find the screen layout familiar. PCB's window consists of a tree view on the left, and an information pane and a configuration pane on the right side of the window. When you first start *PCB*, the tree view consists of folders for **DEFAULT PROJECT** and **DEFAULT LOCATION**, with a **DEFAULT MODULE** in the Default Location folder. The following illustration shows the *PCB* window with a new project.

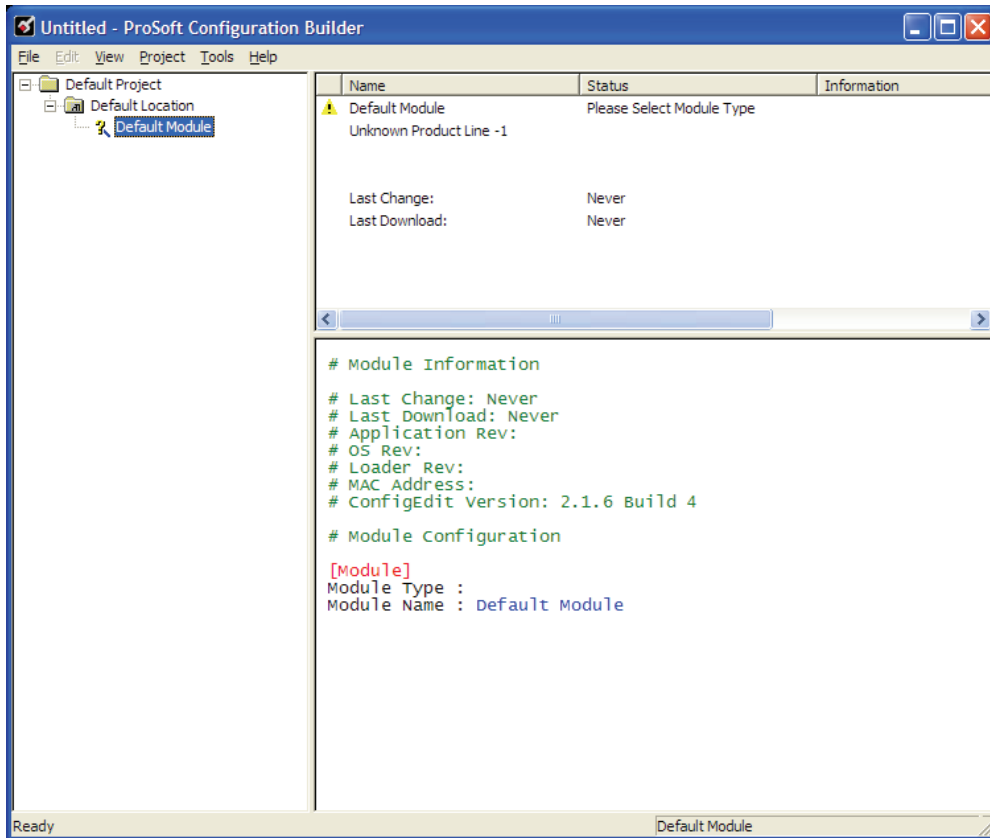

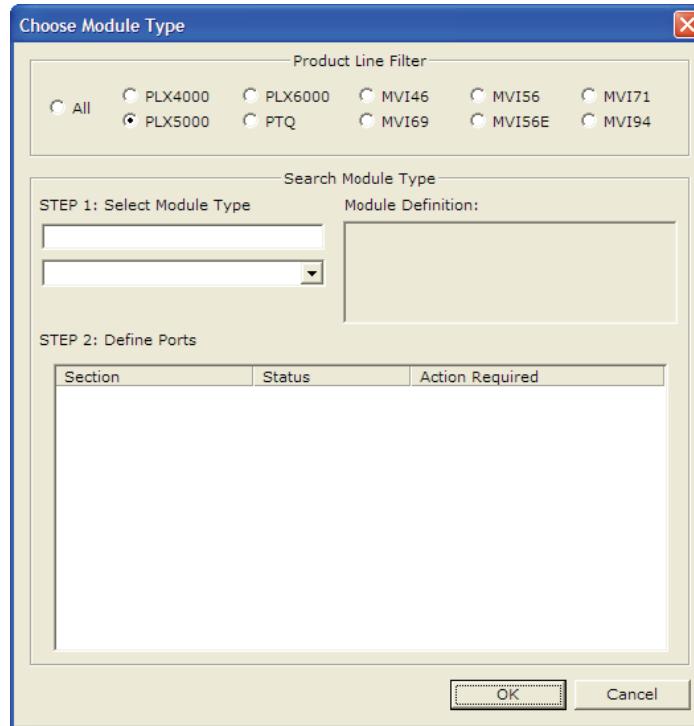

Your first task is to add the DH485 module to the project.

- 1 Use the mouse to select **DEFAULT MODULE** in the tree view, and then click the right mouse button to open a shortcut menu.
- 2 On the shortcut menu, choose **CHOOSE MODULE TYPE**. This action opens the **CHOOSE MODULE TYPE** dialog box.





- 3 In the **PRODUCT LINE FILTER** area of the dialog box, select the ProLinx Series (4000, 5000, or 6000) for your gateway.
- 4 In the **SELECT MODULE TYPE** dropdown list, select your gateway, and then click **OK** to save your settings and return to the ProSoft Configuration Builder window.

### 3.1 Configuring Module Parameters

- 1 Click on the plus sign next to the  icon to expand module information.
- 2 Double-click the  icon to open the **EDIT** dialog box.
- 3 To edit a parameter, select the parameter in the left pane and make your changes in the right pane.
- 4 Click **OK** to save your changes.

### 3.2 Comment Entries

- 1 Click the plus sign to the left of the  Comment icon to expand the module Comments.
- 2 Double-click the  Module Comment icon. The **EDIT - MODULE COMMENT** dialog appears.

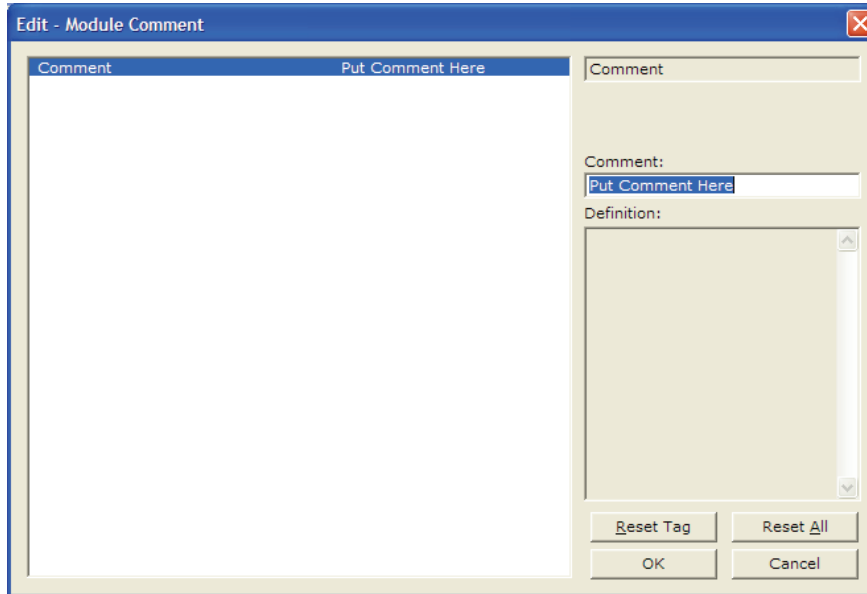

- 3 Enter your comment and click **OK** to save your changes.

### 3.3 Printing a Configuration File

- 1 Select the **MODULE** icon, and then click the right mouse button to open a shortcut menu.
- 2 On the shortcut menu, choose **VIEW CONFIGURATION**. This action opens the **VIEW CONFIGURATION** window.
- 3 On the **VIEW CONFIGURATION** window, open the **FILE** menu, and choose **PRINT**. This action opens the **PRINT** dialog box.
- 4 On the **PRINT** dialog box, choose the printer to use from the dropdown list, select printing options, and then click **OK**.

### 3.4 [DH485 Port x]

General configuration information for the specified DH-485 port on the module

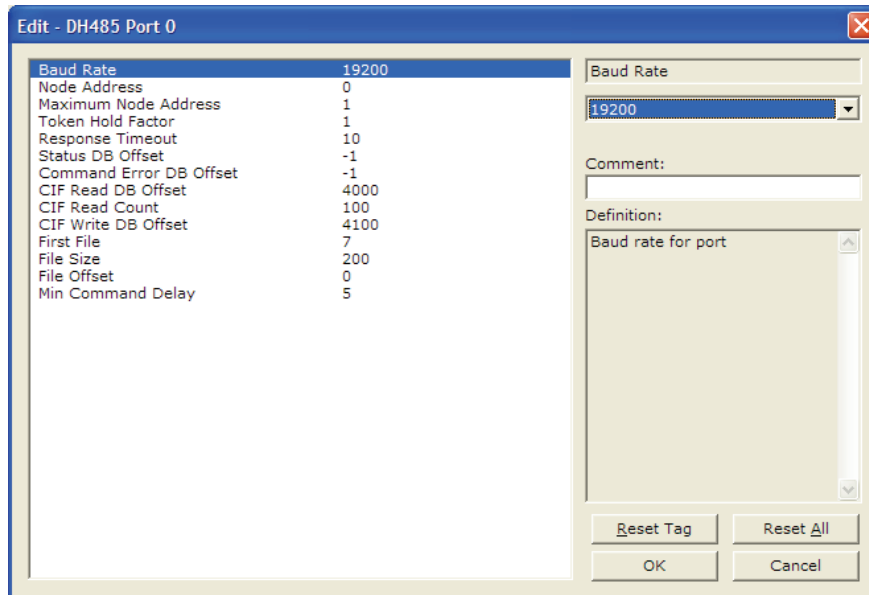

#### 3.4.1 Baud Rate

Range 1200 to 19200

This is the baud rate to use for the DH485 network. Select one of the listed baud rates.

#### 3.4.2 Node Address

Range 0 to 31

This is the node address to be utilized by the DH-485 driver for this port on the network. Enter a value not already used on the network in the range of 0 to 31. If a value of 255 is utilized or set by the module, the port is disabled. Note: All nodes on the network should be set to the lowest set of values in the range of 1 to 4).

#### 3.4.3 Maximum Node Address

Range 0 to 31

Enter the maximum address that the initiator searches for before wrapping to zero. The default is 31. This parameter should be set to the maximum node address set in the DH-485 network.

### **3.4.4 Token Hold Factor**

Range 0 to 31

Enter the number of transmissions (plus retries) that a node holding a token can send onto the data link each time that it receives the token. Enter a value between 0 and 31. The default is 1.

### **3.4.5 Response Timeout**

Range 1 to 50

This parameter sets the number of 100 millisecond time intervals to wait for a response to a request from the module. If the module does not receive the response within the time period specified, a timeout condition will be set for the command.

### **3.4.6 Status DB Offset**

Range -1 to 3980

This parameter sets the location of the status data for the port in the module's internal database. If the parameter is set to -1, the data is not placed in the database. If a valid value is entered, the module's status data will be placed in the database starting at the location indicated.

### **3.4.7 Command Error DB Offset**

Range -1 to 3900

This parameter sets the location of the command error list data for the port in the module's internal database. If the parameter is set to -1, the data is not placed in the database. If a valid value is entered, the module's error list data will be placed in the database starting at the location indicated.

### **3.4.8 CIF Read DB Offset**

Range -1 to 7500 (Only even values)

This parameter sets the starting byte location in the module's database where the CIF file Read will be placed. This data is passed from CIF memory area to the set location in the module's database. If this parameter is set to -1, no CIF read data will be utilized. When the CIF Read Area is disabled (CIF Read DB Offset = -1) or CIF Read Count = 0, the Debug menu shows this parameter as 65535.

### **3.4.9 CIF Read Count**

Range 0 to 242

This parameter sets the number of bytes to transfer from the CIF file to the database. The CIF write count will be calculated as (244 - CIF Read Count)

### **3.4.10 CIF Write DB Offset**

Range -1 to 7500 (Only even values)

This parameter sets the starting byte location in the module's database where the CIF file Write data will be read from. This data is passed to the CIF memory area from the set location in the module's database. If this parameter is set to -1, no CIF write data will be utilized. When the CIF Write Area is disabled (CIF Write DB Offset = -1) or CIF Write Count = 0, the Debug menu shows this parameter as 65535.

### **3.4.11 First File**

Range 0 to 255

This parameter sets the file number for the first file to be emulated by the module.

### **3.4.12 File Size**

Range 1 to 1000

This parameter sets the word size of all the files emulated in the module

### **3.4.13 File Offset**

Range 1 to 999

This parameter sets the word offset into the module's database where the file emulation will start.

### **3.4.14 Min Command Delay**

Range 0 to 10000

This parameter sets the minimum number of milliseconds to wait before issuing each command. This parameter is utilized to keep the network from being flooded with requests from the module.

### 3.5 [DH485 Port x Commands]

The [DH485 Port x Commands] section for each port defines the commands to be issued by the module to other devices on the network. These commands can be used for data collection and/or control.

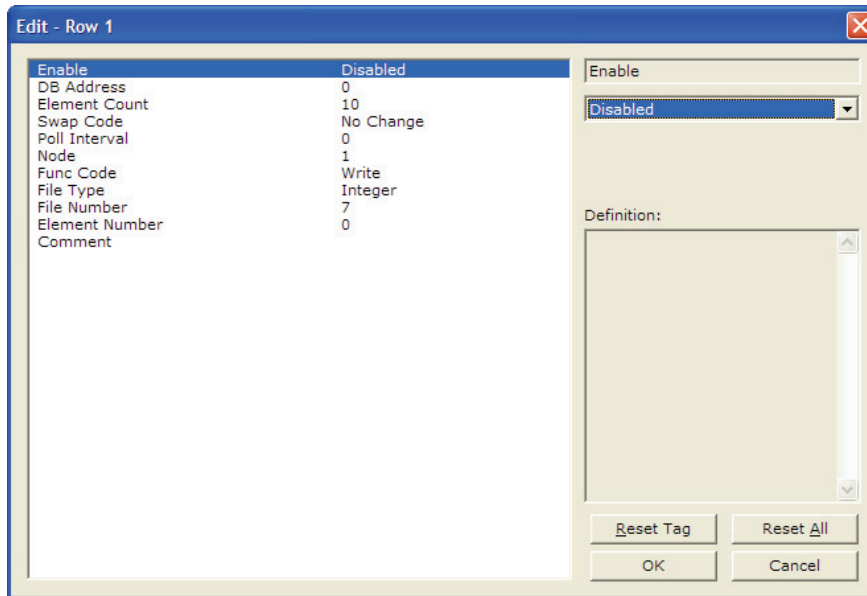

#### 3.5.1 Command List Overview

In order to interface the DH485 module to act as a master device, you must construct a command list for each port. The commands in the list specify the node to be addressed, the function to be performed (read or write), the data area in the device to interface with and the registers in the internal database to be associated with the device data. The command list supports up to 100 commands. The command list is processed from top (command #0) to bottom. A poll interval parameter is associated with each command to specify a minimum delay time in seconds between the issuance of a command. If the user specifies a value of 10 for the parameter, the command will be executed no more frequently than every 10 seconds.

Write commands have a special feature, as they can be set to execute only if the data in the write command changes. If the register data values in the command have not changed since the command was last issued, the command will not be executed. If the data in the command has changed since the command was last issued, the command will be executed. Use of this feature can lighten the load on the network. In order to implement this feature; set the enable code for the command to a value of 2.



### 3.5.2 Command Entry Format

Each command entered in the command list section has the same format. The following is an example section for Port 0:

	Enable	DB Address	Element Count	Swap Code	Poll Interval	Node	Func Code	File Type	File Number
✓ 1	Poll at interval	1000	10	No Change	0	6	Read	Integer	11
✓ 2	Poll at interval	1000	10	No Change	0	6	Write	Integer	10
✓ 3	Disabled	1000	100	No Change	0	5	Read	Integer	7
✓ 4	Disabled	1000	100	No Change	0	5	Write	Integer	16
✓ 5	Disabled	1500	10	No Change	0	6	Write	Integer	10
✓ 6	Disabled	1500	10	No Change	0	6	Read	Integer	11
✓ 7	Disabled	2260	10	No Change	0	6	Write	CIF	9
✓ 0	Disabled	2200	10	No Change	0	6	Read	CIF	9

Enable Value Status - OK

Buttons: Set to Defaults, Add Row, Insert Row, Delete Row, Move Up, Move Down, Edit Row, Copy Row, Paste Row, OK, Cancel

The first part of each record in the section relates to the module interface and the last part relates to the node to be interfaced with. The following topics describe each field required for a user command

#### 3.5.3 Enable Type Code

This field defines if the command is enabled and when it should be executed. The following codes are recognized by the application:

- 0 = Command is disabled
- 1 = Command is executed at the polling interval specified
- 2 = The write command is only executed when data changes

#### 3.5.4 Database Start Address

This field defines the starting address in the module's internal database to associate with the command. This field can have a value from 0 to 3999. The address supplied is a word address in the database.

#### 3.5.5 Element Count

This field defines the number of elements to be used with the command. If the command is interfacing with CIF data, this parameter represents a byte count. For data file access, the data size utilized depends on the file type used.

### 3.5.6 Swap Code

This field changes the order of the bytes and/or words used when sending or receiving the data. The following codes are utilized:

Swap Code	Description
0	None - No Change is made in the byte ordering (1234 = 1234)
1	Words - The words are swapped (1234=3412)
2	Words & Bytes - The words are swapped then the bytes in each word are swapped (1234=4321)
3	Bytes - The bytes in each word are swapped (1234=2143)

### 3.5.7 Poll Interval

This field sets the time interval between successive execution of the command. This parameter is specified in seconds. If the field is set to 10, the command will not be executed more frequently than every 10 seconds.

### 3.5.8 Node Number

This field defines the node address of the DH-485 node to send the command request. This field should be set to a value from 0 to 31.

### 3.5.9 Function Code

This field defines the function to be executed by the command. The module uses the following codes:

- 0 = Read
- 1 = Write

### 3.5.10 File Type

This field defines the file type to be interfaced with in the other DH-485 node. The program utilizes the following codes for this field:

- 0 = Status File (2 bytes per element)
- 1 = Bit File (2 bytes per element)
- 2 = Timer File (6 bytes per element)
- 3 = Counter File (6 bytes per element)
- 4 = Control File (6 bytes per element)
- 5 = Integer File (2 bytes per element)
- 6 = Floating-point File (4 bytes per element)
- 10 = CIF File (1 byte per element)

### 3.5.11 File Number

This field defines the file number to access. This field is ignored for CIF file access and should be set to 0. For Bit, Timer, Counter, Control, Integer, and Float data types, a maximum value of 255 is valid.

### 3.5.12 Element Number

This field defines the first element in the file specified to be associated with the command. For a CIF file, this parameter is given as the byte location. For Bit, Timer, Counter, Control, Integer, and Float data types, the maximum value is 255. For CIF data types the maximum value is 510.

#### Maximum Element Counts for Read/Write Commands

The maximum number of elements requested from a remote node is determined by the file type and function code utilized in the command. The following table lists the maximum element count for each file type:

File Type	Bytes/Elements	Read Result	Write Result
Status	2	83	83
Bit	2	118	115
Timer	6	39	38
Counter	6	39	38
Control	6	39	38
Integer	2	118	115
Float	4	59	57
CIF	1	236	234

## 3.6 [DH485 Port x Maps]

**Note:** This section applies only when the DH485 module is operating in Slave mode.

Each file map entered in the configuration file has the same format. The following is an example section for Port 0:

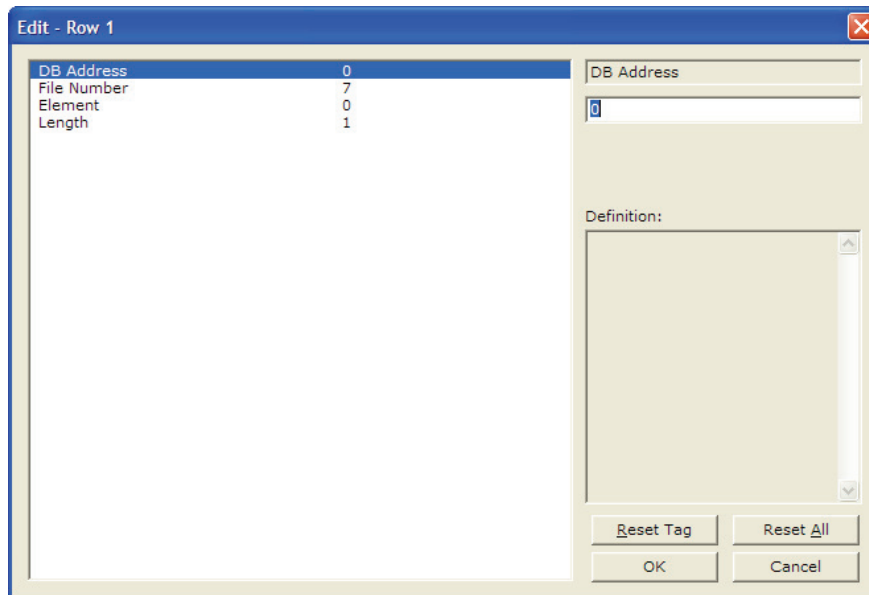

These file maps are searched first when a node on the network makes a request. If the requested data area is found in the map list, the database area associated

with the command will be used. If the requested data area is not found in the map list, the fixed mapping data configuration will be used.

The following topics describe each field required for an override map.

### 3.6.1 DB Address

This field defines the starting address in the module's database for the file emulation. This parameter can be assigned a value of 0 to 3999.

### 3.6.2 File Number

This field defines the file number to be emulated at the specified database location.

### 3.6.3 Element

This field specifies the first element in the file to be emulated. This element number corresponds to the database start address set for the record.

### 3.6.4 Word Count (Length)

This field defines the number of word registers to be emulated in the file.

## 3.7 Downloading a File from PC to the Module

- 1 Verify that your PC is connected to the gateway with a null-modem serial cable connected to the serial port on your PC and the serial port on the gateway
- 2 Open the **PROJECT** menu, and then choose **MODULE**.
- 3 On the **MODULE** menu, choose **DOWNLOAD**. Wait while ProSoft Configuration scans for communication ports on your PC. When the scan is complete, the **DOWNLOAD** dialog box opens.

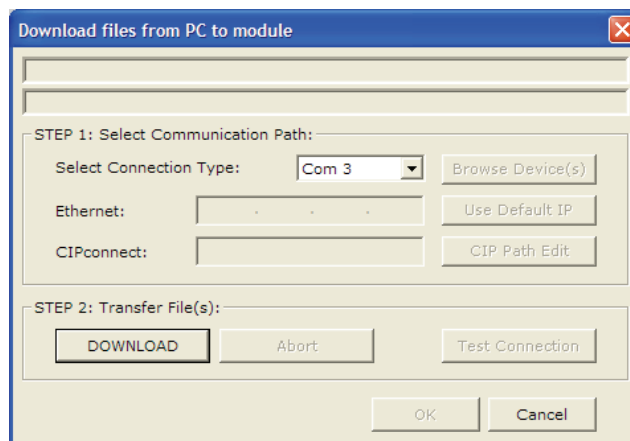

- 4 Select the port to use for the download.
- 5 Click the **DOWNLOAD** button.

## 4 Serial Port Protocol Error/Status Data

### *In This Chapter*

- ❖ Viewing Error and Status Data ..... 29
- ❖ DH485 Error and Status Data Area Addresses ..... 29

The second and most thorough troubleshooting method for debugging the operation of the DH-485 driver (and the module in general), is the powerful Debug port on the module which provides much more complete access to the internal operation and status of the module. Accessing the Debug capabilities of the module is accomplished easily by connecting a PC to the Debug port and loading a terminal program such as ProSoft Configuration Builder or Hyperterminal.

### 4.1 Viewing Error and Status Data

The following topics describe the register addresses that contain protocol error and status data. Viewing the contents of each register is accomplished using the Database View option. The use of this option and its associated features are described in detail in the ProLinX Reference Guide.

### 4.2 DH485 Error and Status Data Area Addresses

#### DH485 Status Data Area

Byte #	Description
0 to 3	Active node bits for stations 0 to 31
4 to 5	Online status (0=Offline, 1=Online)
6 to 7	Node address of the unit/port emulated
8 to 9	Current command index being issued
10 to 11	Total number of request messages
12 to 13	Total number of response messages received
14 to 15	Total number of command list errors
16 to 17	Configuration error word. Each bit represent a configuration error condition.
18 to 19	Reserved for future use.
20 to 21	Total number of packets received
22 to 23	Total number of packets transmitted
24	Total retry count
25	Retry failure counter
26	Total number of NAK's because of no memory for reception

Byte #	Description
27	Total number of NAK's because of no memory for transmission
28	Total number of bad packets
29	Total number of bad control packets
30	Total number of packets received with a bad CRC value
31	Total number of parity errors
32	Total number of framing errors
33	Total number of overrun errors
34	Total number of unexpected bytes received
35	Total number of bad LSAP's received

Word#	Description
0	Error code for command index 0.
1	Error code for command index 1.
---	---
99	Error code for command index 99.

#### 4.2.1 DH485 General Error Codes

Error #	Description
0	Operation successful
1	Invalid parameter
2	Device is already open
3	Device is not present
4	Invalid access
5	The function has timed out
6	
7	Unable to configure the requested port
8	Unable to allocate memory for DH-485 driver

#### 4.2.2 DH485 API Specific Error Codes

Error #	Description
0x0800	Command only permitted in master mode
0x0801	Command already active on the port
0x0802	Response to request timed out
0x0803	Unable to allocate memory for the request
0x0804	Illegal command or format
0x0805	Host could not complete request (hardware fault)
0x0806	Out of memory, file or rung does not exist
0x0807	Field has an illegal value
0x0808	Not enough fields in request message

<b>Error #</b>	<b>Description</b>
0x0809	Too many fields in request message
0x080A	Symbol not found
0x080B	Symbol 0 or greater than maximum characters permitted in message
0x080C	Does not exist, illegal size
0x080D	File wrong size, address past end of file
0x080E	Data or file too large (memory not available)
0x080F	Request too large to transmit message (size+address > max message)
0x0810	Access denied
0x0811	Command cannot be executed
0x0812	Illegal data type information
0x0813	Illegal parameter, invalid data in search or command block
0x0814	File open by another node
0x0815	Program owned by another node
0x0816	Unknown error returned from host
0x0817	No message active on the port

### **4.2.3 DH485 Configuration Error Word**

<b>Bit</b>	<b>Code</b>	<b>Description</b>
0	0x0001	Invalid baud rate
1	0x0002	Invalid node address
2	0x0004	Invalid maximum node address
3	0x0008	Invalid token hold factor
4	0x0010	Invalid response timeout
5	0x0020	Invalid status or command error DB offset
6	0x0040	Invalid CIF read count or DB offset
7	0x0080	Invalid CIF write DB offset
8	0x0100	Invalid file size
9	0x0200	Invalid file offset
10	0x0400	
11	0x0800	
12	0x1000	
13	0x2000	
14	0x4000	
15	0x8000	





## 5 Reference

### *In This Chapter*

❖ Status Data Area .....	33
❖ Command Error List Data Area .....	34
❖ RS-232 .....	34
❖ RS-485 .....	34

### 5.1 Status Data Area

Offset	Description
14100	Active node bits for stations 0 to 15
14101	Active node bits for stations 16 to 31
14102	Online status (0=Offline, 1=Online)
14103	Node address of the unit/port emulated
14104	Current command index being issued
14105	Total number of request messages
14106	Total number of response messages received
14107	Total number of command list errors
14108	Configuration error word. Each bit represent a configuration error condition.
14109	Reserved for future use.
14110	Total number of packets received
14111	Total number of packets transmitted
14112(1)	Total retry count
14112(2)	Retry failure counter
14113(1)	Total number of NAK's because of no memory for reception
14113(2)	Total number of NAK's because of no memory for transmission
14114(1)	Total number of bad packets
14114(2)	Total number of bad control packets
14115(1)	Total number of packets received with a bad CRC value
14115(2)	Total number of parity errors
14116(1)	Total number of framing errors
14116(2)	Total number of overrun errors
14117(1)	Total number of unexpected bytes received
14117(2)	Total number of bad LSAP's received

(1) = First byte of the word

(2) = Second byte of the word

## 5.2 Command Error List Data Area

Word#	Description
14200	Error code for command index 0.
14201	Error code for command index 1.
...	...
14299	Error code for command index 99.

## 5.3 RS-232

When the RS-232 interface is selected, you must use an AIC+ to connect the port to a DH485. The cable required for this connection is shown in the following illustration:

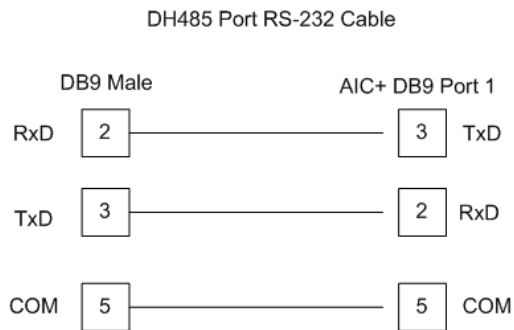

## 5.4 RS-485

The RS-485 uses a single two or three wire cable. The use of the ground is optional and dependent on the RS-485 network. The cable required for this interface is shown in the following diagram:

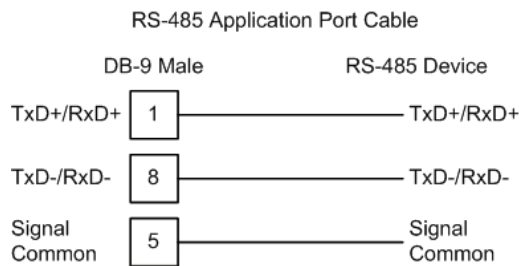

When connecting to port 3 of an AIC+ module, the following is the correct wiring:

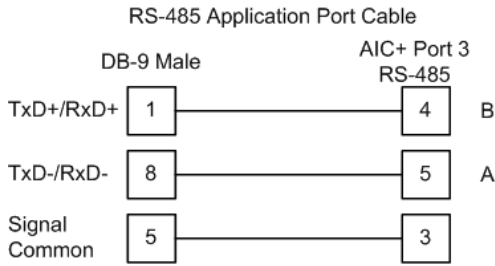

When connecting to a 1747-AIC module, the following is the correct wiring:

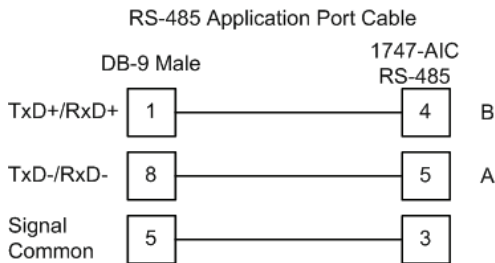

The following illustration shows an example DH-485 network.

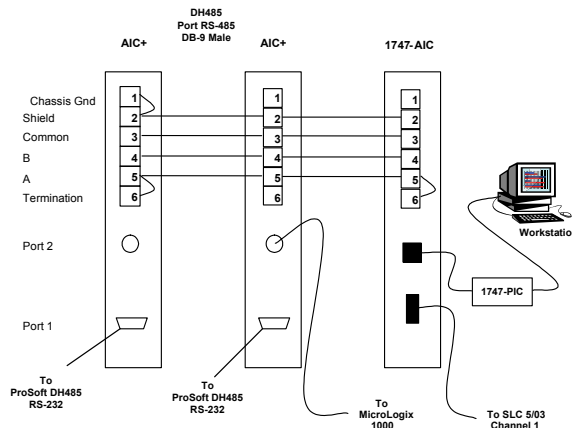

This network displays the two different methods to configure the module for a DH-485 network. Please note there is no place on the module's RS-485 to land the shield, and when used in the configuration shown, it must be wired externally. Verify that the RS interface jumper on the module is set to the correct position: RS-232 or RS-485.

**Note:** Terminating resistors are generally not required on the RS-485 network, unless you are experiencing communication problems that can be attributed to signal echoes or reflections. In this case, install a 120 ohm terminating resistor on the RS-485 line.





## 6.2 Return Material Authorization (RMA) Policies and Conditions

The following RMA Policies and Conditions (collectively, "RMA Policies") apply to any returned Product. These RMA Policies are subject to change by ProSoft without notice. For warranty information, see "Limited Warranty". In the event of any inconsistency between the RMA Policies and the Warranty, the Warranty shall govern.

### 6.2.1 All Product Returns:

- a) In order to return a Product for repair, exchange or otherwise, the Customer must obtain a Returned Material Authorization (RMA) number from ProSoft and comply with ProSoft shipping instructions.
- b) In the event that the Customer experiences a problem with the Product for any reason, Customer should contact ProSoft Technical Support at one of the telephone numbers listed above (page 37). A Technical Support Engineer will request that you perform several tests in an attempt to isolate the problem. If after completing these tests, the Product is found to be the source of the problem, we will issue an RMA.
- c) All returned Products must be shipped freight prepaid, in the original shipping container or equivalent, to the location specified by ProSoft, and be accompanied by proof of purchase and receipt date. The RMA number is to be prominently marked on the outside of the shipping box. Customer agrees to insure the Product or assume the risk of loss or damage in transit. Products shipped to ProSoft using a shipment method other than that specified by ProSoft or shipped without an RMA number will be returned to the Customer, freight collect. Contact ProSoft Technical Support for further information.
- d) A 10% restocking fee applies to all warranty credit returns whereby a Customer has an application change, ordered too many, does not need, and so on.

### 6.2.2 Procedures for Return of Units Under Warranty:

A Technical Support Engineer must approve the return of Product under ProSoft's Warranty:

- a) A replacement module will be shipped and invoiced. A purchase order will be required.
- b) Credit for a product under warranty will be issued upon receipt of authorized product by ProSoft at designated location referenced on the Return Material Authorization.

### 6.2.3 Procedures for Return of Units Out of Warranty:

- a) Customer sends unit in for evaluation
- b) If no defect is found, Customer will be charged the equivalent of \$100 USD, plus freight charges, duties and taxes as applicable. A new purchase order will be required.

- c) If unit is repaired, charge to Customer will be 30% of current list price (USD) plus freight charges, duties and taxes as applicable. A new purchase order will be required or authorization to use the purchase order submitted for evaluation fee.

The following is a list of non-repairable units:

- 3150 - All
- 3750
- 3600 - All
- 3700
- 3170 - All
- 3250
- 1560 - Can be repaired, only if defect is the power supply
- 1550 - Can be repaired, only if defect is the power supply
- 3350
- 3300
- 1500 - All

## 6.3 LIMITED WARRANTY

This Limited Warranty ("Warranty") governs all sales of hardware, software and other products (collectively, "Product") manufactured and/or offered for sale by ProSoft, and all related services provided by ProSoft, including maintenance, repair, warranty exchange, and service programs (collectively, "Services"). By purchasing or using the Product or Services, the individual or entity purchasing or using the Product or Services ("Customer") agrees to all of the terms and provisions (collectively, the "Terms") of this Limited Warranty. All sales of software or other intellectual property are, in addition, subject to any license agreement accompanying such software or other intellectual property.

### 6.3.1 *What Is Covered By This Warranty*

- a) *Warranty On New Products:* ProSoft warrants, to the original purchaser, that the Product that is the subject of the sale will (1) conform to and perform in accordance with published specifications prepared, approved and issued by ProSoft, and (2) will be free from defects in material or workmanship; provided these warranties only cover Product that is sold as new. This Warranty expires three years from the date of shipment (the "Warranty Period"). If the Customer discovers within the Warranty Period a failure of the Product to conform to specifications, or a defect in material or workmanship of the Product, the Customer must promptly notify ProSoft by fax, email or telephone. In no event may that notification be received by ProSoft later than 39 months. Within a reasonable time after notification, ProSoft will correct any failure of the Product to conform to specifications or any defect in material or workmanship of the Product, with either new or used replacement parts. Such repair, including both parts and labor, will be performed at ProSoft's expense. All warranty service will be performed at service centers designated by ProSoft.

- b) *Warranty On Services:* Materials and labor performed by ProSoft to repair a verified malfunction or defect are warranted in the terms specified above for new Product, provided said warranty will be for the period remaining on the original new equipment warranty or, if the original warranty is no longer in effect, for a period of 90 days from the date of repair.

### **6.3.2 What Is Not Covered By This Warranty**

- a) ProSoft makes no representation or warranty, expressed or implied, that the operation of software purchased from ProSoft will be uninterrupted or error free or that the functions contained in the software will meet or satisfy the purchaser's intended use or requirements; the Customer assumes complete responsibility for decisions made or actions taken based on information obtained using ProSoft software.
- b) This Warranty does not cover the failure of the Product to perform specified functions, or any other non-conformance, defects, losses or damages caused by or attributable to any of the following: (i) shipping; (ii) improper installation or other failure of Customer to adhere to ProSoft's specifications or instructions; (iii) unauthorized repair or maintenance; (iv) attachments, equipment, options, parts, software, or user-created programming (including, but not limited to, programs developed with any IEC 61131-3, "C" or any variant of "C" programming languages) not furnished by ProSoft; (v) use of the Product for purposes other than those for which it was designed; (vi) any other abuse, misapplication, neglect or misuse by the Customer; (vii) accident, improper testing or causes external to the Product such as, but not limited to, exposure to extremes of temperature or humidity, power failure or power surges; or (viii) disasters such as fire, flood, earthquake, wind and lightning.
- c) The information in this Agreement is subject to change without notice. ProSoft shall not be liable for technical or editorial errors or omissions made herein; nor for incidental or consequential damages resulting from the furnishing, performance or use of this material. The user guide included with your original product purchase from ProSoft contains information protected by copyright. No part of the guide may be duplicated or reproduced in any form without prior written consent from ProSoft.

### **6.3.3 Disclaimer Regarding High Risk Activities**

Product manufactured or supplied by ProSoft is not fault tolerant and is not designed, manufactured or intended for use in hazardous environments requiring fail-safe performance including and without limitation: the operation of nuclear facilities, aircraft navigation or communication systems, air traffic control, direct life support machines or weapons systems in which the failure of the product could lead directly or indirectly to death, personal injury or severe physical or environmental damage (collectively, "high risk activities"). ProSoft specifically disclaims any express or implied warranty of fitness for high risk activities.



### **6.3.4 Intellectual Property Indemnity**

Buyer shall indemnify and hold harmless ProSoft and its employees from and against all liabilities, losses, claims, costs and expenses (including attorney's fees and expenses) related to any claim, investigation, litigation or proceeding (whether or not ProSoft is a party) which arises or is alleged to arise from Buyer's acts or omissions under these Terms or in any way with respect to the Products. Without limiting the foregoing, Buyer (at its own expense) shall indemnify and hold harmless ProSoft and defend or settle any action brought against such Companies to the extent based on a claim that any Product made to Buyer specifications infringed intellectual property rights of another party. ProSoft makes no warranty that the product is or will be delivered free of any person's claiming of patent, trademark, or similar infringement. The Buyer assumes all risks (including the risk of suit) that the product or any use of the product will infringe existing or subsequently issued patents, trademarks, or copyrights.

- a) Any documentation included with Product purchased from ProSoft is protected by copyright and may not be duplicated or reproduced in any form without prior written consent from ProSoft.
- b) ProSoft's technical specifications and documentation that are included with the Product are subject to editing and modification without notice.
- c) Transfer of title shall not operate to convey to Customer any right to make, or have made, any Product supplied by ProSoft.
- d) Customer is granted no right or license to use any software or other intellectual property in any manner or for any purpose not expressly permitted by any license agreement accompanying such software or other intellectual property.
- e) Customer agrees that it shall not, and shall not authorize others to, copy software provided by ProSoft (except as expressly permitted in any license agreement accompanying such software); transfer software to a third party separately from the Product; modify, alter, translate, decode, decompile, disassemble, reverse-engineer or otherwise attempt to derive the source code of the software or create derivative works based on the software; export the software or underlying technology in contravention of applicable US and international export laws and regulations; or use the software other than as authorized in connection with use of Product.
- f) **Additional Restrictions Relating To Software And Other Intellectual Property**

In addition to compliance with the Terms of this Warranty, Customers purchasing software or other intellectual property shall comply with any license agreement accompanying such software or other intellectual property. Failure to do so may void this Warranty with respect to such software and/or other intellectual property.

### **6.3.5 Disclaimer of all Other Warranties**

The Warranty set forth in What Is Covered By This Warranty (page 39) are in lieu of all other warranties, express or implied, including but not limited to the implied warranties of merchantability and fitness for a particular purpose.

### **6.3.6 Limitation of Remedies \*\***

In no event will ProSoft or its Dealer be liable for any special, incidental or consequential damages based on breach of warranty, breach of contract, negligence, strict tort or any other legal theory. Damages that ProSoft or its Dealer will not be responsible for included, but are not limited to: Loss of profits; loss of savings or revenue; loss of use of the product or any associated equipment; loss of data; cost of capital; cost of any substitute equipment, facilities, or services; downtime; the claims of third parties including, customers of the Purchaser; and, injury to property.

\*\* Some areas do not allow time limitations on an implied warranty, or allow the exclusion or limitation of incidental or consequential damages. In such areas, the above limitations may not apply. This Warranty gives you specific legal rights, and you may also have other rights which vary from place to place.

### **6.3.7 Time Limit for Bringing Suit**

Any action for breach of warranty must be commenced within 39 months following shipment of the Product.

### **6.3.8 No Other Warranties**

Unless modified in writing and signed by both parties, this Warranty is understood to be the complete and exclusive agreement between the parties, suspending all oral or written prior agreements and all other communications between the parties relating to the subject matter of this Warranty, including statements made by salesperson. No employee of ProSoft or any other party is authorized to make any warranty in addition to those made in this Warranty. The Customer is warned, therefore, to check this Warranty carefully to see that it correctly reflects those terms that are important to the Customer.

### **6.3.9 Allocation of Risks**

This Warranty allocates the risk of product failure between ProSoft and the Customer. This allocation is recognized by both parties and is reflected in the price of the goods. The Customer acknowledges that it has read this Warranty, understands it, and is bound by its Terms.

### **6.3.10 Controlling Law and Severability**

This Warranty shall be governed by and construed in accordance with the laws of the United States and the domestic laws of the State of California, without reference to its conflicts of law provisions. If for any reason a court of competent jurisdiction finds any provisions of this Warranty, or a portion thereof, to be unenforceable, that provision shall be enforced to the maximum extent permissible and the remainder of this Warranty shall remain in full force and effect. Any cause of action with respect to the Product or Services must be instituted in a court of competent jurisdiction in the State of California.

# Index

## I

[DH485 Port x Commands] • 24  
[DH485 Port x Maps] • 27  
[DH485 Port x] • 21

## A

All Product Returns • 38  
All ProLinX® Products • 2  
Allocation of Risks • 42

## B

Baud Rate • 21

## C

CIF Read Count • 22  
CIF Read DB Offset • 22  
CIF Write DB Offset • 23  
Command Entry Format • 25  
Command Error DB Offset • 22  
Command Error List Data Area • 34  
Command List Overview • 24  
Comment Entries • 20  
Configure the Module • 17  
Configuring Module Parameters • 19  
Connecting Power to the Unit • 9  
Controlling Law and Severability • 42

## D

Database Start Address • 25  
DB Address • 28  
DH485 API Specific Error Codes • 30  
DH-485 CIF Information • 13  
DH485 Configuration Error Word • 31  
DH485 Error and Status Data Area Addresses • 29  
DH485 General Error Codes • 30  
DH485 Serial Port Driver Access to Database • 12  
Disclaimer of all Other Warranties • 41  
Disclaimer Regarding High Risk Activities • 40  
Downloading a File from PC to the Module • 28

## E

Element • 28  
Element Count • 25  
Element Number • 27  
Enable Type Code • 25

## F

File Number • 26, 28  
File Offset • 23  
File Size • 23

File Type • 26  
First File • 23  
Function Code • 26  
Functional Overview • 11  
Functional Specifications - DH-485 • 15

## G

General Specifications • 15

## H

Hardware Specifications • 16  
How to Contact Us  
    Technical Support • 37, 38

## I

Important Installation Instructions • 2  
Install ProSoft Configuration Builder Software • 9  
Intellectual Property Indemnity • 41

## L

Limitation of Remedies \*\* • 42  
LIMITED WARRANTY • 39

## M

Master/Slave Serial Port • 11  
Maximum Element Counts for Read/Write Commands  
    • 27  
Maximum Node Address • 21  
Min Command Delay • 23  
Module Internal Database • 11  
Mounting the module on the DIN-rail • 8

## N

No Other Warranties • 42  
Node Address • 21  
Node Number • 26

## P

Package Contents • 8  
Pinouts • 2, 34  
Poll Interval • 26  
Printing a Configuration File • 20  
Procedures for Return of Units Out of Warranty: • 38  
Procedures for Return of Units Under Warranty: • 38  
ProLinX Gateways with Ethernet Ports • 2  
ProSoft Technology® Product Documentation • 3  
Protocol Functional Specifications • 15

## R

Reference • 33  
Response Timeout • 22  
Return Material Authorization (RMA) Policies and  
    Conditions • 38  
RS-232 • 34  
RS-485 • 34

## **S**

- Serial Port Protocol Error/Status Data • 29
- Start Here • 7
- Status Data Area • 33
- Status DB Offset • 22
- Support, Service & Warranty • 37
- Swap Code • 26
- System Requirements • 7

## **T**

- Time Limit for Bringing Suit • 42
- To Order a ProLinX Plus gateway with the -WEB option: • 3
- To upgrade a previously purchased Series C model: • 2
- Token Hold Factor • 22

## **U**

- Using the Help System • 10

## **V**

- Viewing Error and Status Data • 29

## **W**

- What Is Covered By This Warranty • 39, 41
- What Is Not Covered By This Warranty • 40
- Word Count (Length) • 28

## **Y**

- Your Feedback Please • 3