



SlotServer Supplement

LonWorks Open Profile

APPLICABILITY & EFFECTIVITY

This manual is a supplement to the SlotServer Startup Guide and Configuration Manual and provides instructions for the following FieldServer products:

	<u>Description</u>
PS56-LON-000	FieldServer

Effective for all systems manufactured after January 2011

Kernel Version:	5.21
Document Revision:	1

TABLE OF CONTENTS

1	Introduction	3
1.1	About this product	3
1.2	About LonWorks and Profiling	3
1.3	Connection Capability	3
2	Pre-Startup checklist	4
2.1	Accessories supplied with the SlotServer	4
2.2	Third party components (not supplied by FieldServer Technologies)	4
2.3	Required configuration for the SlotServer	4
3	SlotServer Topology	5
3.1	Hardware Connection Tips / Hints	5
4	Commissioning the Open Profile on the SlotServer	6
4.1	Write Ladder Program to Get LonWorks Input Data	6
4.2	Write Ladder Program to Send LonWorks Output Data	8
4.3	Download the RSLogix Program and Run	9
4.4	Bind LonWorks Variables	9
4.5	Interpret the Network Variable Data	9
5	Accessing All LonWorks Function Block Data	11
5.1	Input Data from Function Blocks In[1] to In[24]	11
5.2	Output Data from Function Blocks Out[1] to Out[24]	11
5.3	Optimizing performance for smaller applications	12
	Appendix A. Troubleshooting	13
	Appendix A.1. Things to check when communications has failed	13
	Appendix B. Vendor Information	14
	Appendix B.1. Using LonMaker to Commission a SlotServer	14
	Appendix C. Reference	15
	Appendix C.1. Network Variables List – SlotServer LonWorks Open Profile	15
	Appendix C.2. Other Resources	16

1 INTRODUCTION

1.1 About this product

The SlotServer Start-Up Guide covers information for installing the SlotServer. Depending on the SlotServer Module ordered, supplementary Driver manuals provide information on how to configure the third party protocols residing in the SlotServer.

The SlotServer Configuration Manual provides the information necessary to configure the SlotServer, allowing an Allen Bradley ControlLogix platform to pass data between a ControlLogix CPU and other third party communications protocols supported by the SlotServer.

This manual is a supplement to the general Configuration Manual and describes the parameters needed for LonWorks configuration as well as the Open Profile supplied with this product.

1.2 About LonWorks[™] and Profiling

Inherent to the design of LonWorks is the intention that all nodes residing on a LonWorks network possess a profile which accurately describes the network variables available to the LonWorks network. This profile is declared to the LonWorks network by means of an External Interface File (XIF). This XIF remains unchanged for any particular profile. In other words, a change in the XIF is by definition a new profile.

The SlotServer LonWorks Open Profile provides a generic list of SNVT's that can be used to bind the most common LonWorks data types to the SlotServer for data transfer. This document describes this fixed Open Interface profile for the SlotServer. Note that as a LonMark compatible product, the SlotServer platform is also capable of supporting other profiles. For further information, please contact FieldServer Technologies.

1.3 Connection Capability

SlotServer Mode	LonWorks Nodes	Comments
Implicit	15	As an implicitly bound object in LonWorks, the LonWorks protocol supports the binding of active variables in this device to a maximum of 15 other Nodes.

[™] LonWorks is a trademark of Echelon Corporation registered in the United States and other countries

2 PRE-STARTUP CHECKLIST

2.1 Accessories supplied with the SlotServer

Refer to the SlotServer Start-up Guide.

The required XIF file is located on the supplied USB drive in the Property Files folder.

There are 2 ACD files, one for the simple example, and one for the Multiplexing example on the supplied USB drive in the Property Files folder .

2.2 Third party components (not supplied by FieldServer Technologies)

The following minimum componentry is required to achieve a LonWorks/ControlLogix integration.

- LonWorks NetWork Manager (e.g: LonMaker)
- LonWorks Network components.

2.3 Required configuration for the SlotServer

In order to achieve data transfer between CPU tags and LonWorks network variables, the SlotServer will need to be commissioned into a LonWorks network using a LonWorks Network Manager. Once commissioned and bound, data from the LonWorks network is accessed by I/O image transfer in the ControlLogix CPU.

3 SLOTSERVER TOPOLOGY

The diagram below shows a typical implementation of the SlotServer LonWorks Open Profile

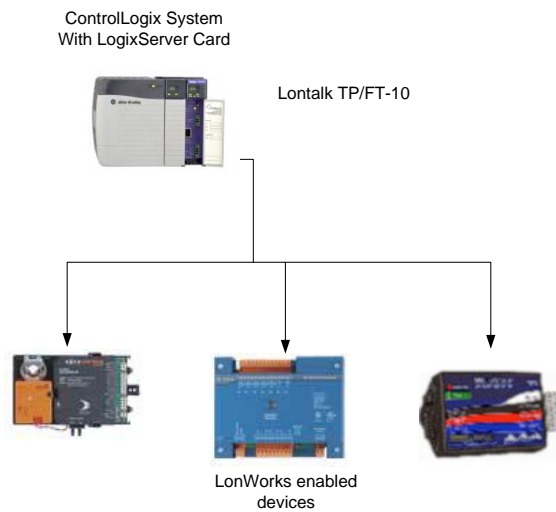

3.1 Hardware Connection Tips / Hints

The LonWorks TP/FT-10 medium is polarity insensitive and does not require attention to connection orientation on the pins.

4 COMMISSIONING THE OPEN PROFILE ON THE SLOTSERVER

The following steps are necessary to connect LonWorks Data to the PLC CPU via the SlotServer.

4.1 Write Ladder Program to Get LonWorks Input Data

- Add a CPS (Synchronous Copy File) Ladder element to synchronize the incoming Data from the LonWorks network. Use the Input Image Data as Source.

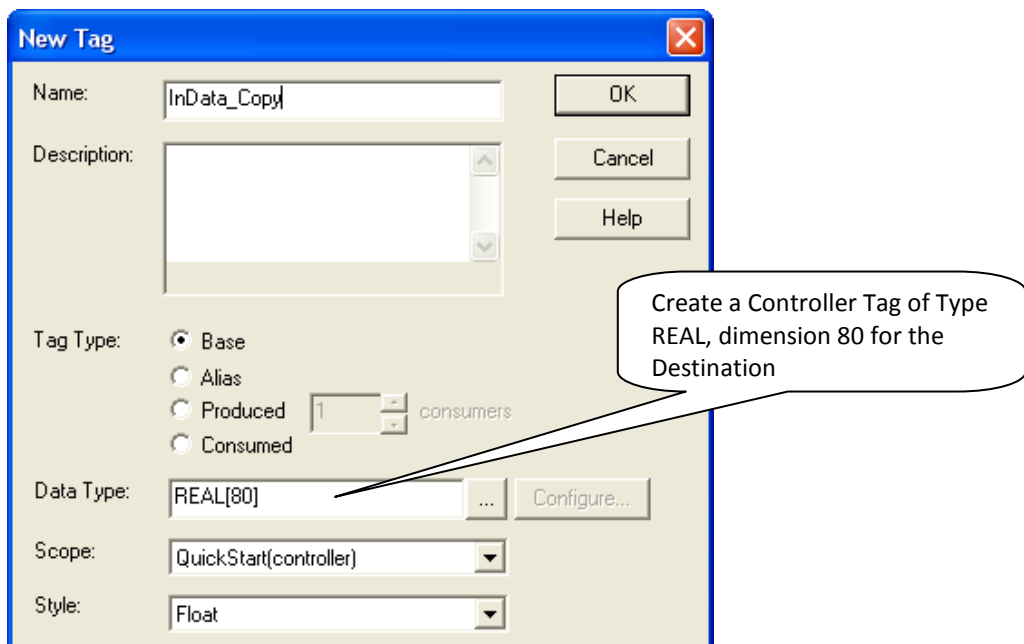
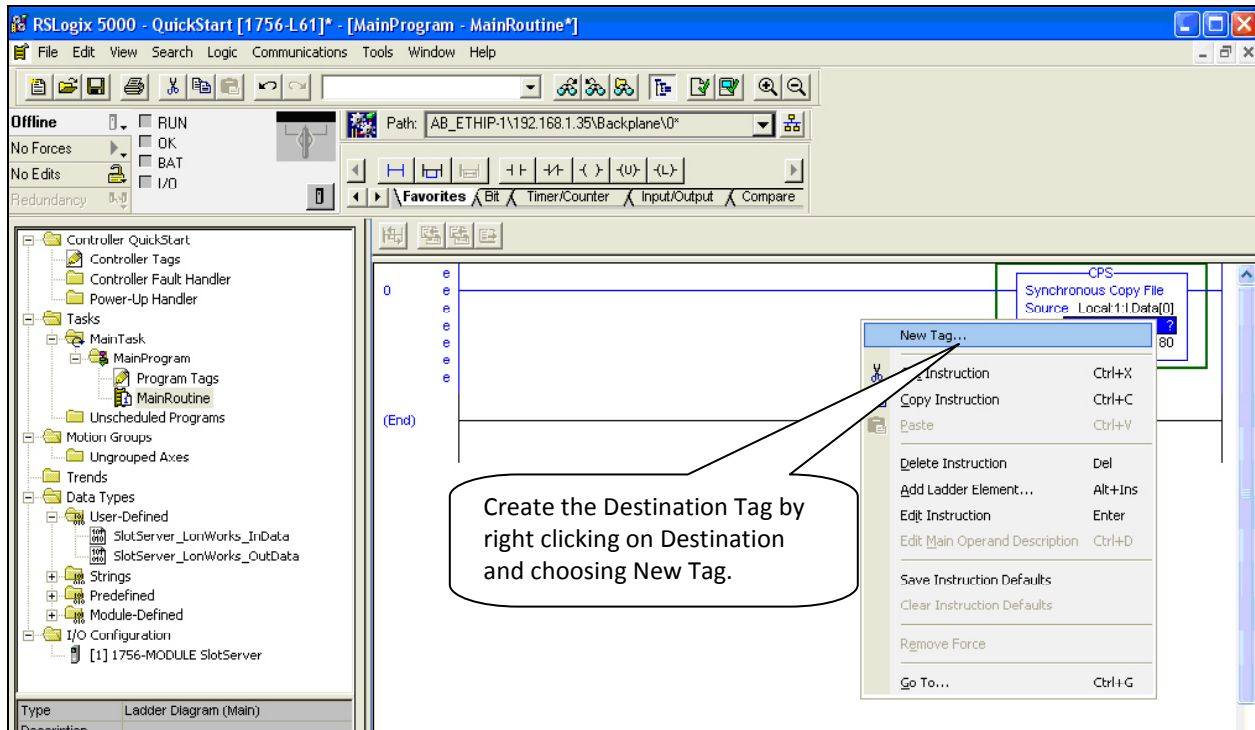

- Add an EQU (Compare if equal) ladder element to check when the first LonWorks data block has been received. The block number is at offset 2 of the input image.
- Finally, add another CPS ladder element to copy the LonWorks Data from the InData_Copy Tag to a new Controller Tag, called Lon_In_01. Also create the Tag by right clicking on Destination and choosing New Tag. The New Tag must be of type REAL and a dimension of 76.

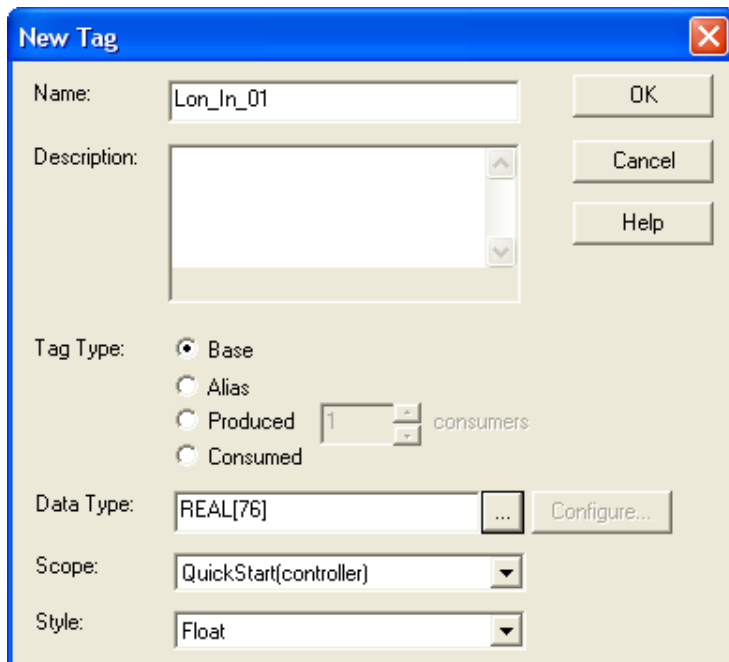
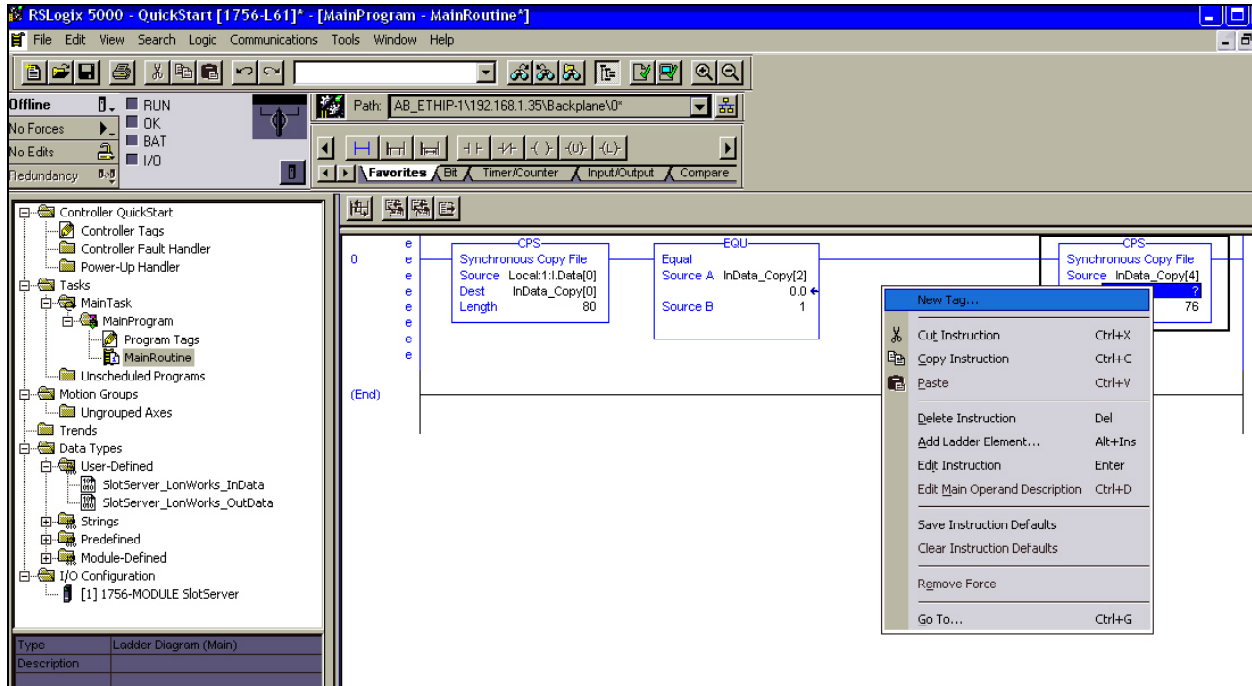

The final ladder program to access data from LonWorks Function Block In[0] is depicted below

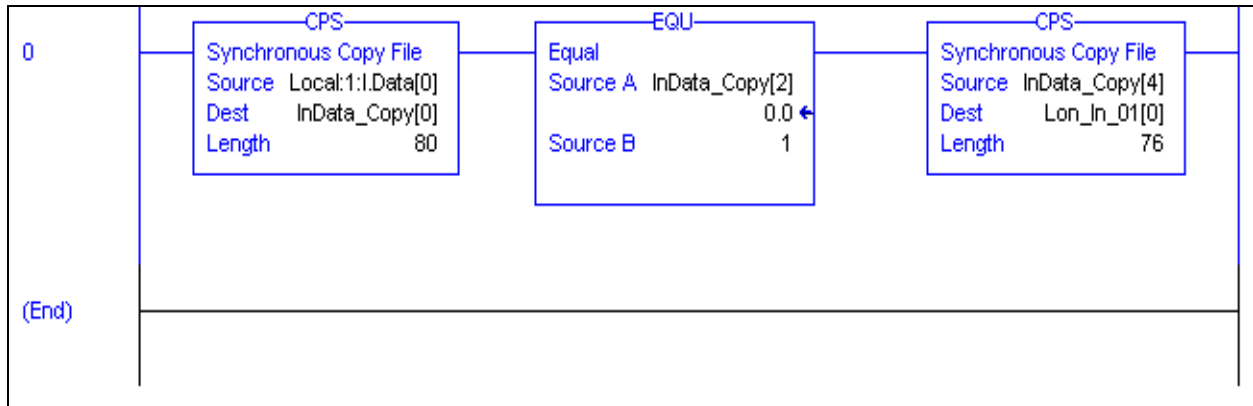

Very Important Note!

To ensure that the input data is from a specific LonWorks Function Block, make a synchronous copy of the input image data before using it.

4.2 Write Ladder Program to Send LonWorks Output Data

This step is only necessary if you need to write data to the LonWorks Network on Function Block Out[0]

- Create a Controller Tag called Lon_Out_01 of type REAL[80].
- Add a new rung to the Ladder program and add a MOV element to move a block number value of 1 into Lon_Out_01[2].
- Finally add a CPS (Synchronous Copy File) element to copy the full Lon_Out_01 tag into the Output Image Tag.

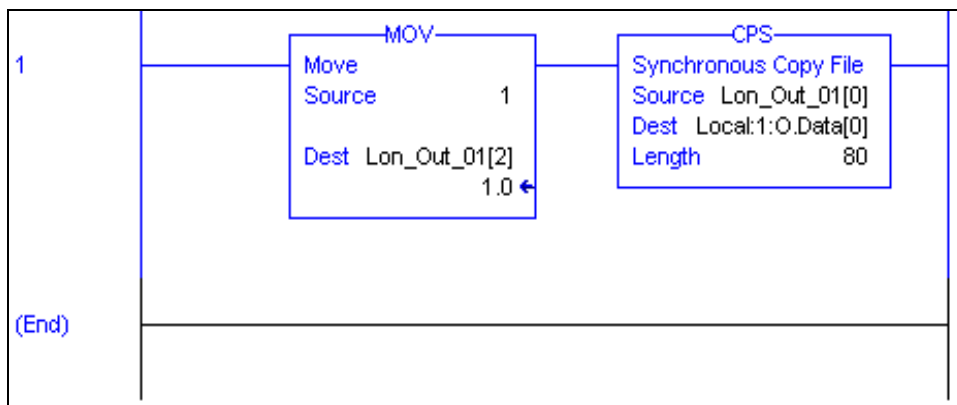

The LonWorks Data are present from Lon_Out_01[4] to Lon_Out_01[79]

A User Defined Data Type can be created to replace the type of Lon_Out_01 mapping the points to LonWorks point names.

Very Important Note!

All Output Image Tag data must be updated once using a Synchronous File Copy element. Attempting to update the block number into the Output Image Tag followed by the data will cause an asynchronous transfer of data.

4.3 Download the RSLogix Program and Run

Use the Who Active or Communications Path directly to Download and Run the Program on the Controller / CPU.

4.4 Bind LonWorks Variables

The SlotServer's LonWorks Network Variables must be bound to other devices using a Network Management Tool e.g. LonMaker. See Appendix B for more details on the use of a Network Management Tool to make the bindings.

4.5 Interpret the Network Variable Data

LonWorks Input Variable Values can be found in the Lon_In_01 Tag.

Offset	Network Variable Name	SNVT_Type
0	nviAmp1	SNVT_amp
1	nviAmp2	SNVT_amp
2 - 4	nviChlr1	SNVT_chlr_status
5	nviCount1	SNVT_count_f
6	nviCount2	SNVT_count_f
7	nviCtInc1	SNVT_count_inc_f
8	nviCtInc2	SNVT_count_inc_f
9	nviFlow1	SNVT_flow_f
10	nviFreq1	SNVT_freq_hz
11	nviHVMod1	SNVT_hvac_mode
12 - 18	nviHVSts1	SNVT_hvac_status
19	nviLev1	SNVT_lev_cont
20 - 21	nviObj1	SNVT_obj_status
22	nviOcc1	SNVT_occupancy
23	nviOcc2	SNVT_occupancy
24	nviPerc1	SNVT_lev_percent
25	nviPerc2	SNVT_lev_percent
26	nviPerc3	SNVT_lev_percent
27	nviPerc4	SNVT_lev_percent
28	nviPerc5	SNVT_lev_percent
29	nviPerc6	SNVT_lev_percent
30	nviPerc7	SNVT_lev_percent
31	nviPerc8	SNVT_lev_percent
32	nviPPM1	SNVT_ppm
33	nviPress1	SNVT_press
34	nviPress2	SNVT_press

Offset	Network Variable Name	SNVT_Type
35 - 40	nviSetpt1	SNVT_temp_setpt
41	nviState1	SNVT_state
42	nviState2	SNVT_state
43	nviState3	SNVT_state
44	nviState4	SNVT_state
45 - 46	nviSw1	SNVT_switch
47 - 48	nviSw2	SNVT_switch
49 - 50	nviSw3	SNVT_switch
51 - 52	nviSw4	SNVT_switch
53 - 54	nviSw5	SNVT_switch
55 - 56	nviSw6	SNVT_switch
57 - 58	nviSw7	SNVT_switch
59 - 60	nviSw8	SNVT_switch
61	nviTemp1	SNVT_temp_p
62	nviTemp2	SNVT_temp_p
63	nviTemp3	SNVT_temp_p
64	nviTemp4	SNVT_temp_p
65	nviTemp5	SNVT_temp_p
66	nviTemp6	SNVT_temp_p
67	nviTemp7	SNVT_temp_p
68	nviTemp8	SNVT_temp_p
69 - 71	nviTodEv1	SNVT_tod_event
72	nviVltAC1	SNVT_volt_ac
73	nviVltAC2	SNVT_volt_ac
74	nviVolt1	SNVT_volt
75	nviVolt2	SNVT_volt

Table 1: Lon_In_01 Tag Layout.

LonWorks Output Variable Values can be found in the Lon_Out_01 Tag from Offset 4

Offset	Network Variable Name	SNVT_Type
0	Protocol Type	Not applicable
1	Node Status	Not applicable
2	Lon Block Number [1-25]	Not applicable
3	Reserved	Not applicable
4	nviAmp1	SNVT_amp
5	nviAmp2	SNVT_amp
6 - 8	nviChlr1	SNVT_chlr_status
9	nviCount1	SNVT_count_f
10	nviCount2	SNVT_count_f
11	nviCtInc1	SNVT_count_inc_f
12	nviCtInc2	SNVT_count_inc_f
13	nviFlow1	SNVT_flow_f
14	nviFreq1	SNVT_freq_hz
15	nviHVMod1	SNVT_hvac_mode
16 - 22	nviHVSts1	SNVT_hvac_status
23	nviLev1	SNVT_lev_cont
24 - 25	nviObj1	SNVT_obj_status
26	nviOcc1	SNVT_occupancy
27	nviOcc2	SNVT_occupancy
28	nviPerc1	SNVT_lev_percent
29	nviPerc2	SNVT_lev_percent
30	nviPerc3	SNVT_lev_percent
31	nviPerc4	SNVT_lev_percent
32	nviPerc5	SNVT_lev_percent
33	nviPerc6	SNVT_lev_percent
34	nviPerc7	SNVT_lev_percent
35	nviPerc8	SNVT_lev_percent
36	nviPPM1	SNVT_ppm

Offset	Network Variable Name	SNVT_Type
37	nviPress1	SNVT_press
38	nviPress2	SNVT_press
39 - 44	nviSetpt1	SNVT_temp_setpt
45	nviState1	SNVT_state
46	nviState2	SNVT_state
47	nviState3	SNVT_state
48	nviState4	SNVT_state
49 - 50	nviSw1	SNVT_switch
51 - 52	nviSw2	SNVT_switch
53 - 54	nviSw3	SNVT_switch
55 - 56	nviSw4	SNVT_switch
57 - 58	nviSw5	SNVT_switch
59 - 60	nviSw6	SNVT_switch
61 - 62	nviSw7	SNVT_switch
63 - 64	nviSw8	SNVT_switch
65	nviTemp1	SNVT_temp_p
66	nviTemp2	SNVT_temp_p
67	nviTemp3	SNVT_temp_p
68	nviTemp4	SNVT_temp_p
69	nviTemp5	SNVT_temp_p
70	nviTemp6	SNVT_temp_p
71	nviTemp7	SNVT_temp_p
72	nviTemp8	SNVT_temp_p
73 - 75	nviTodEv1	SNVT_tod_event
76	nviVltAC1	SNVT_volt_ac
77	nviVltAC2	SNVT_volt_ac
78	nviVolt1	SNVT_volt
79	nviVolt2	SNVT_volt

Table 2: Lon_Out_01 Tag Layout

5 ACCESSING ALL LONWORKS FUNCTION BLOCK DATA

The Quickstart example is for accessing only LonWorks Data in Functional blocks:

In[0] and Out[0]

5.1 Input Data from Function Blocks In[1] to In[24]

To access Input Data Blocks In[1] up to In[24] simply add to the existing ladder program as shown in the Quickstart example.

- Add a branch after the CPS element that copies the input image Tag and copy and paste EQU and CPS elements from the first rung.
- Create a new Input Tag for Lon_In_02 of type REAL and dimension 76.
- Finally, remember to set the EQU Source B value to 2 to compare for incoming data from the 2nd LonWorks functional block which is In[1].

See the ladder program below how to add In[1].

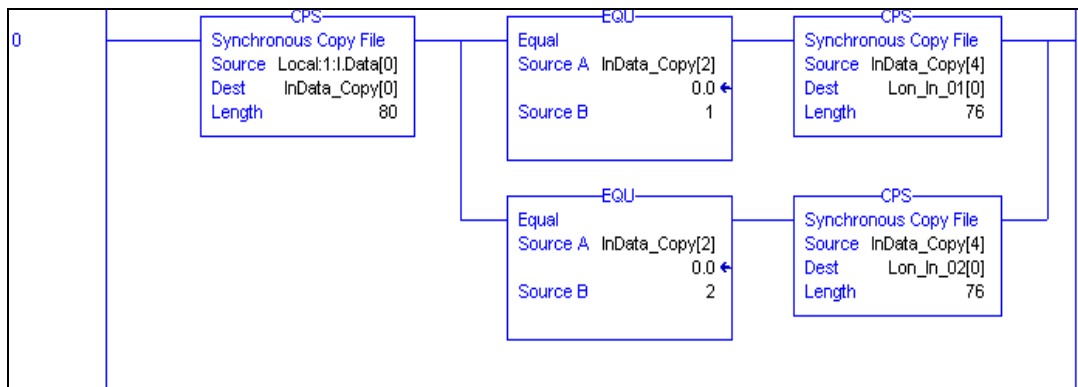

Very Important Note!

To ensure that the input data is from a specific LonWorks Function Block, make a synchronous copy of the input image data before using it.

5.2 Output Data from Function Blocks Out[1] to Out[24]

To access more output blocks it is necessary to create a Multiplexer in Ladder. The Flash Drive supplied with the product includes an ACD file with an example of multiplexing use.

The basic steps are:

- Create a Counter which counts up every 100ms.
- Place the counter value into the Lon_Out_xx Tag at offset 2.
- Copy the whole Tag into the output Data Image Tag for transferring to the LonWorks network.

The example program below shows an output counter that can count up to 25 which allows the transfer of data into all 25 Output Function Blocks. Only 2 rungs are shown to transfer data for blocks 1 and 2. Add more rungs with more Lon_Out_xx tags to transfer data to other output Function Blocks.

Very Important Note!

All Output Image Tag data must be updated once using a Synchronous File Copy element. Attempting to update the block number into the Output Image Tag followed by the data will cause an asynchronous transfer of data.

5.3 Optimizing performance for smaller applications

If less than the full number of Function Blocks is needed, it is advisable to trim the Preset value in the CTU element in the full SlotServer RSLogix project to the maximum block value. The blocks should be used starting from 1 upwards. This will ensure that update rate is kept as short as possible - e.g, if only block 25 is used and all the other points are left unbound and the project is untrimmed, when the data updates, the LonWorks driver will scan all the Map Descriptors for all blocks which will be unnecessarily time consuming.

Appendix A. Troubleshooting

Appendix A.1. Things to check when communications has failed.

- Check for loose cabling on the LonWorks network
- Verify that the bindings in the LonWorks network have not been broken by checking the variable status' with the LonWorks Network Manager.
- Verify that the correct program is loaded to the CPU
- Verify that the correct data types for the tags have been used.
- Verify with FieldServer that the newest version of the firmware version is being used.

Appendix B. Vendor Information

Appendix B.1. Using LonMaker to Commission a SlotServer

- Ensure that the SlotServer and the LonMaker PC are on the same LonWorks network.
- Open the existing Network in LonMaker, or create a new Network
 - Click on “Create New Network” and follow the network wizard, making the following selections:

Network Interface	Network Attached
Management Mode	Onnet (unless you are working offline)
Register Plug-ins required	None

- Once Visio is open with the Network showing, drag a new device onto the drawing from the toolbox.
- Follow the Device prompts, making the following selections

Enter Device Name	Commission device
Specify Device Template	Upload from device
Specify Device Channel	Auto Detect
Specify Device Properties	Leave as is (Ping is optional)
Identify Device	Service pin
Device Application Image	Leave unchecked
Initial State	Online

- Press the service pin on the SlotServer when asked to do so, and the SlotServer will be commissioned.
- Drag a new function block onto the drawing from the toolbox. Give the function block a name and ensure that it is allocated to the SlotServer device.
- Once the function block is on the drawing, drag input and output variables onto the function block. LonMaker will show the variables available for binding. Click on the required variables (or use the select all option), and they will be commissioned onto the function block.
- Connect these variables to other devices by dragging connections from the toolbox and connecting the variables.

Additional LonWorks information for other Network Managers can be found in the FieldServer LonWorks Driver Manual.

Appendix C. Reference

Appendix C.1. Network Variables List – SlotServer LonWorks Open Profile

The SlotServer LonWorks Open Interface Profile contains 50 Functional Blocks containing a total of 2,600 Network Variables of different SNVT Types.

Input Data Function Blocks:

In[0] - In[24]

Output Data Function Blocks:

Out[0] - Out[24]

Each Function Block contains the following Network Variables:

(nvi for Input Data Function Blocks, and nvo for Output Data Function Blocks)

Network Variable Name	SNVT_Type
nv(i)(o)Amp1	SNVT_amp
nv(i)(o)Amp2	SNVT_amp
nv(i)(o)Chlr1	SNVT_chlr_status
nv(i)(o)Count1	SNVT_count_f
nv(i)(o)Count2	SNVT_count_f
nv(i)(o)CtInc1	SNVT_count_inc_f
nv(i)(o)CtInc2	SNVT_count_inc_f
nv(i)(o)Flow1	SNVT_flow_f
nv(i)(o)Freq1	SNVT_freq_hz
nv(i)(o)HVMod1	SNVT_hvac_mode
nv(i)(o)HVSts1	SNVT_hvac_status
nv(i)(o)Lev1	SNVT_lev_cont
nv(i)(o)Obj1	SNVT_obj_status
nv(i)(o)Occ1	SNVT_occupancy
nv(i)(o)Occ2	SNVT_occupancy
nv(i)(o)Perc1	SNVT_lev_percent
nv(i)(o)Perc2	SNVT_lev_percent
nv(i)(o)Perc3	SNVT_lev_percent
nv(i)(o)Perc4	SNVT_lev_percent
nv(i)(o)Perc5	SNVT_lev_percent
nv(i)(o)Perc6	SNVT_lev_percent
nv(i)(o)Perc7	SNVT_lev_percent
nv(i)(o)Perc8	SNVT_lev_percent
nv(i)(o)PPM1	SNVT_ppm
nv(i)(o)Press1	SNVT_press
nv(i)(o)Press2	SNVT_press

Network Variable Name	SNVT_Type
nv(i)(o)Setpt1	SNVT_temp_setpt
nv(i)(o)State1	SNVT_state
nv(i)(o)State2	SNVT_state
nv(i)(o)State3	SNVT_state
nv(i)(o)State4	SNVT_state
nv(i)(o)Sw1	SNVT_switch
nv(i)(o)Sw2	SNVT_switch
nv(i)(o)Sw3	SNVT_switch
nv(i)(o)Sw4	SNVT_switch
nv(i)(o)Sw5	SNVT_switch
nv(i)(o)Sw6	SNVT_switch
nv(i)(o)Sw7	SNVT_switch
nv(i)(o)Sw8	SNVT_switch
nv(i)(o)Temp1	SNVT_temp_p
nv(i)(o)Temp2	SNVT_temp_p
nv(i)(o)Temp3	SNVT_temp_p
nv(i)(o)Temp4	SNVT_temp_p
nv(i)(o)Temp5	SNVT_temp_p
nv(i)(o)Temp6	SNVT_temp_p
nv(i)(o)Temp7	SNVT_temp_p
nv(i)(o)Temp8	SNVT_temp_p
nv(i)(o)TodEv1	SNVT_tod_event
nv(i)(o)VltAC1	SNVT_volt_ac
nv(i)(o)VltAC2	SNVT_volt_ac
nv(i)(o)Volt1	SNVT_volt
nv(i)(o)Volt2	SNVT_volt

Appendix C.2. Other Resources

- FieldServer LonWorks Driver Manual. (Available on the supplied USB drive).
- www.lonmark.org