



Where Automation Connects.



ICX30-HWC

Industrial Cellular Gateway

3G Cellular (M2M)

June 22, 2015

USER MANUAL

Your Feedback Please

We always want you to feel that you made the right decision to use our products. If you have suggestions, comments, compliments or complaints about our products, documentation, or support, please write or call us.

ProSoft Technology

5201 Truxtun Ave, 3rd Floor
Bakersfield, CA 93309
+1 (661) 716-5100
+1 (661) 716-5101 (Fax)
www.prosoft-technology.com
support@prosoft-technology.com

ICX30-HWC User Manual

June 22, 2015

ProSoft Technology[®], is a registered copyright of ProSoft Technology, Inc. All other brand or product names are or may be trademarks of, and are used to identify products and services of, their respective owners.

In an effort to conserve paper, ProSoft Technology no longer includes printed manuals with our product shipments. User Manuals, Datasheets, Sample Ladder Files, and Configuration Files are provided on the enclosed DVD and are available at no charge from our web site: <http://www.prosoft-technology.com>

Content Disclaimer

This documentation is not intended as a substitute for and is not to be used for determining suitability or reliability of these products for specific user applications. It is the duty of any such user or integrator to perform the appropriate and complete risk analysis, evaluation and testing of the products with respect to the relevant specific application or use thereof. Neither ProSoft Technology nor any of its affiliates or subsidiaries shall be responsible or liable for misuse of the information contained herein. Information in this document including illustrations, specifications and dimensions may contain technical inaccuracies or typographical errors. ProSoft Technology makes no warranty or representation as to its accuracy and assumes no liability for and reserves the right to correct such inaccuracies or errors at any time without notice. If you have any suggestions for improvements or amendments or have found errors in this publication, please notify us.

No part of this document may be reproduced in any form or by any means, electronic or mechanical, including photocopying, without express written permission of ProSoft Technology. All pertinent state, regional, and local safety regulations must be observed when installing and using this product. For reasons of safety and to help ensure compliance with documented system data, only the manufacturer should perform repairs to components. When devices are used for applications with technical safety requirements, the relevant instructions must be followed. Failure to use ProSoft Technology software or approved software with our hardware products may result in injury, harm, or improper operating results. Failure to observe this information can result in injury or equipment damage.

© 2015 ProSoft Technology. All Rights Reserved.

Printed documentation is available for purchase. Contact ProSoft Technology for pricing and availability.

Important Safety Information

- A** This Equipment is Suitable For Use in Class I, Division 2, Groups A, B, C, D or Non-Hazardous Locations Only.
- B** WARNING - EXPLOSION HAZARD - Substitution of Any Components May Impair Suitability for Class I, Division 2.
- C** WARNING - EXPLOSION HAZARD - Do not disconnect equipment unless power has been removed or the area is known to be non-hazardous.
- D** Device must be powered by a Class 2 Power Source.
- E** Device is open-type and is to be installed in an enclosure suitable for the environment that utilizes a tool removable door/cover.
- F** The RS-232 serial connector, Ethernet connector and I/O terminal block are not for use in Hazardous Locations; they are only for diagnostics and set-up only.
- G** When Antenna is installed into ultimate enclosure, it must be threaded to appropriate port to ensure mechanical securement.

Agency Approvals and Certifications

Agency

ATEX

CE

CSA/CB Safety

ETSI

FCC/IC

PTCRB

UL/cUL



Do not operate the ProSoft Technology Wireless products in areas where blasting is in progress, where explosive atmospheres may be present, near medical equipment, near life support equipment, or any equipment which may be susceptible to any form of radio interference. In such areas, the ProSoft Technology Wireless products **MUST BE POWERED OFF**. The ProSoft Technology Wireless products can transmit signals that could interfere with this equipment.

Do not operate the ProSoft Technology Wireless products in any aircraft, whether the aircraft is on the ground or in flight. In aircraft, the ProSoft Technology Wireless products **MUST BE POWERED OFF**. When operating, the ProSoft Technology Wireless products can transmit signals that could interfere with various onboard systems.

Note: Some airlines may permit the use of cellular phones while the aircraft is on the ground and the door is open. The ICX30-HWC may be used at this time.

The driver or operator of any vehicle should not operate the ProSoft Technology Wireless products while in control of a vehicle. Doing so will detract from the driver or operator's control and operation of that vehicle. In some states and provinces, operating such communications devices while in control of a vehicle is an offense.

Important Notice

Due to the nature of wireless communications, data transmission and reception can never be guaranteed. Data may be delayed, corrupted (that is, it may have errors), or be totally lost. Significant delays or losses of data are rare when wireless devices such as ProSoft Technology Wireless products are used in a normal manner with a well-constructed network. Nevertheless, the ICX30-HWC should not be used in situations where failure to transmit or receive data could result in damage of any kind to the user or any other party, including but not limited to personal injury, death, or loss of property. ProSoft Technology accepts no responsibility for damages of any kind resulting from delays or errors in data transmitted or received using ProSoft Technology products, or for failure of the ICX30-HWC to transmit or receive such data.

Limitation of Liability

The information in this manual is subject to change without notice, and does not represent a commitment on the part of ProSoft Technology.

PROSOFT TECHNOLOGY, INC AND ITS AFFILIATES SPECIFICALLY DISCLAIM LIABILITY FOR ANY AND ALL DIRECT, INDIRECT, SPECIAL, GENERAL, INCIDENTAL, CONSEQUENTIAL, PUNITIVE OR EXEMPLARY DAMAGES INCLUDING, BUT NOT LIMITED TO, LOSS OF PROFITS OR REVENUE OR ANTICIPATED PROFITS OR REVENUE ARISING OUT OF THE USE OR INABILITY TO USE ANY PROSOFT TECHNOLOGY PRODUCT, EVEN IF PROSOFT TECHNOLOGY AND/OR ITS AFFILIATES HAS BEEN ADVISED OF THE POSSIBILITY OF SUCH DAMAGES OR THEY ARE FORESEEABLE OR FOR CLAIMS BY ANY THIRD PARTY.

Notwithstanding the foregoing, in no event shall ProSoft Technology and/or its affiliates aggregate liability arising under or in connection with the ProSoft Technology product, regardless of the number of events, occurrences, or claims giving rise to liability, be in excess of the price paid by the purchaser for the ProSoft Technology product.

Release Version	Release Date	Description
1.1.50	5/28/15	<p>Fixes to Date:</p> <ul style="list-style-type: none">• Port Forwarding setup - Extra entries were deleted when user edited an entry on the port forwarding screen.• Port Forwarding setup was not properly displaying multiple entries.• A factory reset, disabled all the wireless modes except of the GSM• Removed duplicate version information from the main screen• Occasionally the system may reset itself to the factory default after repeated configuration and reboot changes• The ICX30 LAN IP address was not being updated properly <p>Enhancements:</p> <ul style="list-style-type: none">• GRE: Web interface for configuring a GRE Tunnel. Generic Routing Encapsulation (GRE) is a tunneling protocol that encapsulates a wide variety of network layer protocols inside virtual point-to-point links over an Internet Protocol network.

Contents

Your Feedback Please.....	2
Content Disclaimer.....	2
Important Safety Information.....	3
Important Notice.....	4
Limitation of Liability.....	4
1 Start Here	7
1.1 About the ICX30-HWC Industrial Cellular Gateway.....	7
1.1.1 Specifications.....	9
1.2 Package Contents.....	10
1.3 System Requirements.....	10
1.4 Power Requirements.....	11
2 Configuration Webpage	13
2.1 Configuration Webpage Setup.....	14
2.2 Assigning an IP Address to the ICX30-HWC.....	15
2.3 Connecting to your Cellular Provider.....	17
2.3.1 Steps of a connection using GSM/GPRS.....	17
2.3.2 Steps of a connection using CDMA (where applicable):.....	20
2.4 Configuration Webpage.....	21
2.4.1 Status.....	22
2.4.2 Network Interface.....	24
2.4.3 Advanced Setup.....	27
2.4.4 Administrator.....	35
3 Hardware Installation	37
3.1 Antenna Installation.....	37
3.2 Connecting the Radio to a Network Device.....	38
3.2.1 I/O Terminal.....	38
3.2.2 Ethernet Cable Specifications.....	40
3.2.3 Serial Port Basics.....	41
3.3 LED Indicators.....	42
4 GSM Communication (AT&T®)	43
4.1 HSUPA.....	43
4.2 HSDPA.....	43
4.3 UMTS.....	44
4.4 EDGE.....	44
4.5 GPRS.....	44
5 CDMA Communication (Verizon®)	45
5.1 EV-DO.....	45
5.2 1x.....	45

5.3	Security	46
6	Ethernet/IP Support	47
<hr/>		
6.1	Creating a New RSLogix 5000 Project	47
6.1.1	Adding a 1756-ENBT to the Project	48
6.1.2	Ethernet Bridge Network Setup	50
6.2	Importing the AOI	53
6.3	ICX30-HWC Controller Tags	56
6.3.1	ICX30.CONTROL	56
6.3.2	ICX30.STATUS	57
6.3.3	ICX30.SMS	57
6.3.4	ICX30.IO	58
6.3.5	ICX30.GPS	58
6.3.6	ICX30.UTIL	59
7	Support, Service & Warranty	61
<hr/>		
7.1	Contacting Technical Support.....	61
7.2	Warranty Information	62
Index		63
<hr/>		

1 Start Here

In This Chapter

❖ About the ICX30-HWC Industrial Cellular Gateway.....	7
❖ Package Contents	10
❖ System Requirements	10
❖ Power Requirements	11

1.1 About the ICX30-HWC Industrial Cellular Gateway

The Industrial Cellular Gateway provides secure wireless Ethernet and serial connectivity to remote devices such as PLCs, RTUs, DCS systems and instruments over 3G cellular services. Remote devices can be accessed using secure VPN tunnels over Internet connections. The ICX30-HWC is ideal for accessing remote equipment for maintenance/programming, remote data collection, SCADA, and machine-to-machine (M2M) applications.

Key applications include utilities, manufacturing, automation, oil and gas, SCADA, telemetry, Homeland Security, and asset monitoring.

Mobile Originated to Mobile Terminated (Cellular to Cellular)

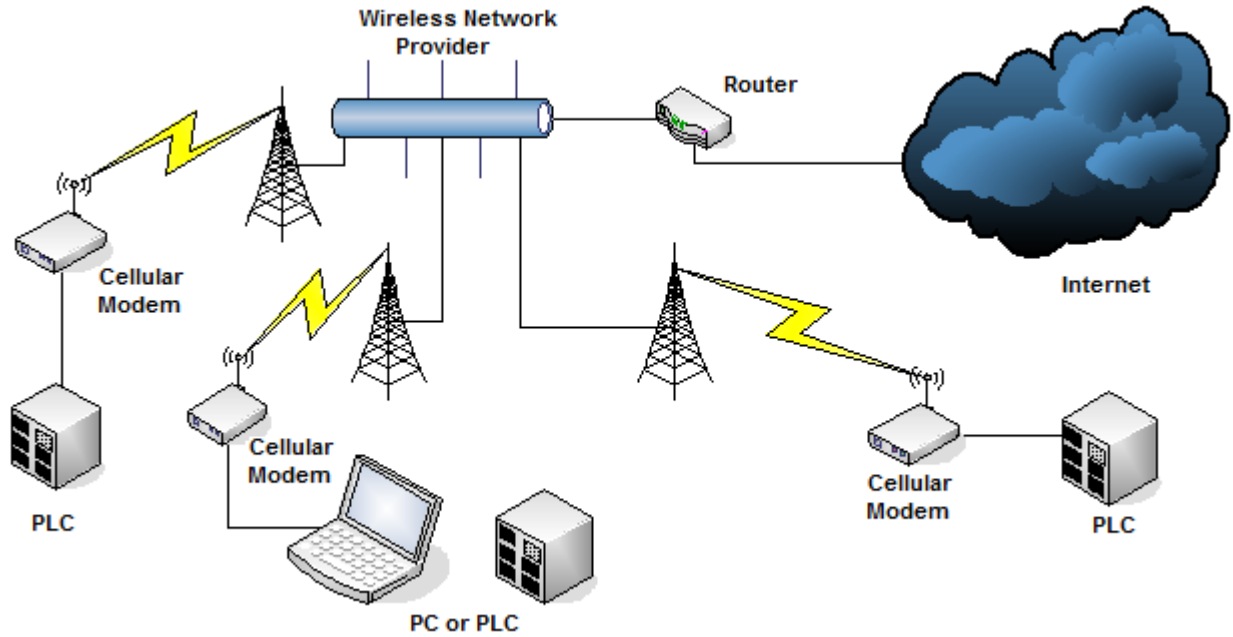

LAN to Mobile Terminated (Network to Cellular)

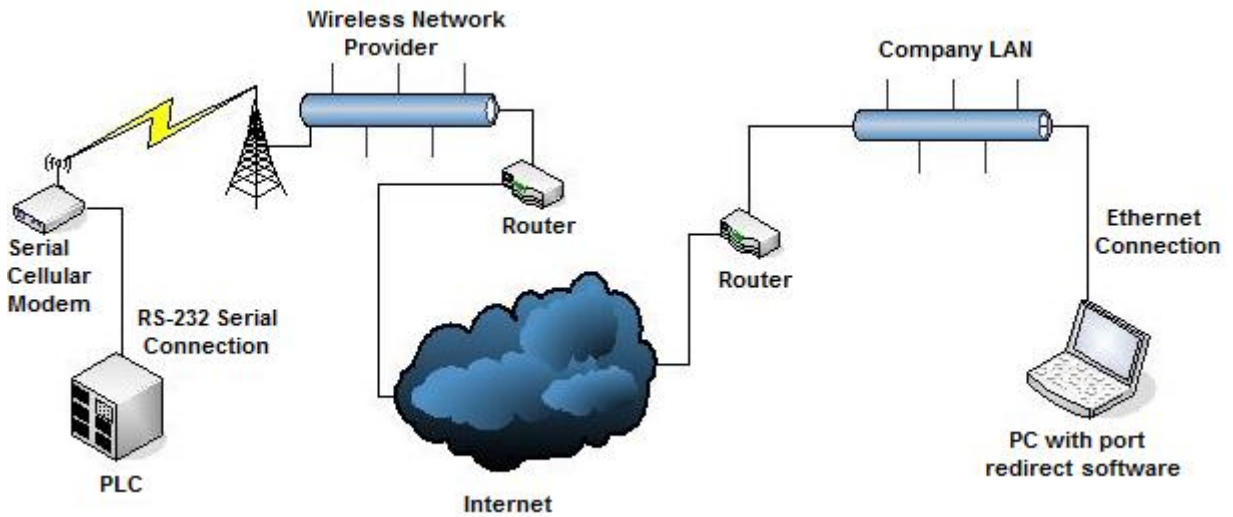

1.1.1 Specifications

Radio

Cellular Technology	CDMA, CDMA2000 GSM, UMTS/WCDMA, HSPA+, GPRS, EDGE
Bands	CDMA2000: 800/1900 MHz GSM: 850/900/1800/1900 WCDMA: 800/850/900/1900/2100
Max Downlink Speeds	Up to 14.4 Mbps maximum (Network dependent)
Max Uplink Speeds	Up to 5.76 Mbps maximum (Network dependent)
Activation	SIM Slot (GSM), Flash Memory (CDMA)
Security	Open VPN, IPSec
GPS	GPS EtherNet/IP reporting

Physical

Enclosure	Extruded aluminum with DIN clip
Size	11.4 x 14 x 3.2 cm (W x H x D) 4.5 x 5.5 x 1.25 inches (W x H x D)
Shock	IEC 60068-2-27; 15G @ 11ms (Operational) IEC 60068-2-27; 30G @ 18ms (Non-Operational)
Vibration	IEC 60068-2-6; 10G, 10 to 150 Hz
Ethernet Port	(1) 10/100 Base-T, RJ45 connector
Serial Port	(1) DB9 female (Serial tunneling & encapsulation)
Antenna Ports	(2) RP-SMA connector (1) SMA Connector (GPS)
I/O Connector	Six-position screw terminal
I/O Port	(2) Discrete Inputs/Outputs (Programmable) (2) Analog Inputs; (1) 0 to 20 mA, (1) 0 to 12 VDC
Weight	1.1 lbs (499g)

Environmental

Operating Temperature	-40°F to +158°F (-40°C to +70°C)
Humidity	Up to 100% RH, with no condensation
External Power	10 to 24 VDC
Power over Ethernet	802.3af Compliant
Peak Power Consumption	< 6W

1.2 Package Contents

The following components are included with the ICX30-HWC, and are required for installation and configuration.

Important: Before beginning the installation, please verify that all of the following items are present.

Qty.	Part Name	Part Number	Part Description
1	ICX30-HWC Cellular Gateway	ICX30-HWC	3G 3G Cellular (M2M)
1	Antenna	AO822S-OA	2dBi Omni RP-SMA articulating 890 to 960 MHz, 1710 to 2200 MHz
1	ProSoft Solutions DVD	DVD-001	Contains documentation for the ICX30-HWC

If any of these components are missing, please contact ProSoft Technology Support for replacement parts.

1.3 System Requirements

The following system requirements are the recommended minimum specifications to successfully install and run:

- Supported operating systems:
 - Microsoft Windows® Vista
 - Microsoft Windows XP Professional with Service Pack 1 or 2
 - Microsoft Windows 7 Professional (32-or 64-bit)
 - Microsoft Windows 2000 Professional with Service Pack 1, 2, or 3
 - Microsoft Windows Server 2003
- Pentium® II 450 MHz minimum. Pentium III 733 MHz (or better)
- 128 Mbytes of RAM minimum, 256 Mbytes of RAM recommended
- 100 Mbytes of free hard disk space (or more based on application requirements)
- 256-color VGA graphics adapter, 800 x 600 minimum resolution (True Color 1024 x 768 recommended)
- DVD drive
- Ethernet hub with standard RJ45 Ethernet cable
or
Ethernet port with RJ45 crossover cable for direct connection to module

In addition, you will need:

- A connection to an existing wired or wireless Ethernet network, with a Static or Dynamic IP address for your computer
- Static IP address, Subnet Mask and Gateway address for each device you plan to install. Obtain this information from your system administrator.

1.4 Power Requirements

The ICX30-HWC accepts voltages between 10 and 24 VDC (300 mA @ 12 VDC, 150 mA @ 24 VDC), with an average power draw of 6 watts or less. A detachable power connector comes with the radio, as shown below. The connector terminals are labeled + (positive DC connection) and - (DC ground connection).

The AC-to-DC power supply adapter may be used. DC power wires must be less than 2 meters in length to meet regulatory requirements.

Important: When wiring the power connector, be sure to observe the proper polarity markings on the power connector. Improper connector wiring can cause serious damage to the ICX30-HWC which will not be covered under the ProSoft Warranty.

The power connector (ProSoft P/N 002-0116) and wire installation tool (ProSoft P/N 357-0061) are shown in the following graphic. The wire installation tool is helpful when installing wires into the spring-loaded contacts inside the power connector.

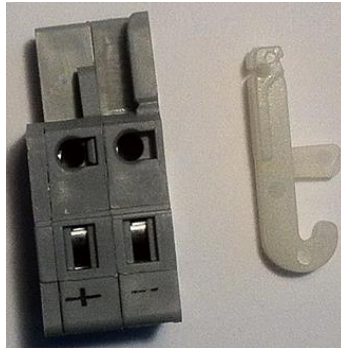

- 1 To use the wire installation tool, insert it into the connector as shown.

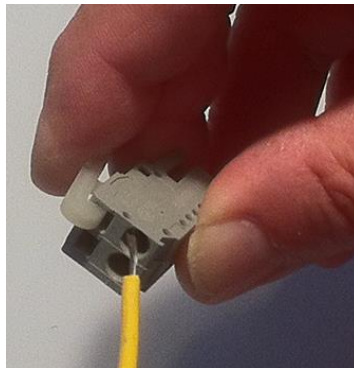

- 2 Press down on the installation tool to use it as a level which opens the connector's contacts to insert a wire. A properly wired connector is shown.



- 3 Insert the connector into the power port on the bottom of the ICX30-HWC.

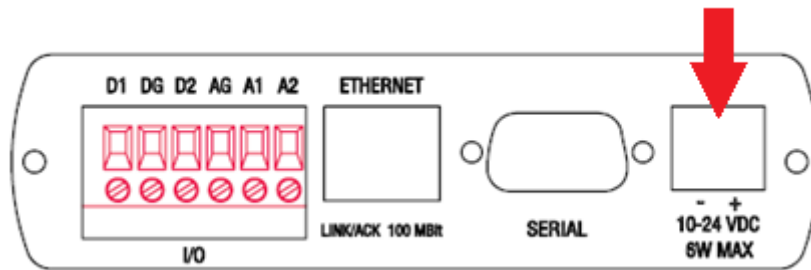

2 Configuration Webpage

In This Chapter

❖ Configuration Webpage Setup	14
❖ Assigning an IP Address to the ICX30-HWC.....	15
❖ Connecting to your Cellular Provider	17
❖ Configuration Webpage.....	21

The configuration webpage is used to configure and manage the ICX30-HWC. First-time setup must be performed over a wired network, where provider-specific cellular configuration details are configured. Once initially setup, you can access the webserver over the LAN and cellular networks (unless LAN access is disabled).

Key benefits of the web based configurator include:

- Login and configure device parameters
- Adjust network settings
- Change security settings
- Update events reporting
- Update firmware

2.1 Configuration Webpage Setup

- 1 The default IP address of the ICX30-HWC is 192.168.0.250. If your PC is on a different subnet, temporarily set the IP address of your PC to 192.168.0.xxx with a subnet of 255.255.255.0.

IP address:

Subnet mask:

- 2 Open a web browser and enter the ICX30-HWC default address of `http://192.168.0.250:8080`
- 3 Once the ICX30-HWC homepage opens, enter the **USERNAME** and **PASSWORD** to log in. You will be able to customize these later.
- 4 The default **USERNAME** is 'admin' and the default **PASSWORD** is 'password'.

Username

Password

- 5 After successful login, the homepage displays data from the *Status* tab.

The screenshot shows the configuration webpage interface. At the top, there are logos for ProSoft Technology and Radiolinx Industrial Cellular. Below the logos is a navigation menu with four tabs: Status, Network Interface, Advanced Setup, and Administrator. The 'Status' tab is selected. The main content area displays system information:

- System**
 - Up Time : 0day : 5h : 26m : 15s
 - System Time : 2013-12-13 22:48:38
 - Board F/W Version : ICX30-1.1.18-DF1 [201311280051]
 - Signal Level : -77 dBm
- WAN** : Ready to Connect
- Cell Net Disconnect** : 0
- LAN**
 - IP : 10.1.3.186
 - Netmask : 255.255.255.0
 - MAC : 00:0d:8d:a4:00:17
 - Received Packets : 11340 KBytes
 - Sent Packets : 16320 KBytes
- Serial**
 - Received Bytes : 0
 - Sent Bytes : 0
- Cellular Data Usage**

At the bottom of the status page, there is a jagged, black, irregular shape representing a data usage graph.

2.2 Assigning an IP Address to the ICX30-HWC

- 1 Mouse over the *Network Interface* heading and choose **LAN CONFIGURATION**.



- 2 Enter the **IP ADDRESS**, **SUBNET MASK**, and **DEFAULT GATEWAY** to be assigned to the ICX30-HWC. You will not need to edit the rest of the parameters at this time.

LAN Configuration

IP Address :	<input type="text" value="10.1.3.186"/>						
Subnet Mask :	<input type="text" value="255.255.255.0"/>						
Default Gateway :	<input type="text" value="10.1.3.1"/>						
Pass Thru IP :	<input type="checkbox"/> <input type="text"/>						
DHCP :	<input type="button" value="Disable"/>						
Connected Device :	<table border="1"><thead><tr><th>IP Address</th><th>MAC Address</th><th>Interface</th></tr></thead><tbody><tr><td>10.1.3.60</td><td>5c:26:0a:65:3c:9d</td><td>eth0</td></tr></tbody></table>	IP Address	MAC Address	Interface	10.1.3.60	5c:26:0a:65:3c:9d	eth0
IP Address	MAC Address	Interface					
10.1.3.60	5c:26:0a:65:3c:9d	eth0					
DHCP Client Range :	<input type="text" value="192.168.0.1"/> - <input type="text" value="192.168.0.10"/>						
1st DNS :	<input type="text" value="168.126.63.1"/>						
2nd DNS :	<input type="text" value="168.126.63.2"/>						
	<input type="button" value="Apply Changes"/> <input type="button" value="Clear"/>						

- 3 Click **APPLY CHANGES**. The ICX30-HWC will automatically reboot.

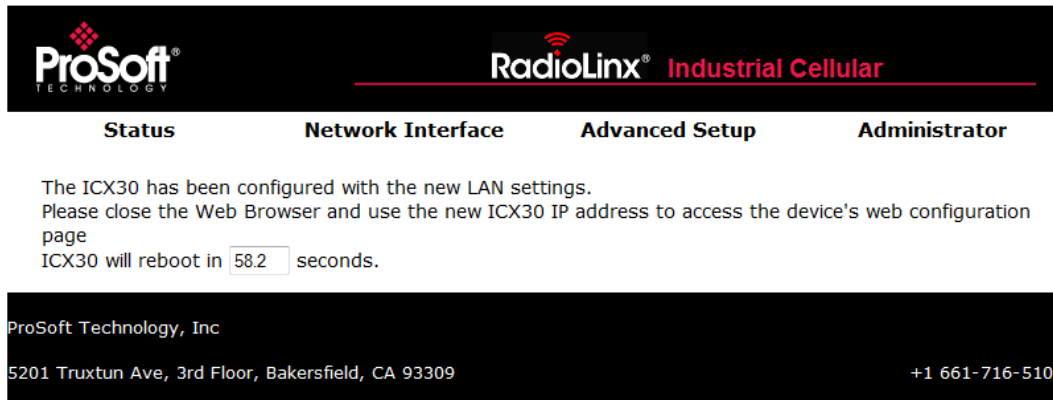

- 4 Once the reboot is complete, reset your PC back to its original IP address. This IP address should now be on the same subnet as the ICX30-HWC.
- 5 Close your browser and open a new session. Enter the new IP address of the ICX30-HWC to access the configuration webpage.

2.3 Connecting to your Cellular Provider

The ICX30-HWC supports 3G GSM/GPRS and CDMA (where applicable) networks. It uses your cellular provider as an ISP (Internet Service Provider) to connect you to the Internet.

- Cellular devices using GSM technology, such as AT&T, require a SIM (Subscriber Identity Module) card to be installed in the radio.
- Cellular devices using CDMA technology, such as Verizon, do not require a SIM card.

2.3.1 Steps of a connection using GSM/GPRS

The Subscriber Identity Module (SIM) in the ICX30-HWC is a smartcard that securely stores the key identifying a cellular subscriber. Generally, you will only need to install a SIM once in the life of the cellular gateway, and it may be pre-installed by your ProSoft Technology Representative.

The SIM card slot is located on the front of the cellular gateway.

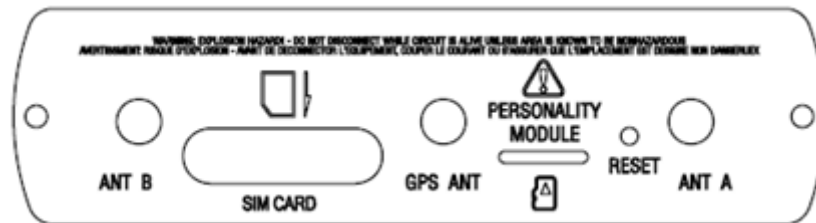

- 1 Insert the SIM card into the ICX30-HWC and cycle power. The SIM card is read by the ICX30-HWC upon boot up.
- 2 Open the *Network Interface > WAN Configuration* webpage.



- 3 Enter the *Access Point Name (APN)* information in the **APN NAME** field. This information is provided from your cellular provider. Click **APPLY CHANGES**. The ICX30-HWC will reboot.

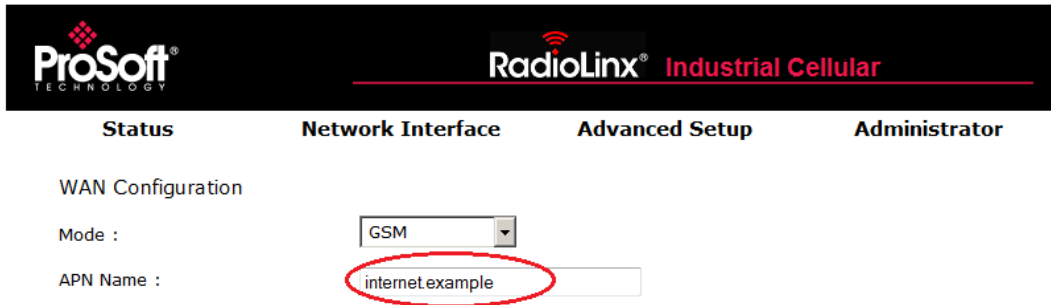

- 4 After the ICX30-HWC reboots, it establishes a PPP (Point to Point Protocol or "dial" up connection) link to your cellular provider network, also called registering on the network, and receives an IP address.
- 5 When the ICX30-HWC has received its IP address from your cellular provider, a connection to the Internet or the cellular network is also available for computers or other devices to connect directly to the ICX30-HWC.

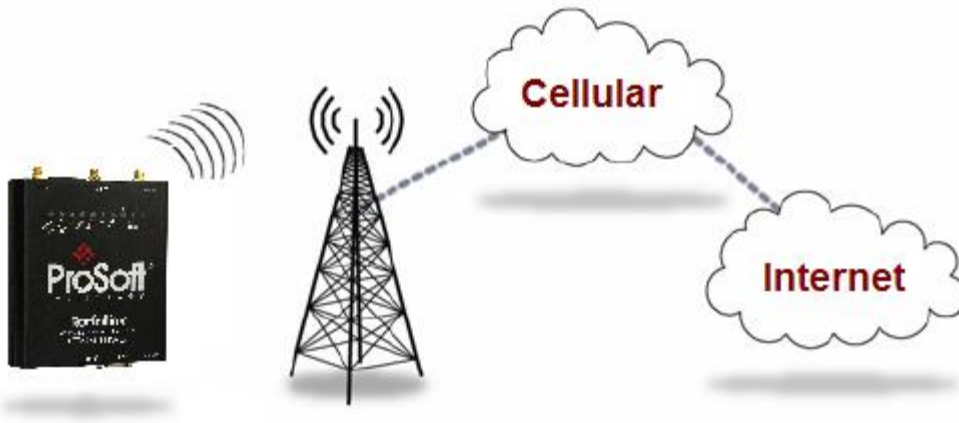

6 The GSM network information is now displayed on the *Status* web page.

The screenshot displays the 'Status' page of the ProSoft RadioLinX Industrial Cellular gateway. The page features a navigation bar with four tabs: 'Status', 'Network Interface', 'Advanced Setup', and 'Administrator'. The 'Status' tab is active, showing a 'System' section with various parameters and their values. A large black redaction box covers the IMEI, IMSI, and ICC fields. The network status is reported as 'PS attached in HSDPA/HSUPA capable cell'.

Parameter	Value
Up Time :	0day : 0h : 27m : 40s
System Time :	2014-02-03 05:11:30
IMEI :	[Redacted]
IMSI :	[Redacted]
ICC :	[Redacted]
Phone Number :	[Redacted]
Board F/W Version :	ICX30-1.1.36- [201401271037]
Cell Engine Version :	03.001
Network Registration :	AT&T [Local network registered]
PIN Status :	PIN request deactivated
Area Information :	LAI(310410), LAC(d921), CellID(036d0042)
Cell Engine Temp :	111.2 Fahrenheit / 44 Celsius
GPS :	Position Fix OK, Number of satellites 4, Coordinates 11903.64,W,3522.10,N
Signal Level :	-111 dBm
Network :	PS attached in HSDPA/HSUPA capable cell

2.3.2 Steps of a connection using CDMA (where applicable):

- 1 When your ICX30-HWC is powered on, it automatically searches for cellular service using CDMA-based cellular technology.
- 2 Your ICX30-HWC establishes a PPP (Point-to-Point Protocol or "dial" up connection) link to the Verizon network, also called registering on the network, and receives an IP address.
- 3 When your ICX30-HWC has received its IP address from your cellular provider, a connection to the Internet or the cellular network is also available for computers or other devices to connect directly to the ICX30-HWC.

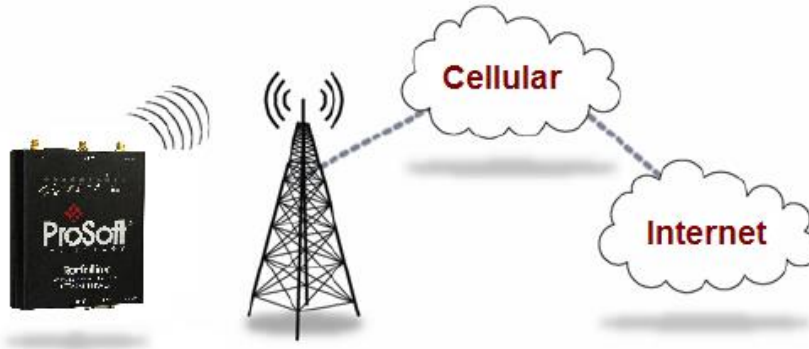

ProSoft TECHNOLOGY **RadioLinx** Industrial Cellular

Status **Network Interface** **Advanced Setup** **Administrator**

WAN Configuration

Mode :

Carrier : Verizon Sprint Custom

Dialup :

Periodic Reset : Hours

User Name :

Password :

Authentication :

Roaming :

Data Plan Limit :

Start Day

Plan Size

Data Block :

Ping Check :

ProSoft Technology, Inc
5201 Truxtun Ave, 3rd Floor, Bakersfield, CA 93309 +1 661-716-5100

2.4 Configuration Webpage

There are four main headings of the configuration webpage:

- *Status*
- *Network Interface*
- *Advanced Setup*
- *Administrator*

Mouse over each heading to reveal additional sub-headings.

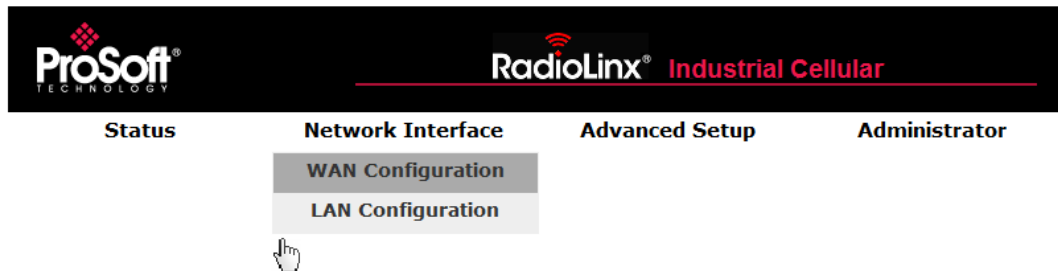

2.4.1 Status

The *Status* web page displays the current settings of the cellular gateway including up time, IP address, and cellular data usage.

ProSoft
TECHNOLOGY

RadioLinX Industrial Cellular

Status **Network Interface** **Advanced Setup** **Administrator**

System

Up Time : 0day : 18h : 29m : 39s
System Time : 2014-02-04 11:13:29
IMEI : [REDACTED]
IMSI : [REDACTED]
ICC : [REDACTED]
Phone Number : [REDACTED]
Board F/W Version : ICX30-1.1.36- [201401271037]
Cell Engine Version : 03.001
Network Registration : AT&T [Local network registered]
PIN Status : PIN request deactivated
Area Information : LAI(310410), LAC(d921), CellID(036d0042)
Cell Engine Temp : 102.2 Fahrenheit / 39 Celsius
GPS : Position Fix OK, Number of satellites 9, Coordinates 11903.63,W,3522.10,N
Signal Level : -103 dBm
Network : PS attached in HSDPA/HSUPA capable cell

WAN

Status : Connected
IP : 166.131.66.26
Sent Packets : 1 KBytes
Received Packets : 384 Bytes
Link Time : 0day : 0h : 2m : 40s
Disconnect Count : 0

LAN

IP : 10.1.3.186
Netmask : 255.255.255.0
MAC : 00:0d:8d:a4:00:1a
Received Packets : 39866 KBytes
Sent Packets : 199621 KBytes

Serial

Received Bytes : 0
Sent Bytes : 0

Cellular Data Usage

Current Day : 13 KB
Current Month : 50 KB
Previous Day : 25 KB
Previous Month : 0 Bytes

System	Description
Up Time	Amount of time the ICX30-HWC has been active since the last power cycle or a reset
System Time	Current date and time of the ICX30-HWC
IMEI	International Mobile Station Equipment Identity number
IMSI	International Mobile Subscriber Identity number
ICC	Integrated Circuit Card identifier - Unique to each SIM card
Phone Number	Phone number assigned to the SIM card
Board F/W Version	Firmware version of the cellular hardware
Cell Engine Version	Version of cellular engine processor
MEID (CDMA only)	Mobile equipment identifier number; unique CDMA equipment
Network Registration	Registered local cellular network
PIN Status	PIN request activated/deactivated
Area Information	LAI = Local Area Identity LAC = Location Area Code CellID = Cellular ID
Cell Engine Temp	Temperature of cellular engine processor
GPS	Position Fix: Invalid, OK Number of Satellites: 0 to 10 Coordinates: Longitude and Latitude
Signal Level	Signal level of cellular network (dBm)
Network	Type of cellular technology in use (Example: HSPA for GSM)
WAN	
Status	Status of cellular network connection
IP	IP Address of the ICX30-HWC on the WAN
Sent Packets	Total number of sent packets on the WAN
Received Packets	Total number of received packets on the WAN
Link Time	Number of days, hours, minutes, seconds connected to the WAN
Disconnect Count	Number of disconnects from the WAN
LAN	
IP	IP Address of the ICX30-HWC on the LAN
Netmask	Subnet mask
MAC	MAC address
Received Packets	Total number of received packets on the LAN
Sent Packets	Total number of sent packets on the LAN
Serial	
Received Bytes	Total number of bytes received on the serial port
Sent Bytes	Total number of bytes sent from the serial port
Cellular Data Usage	
Current Day	Number of bytes received and sent in the current day
Current Month	Number of bytes received and sent in the current month
Previous Day	Number of bytes received and sent from the previous day
Previous Month	Number of bytes received and sent from the previous month

2.4.2 Network Interface

The *Network Interface* tab allows you to configure the WAN (Wide Area Network) and LAN (Local Area Network) of the ICX30-HWC.

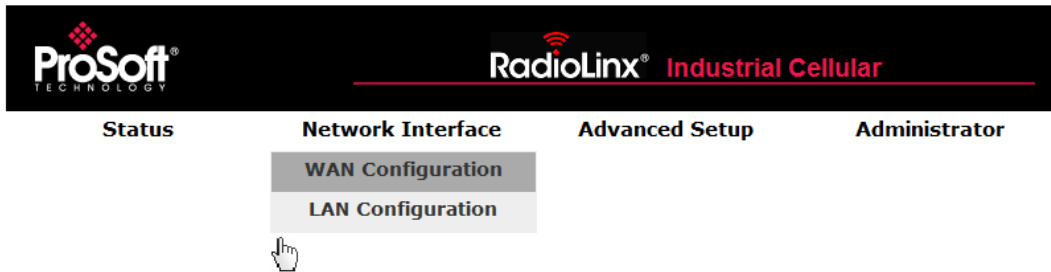

WAN Configuration

ICX30-HWC WAN configuration.

The screenshot shows the WAN Configuration page. The top navigation bar is the same as in the previous image. Below the navigation bar, the title "WAN Configuration" is displayed. The page contains several configuration fields:

- Mode : GSM
- APN Name :
- Auto PIN : PIN code
- Dialup :
- Periodic Reset : Hours
- User Name :
- Password :
- Authentication :
- Roaming :
- Data Plan Limit :
- Start Day
- Plan Size
- Data Block :
- Ping Check :

At the bottom of the form, there is an "Apply Changes" button.

WAN Configuration		Description
Mode		GSM or CDMA
APN Name		Access point name provided by the carrier
Auto PIN		Enable or Disable
	PIN Code	(Optional) PIN code to unlock SIM card
Carrier (CDMA only)		Verizon, Sprint, Custom
Dialup		Sequence to dial to establish a connection. This field cannot be left blank when you APPLY CHANGES . It will re-populate with a carrier-assigned value upon reboot.
Periodic Reset		Power cycle every X number of hours
User Name		(Optional) User name for connection assigned by the carrier upon reboot.
Password		(Optional) Password for connection assigned by the carrier upon reboot.
Authentication		PAP - Password Authentication Protocol CHAP - Challenge Handshake Authentication Protocol PAP & CHAP - Both are used
Roaming		Helps ensure a mobile ICX30-HWC stays connected
Data Plan Limit		Enable or Disable
	Start Day	Starting day of billing of each month
	Plan Size	With <i>Data Block</i> enabled, the maximum number of megabytes (MB) or gigabytes (GB) of 3G data usage before 3G communications are shut down until the next <i>Start Day</i> .
Data Block		Enable or Disable
Ping Check		Allows pinging two servers at set intervals. If fail count is reached on both servers, the ICX30-HWC disconnects from the WAN and cycles power.
	Interval	Trial interval time in seconds
	Fail Count	Maximum number of ping failures before reset
	1st Server	IP address of the 1st server to ping
	2nd Server	IP address of the 2nd server to ping

LAN Configuration

ICX30-HWC LAN configuration.

LAN Configuration	Description
IP Address	IP address of the ICX30-HWC on the LAN
Subnet Mask	Subnet mask of the ICX30-HWC on the LAN
Default Gateway	Gateway of the ICX30-HWC on the LAN
Pass Thru IP	IP address on the LAN to connect to through the ICX30-HWC
DHCP	Enable or Disable DHCP server of the ICX30-HWC
DHCP Client Range	IP address range for DHCP server
1st DNS	First domain name server IP address
2nd DNS	Second domain name server IP address

2.4.3 Advanced Setup

The *Advanced Setup* tab includes the setup for port forwarding, serial port, digital I/O, and analog input ports.

The screenshot displays the configuration interface for the ProSoft RadioLinx Industrial Cellular gateway. The top navigation bar includes the ProSoft logo and the product name. Below the navigation bar, there are four main tabs: Status, Network Interface, Advanced Setup, and Administrator. The Advanced Setup tab is currently selected, and a dropdown menu is open, listing various configuration options: Port Forward, MAC Filtering, Dynamic DNS, SNMP, Serial Port, VPN Tunnel(IPSEC), VPN Tunnel(OpenVPN), GRE Tunnel, Digital I/O, and Analog Input. The main content area is divided into sections: System, WAN, LAN, Serial, and Cellular Data Usage. Each section contains key-value pairs representing system status and configuration details.

Status	Network Interface	Advanced Setup	Administrator
System			
Up Time :	0day : 0h : 1m : 50s	Port Forward	
System Time :	1970-01-01 00:01	MAC Filtering	
IMEI :	990002189916495	Dynamic DNS	
Board F/W Version :	ICX30-1.1.49- [201	SNMP	
Cell Engine Version :	03.001	Serial Port	
Network Registration :	Not registered. The MS is not search	VPN Tunnel(IPSEC)	registered
PIN Status :	SIM Not Inserted	VPN Tunnel(OpenVPN)	
Cell Engine Temp :	32.0 Fahrenheit / 0	GRE Tunnel	inates 0.00,W,0.00,S
GPS :	Position Fix Invalid	Digital I/O	
WAN			
Status :	Waiting to register with network	Analog Input	
Disconnect Count :	0		
LAN			
IP :	192.168.0.250		
Netmask :	255.255.255.0		
MAC :	00:0d:8d:a4:00:0f		
Received Packets :	846 KBytes		
Sent Packets :	263 KBytes		
Serial			
Received Bytes :	0		
Sent Bytes :	0		
Cellular Data Usage			
Current Day :	0 Bytes		
Current Month :	0 Bytes		
Previous Day :	0 Bytes		
Previous Month :	0 Bytes		

ProSoft Technology, Inc

Port Forward

Port forwarding allows a remote computer or device to access a device on the ICX30-HWC LAN.

Port Forwarding	Description
IP Address	Redirect IP address: Target device IP address on the LAN
WAN Port	WAN port number range (1 to 65535)
LAN Port	LAN port number range (1 to 65535)

Note: There is a limit of nine (9) entries in the Port Forwarding table.

MAC Filtering

Entries in this table are used to restrict certain types of data packets from your local network to the Internet through the ICX30-HWC. These filters can be helpful in securing or restricting access to your local network.

MAC Filtering	Description
MAC Address	MAC address of the device allowed to connect to the internet

Dynamic DNS

Dynamic DNS (DDNS) is a method of mapping IP addresses that are assigned to a domain name.

Dynamic DNS	Description
Service Provider/Server	DDNS service web page
Domain Name	Sets the DDNS host name or alias from DDNS server
User Name/Email	User name to log into the DDNS server
Password/Key	Password to log into the DDNS server

SNMP

Simple Network Management Protocol (SNMP) is a set of protocols for managing a network. It is used to configure and collect information from network devices.

SNMP	Description
Activate	Enable or disable SNMP manager
System Name	System name of SNMP network
System Contact	Email address of SNMP network administrator
Write Community Name	Private: Write community string disabled (default) Public: Write community string enabled

SNMP	Description
Read Community Name	Private: Read community string disabled Public: Read community string enabled (default)
1st Trap Server IP	IP address of the 1st trap server. The ICX30-HWC will report the trap message this IP address
2nd Trap Server IP	IP address of the 2nd trap server. The ICX30-HWC will report the trap message this IP address
3rd Trap Server IP	IP address of the 3rd trap server. The ICX30-HWC will report the trap message this IP address
SNMPv3	Use SNMP version 3 reporting and features

Serial Port

The RS-232 serial port supports the Modbus and DF1 industrial communication protocols. For either protocol, a master or slave(s) can be connected to the ICX30-HWC serial port.

Serial Port	Description
Baud Rate	Baud rate used on the ICX30-HWC serial port
Data	Data bits
Parity	Parity
Stop	Stop bits
Flow Control	Flow control enable or disable
Characters Timeout	Number of characters the ICX30-HWC will wait until a timeout is determined from the device connected to the serial port.
Mode	Disable, Modbus Point-To-Point, Modbus Point-To-Multipoint, DF1 (see below)

Modbus Point-To-Point	Description
Server/Client	Server = ICX30-HWC serial port is connected to a Modbus slave Client = ICX30-HWC serial port is connected to a Modbus master
Remote ICX30 Server IP Address	(Client mode only) IP address of remote ICX30-HWC that is connected to the Modbus slave.

Modbus Point-To-Multipoint		Description
Server/Client		Server = ICX30-HWC serial port is connected to one or more Modbus slaves Client = ICX30-HWC serial port is connected to a Modbus master
TCP/IP Protocol		UDP
Remote ICX30 Server IP Address		(Server mode only) WAN IP address of Modbus master radio
	Port	Modbus service port, usually 502
Listen Port No.		(Client mode only) Defines the Modbus service port to listen to
Modbus		RTU or ASCII
	Add Address Mapping	(Client mode only) WAN IP address of Modbus slave radio
	Start ID	(Client mode only) Slave ID start
	End ID	(Client mode only) Slave ID end
DF1		Description
ICX30 Serial Port Master/Slave		Master = ICX30-HWC serial port is connected to a DF1 master Slave = ICX30-HWC serial port is connected to one or more DF1 slaves
Listen Port Number		(Master mode only) Defines which DF1 service port to listen to
	Add Remote ICX30 Address	(Master mode only) IP address of a remote ICX30 connected to a DF1 slave
	Slave ID	(Master mode only) DF1 slave ID of remote DF1 slave
Remote ICX30 Master IP Address		(Slave mode only) IP address of remote ICX30 connected to a DF1 master
	Port	(Slave mode only) Service port of remote ICX30 connected to a DF1 master

VPN Tunnel (IPSEC)

VPN Tunnel Internet Protocol Security (IPSEC). It consists of protocol(s) used for authentication and encryption.

VPN Tunnel (IPSEC)	Description
Gateway/Client	Disable, Client, or Gateway
Local Group	(Client mode) ICX30-HWC connects to a remote VPN server. LAN Subnet + USER FQDN, LAN Subnet + FQDN (Gateway mode) ICX30-HWC acts as a VPN server. IP + LAN Subnet
Local Group FQDN (User FQDN)	(Client mode only) Local group Fully Qualified Domain Name (FQDN) is user-defined. Ex. User_test1
Remote Group	(Client mode) IP + LAN Subnet (Gateway mode) Dynamic IP + USER FQDN, Dynamic IP + FQDN
Remote IP	(Client mode only) WAN IP address of gateway/ICX30-HWC
Remote Group IP	LAN IP address of gateway/ICX30-HWC. Only the first two octets are needed. Ex. XXX.YYY.0.0
Remote Group Subnet	255.255.255.0
Remote Group FQDN	(Gateway mode only) Remote group Fully Qualified Domain Name (FQDN) is user-defined. Ex. User_test1
Aggressive Mode	On
Pre-Shared Key	Key to connect in either mode
Phase 1 and 2 DH Group	MODP1024 or MODP1536
Phase 1 Encryption	DES, 3DES, AES192, or AES256
Phase 1 Authentication	MD5 or SHA1
Phase 2 Encryption	DES, 3DES, AES192, or AES256
Phase 2 Authentication	MD5 or SHA1

VPN Tunnel (Open VPN)

The Virtual Private Network (VPN) Tunnel allows you to access a private local network through the ICX30-HWC. The DHCP (LAN) must be enabled when using the VPN Tunnel.

VPN Tunnel (OpenVPN)	Description
Server/Client	Disable or Client
Interface Type	Network Tunnel (TUN)
Protocol	TCP or UDP
Authorization	Disable Transport Layer Security (TLS) authorization
Encryption Cipher	None, Use Default, AES-128-CBC, AES-192-CBC, or AES-256-CBC
TLS Renegotiation Time	Transport Layer Security renegotiation time in seconds
LZO Compression	Disabled, None, Enabled, Adaptive

VPN Tunnel (OpenVPN)	Description
Port	Service port number of the VPN server
Server Address	IP address of the VPN server
Custom Configuration	Optional configuration file for the VPN
Certificate Authority	VPN authentication that issues certificates for VPN, Secure Internal Communication (SIC), and users
Client Certificate	Issued by a certificate authority as proof of identity
Client Key	Password to corresponding client certificate

GRE Tunnel

GRE tunneling provides full connectivity between two sites without using encryption. GRE tunneling supports multiple routes and multiple endpoints over a single GRE tunnel.

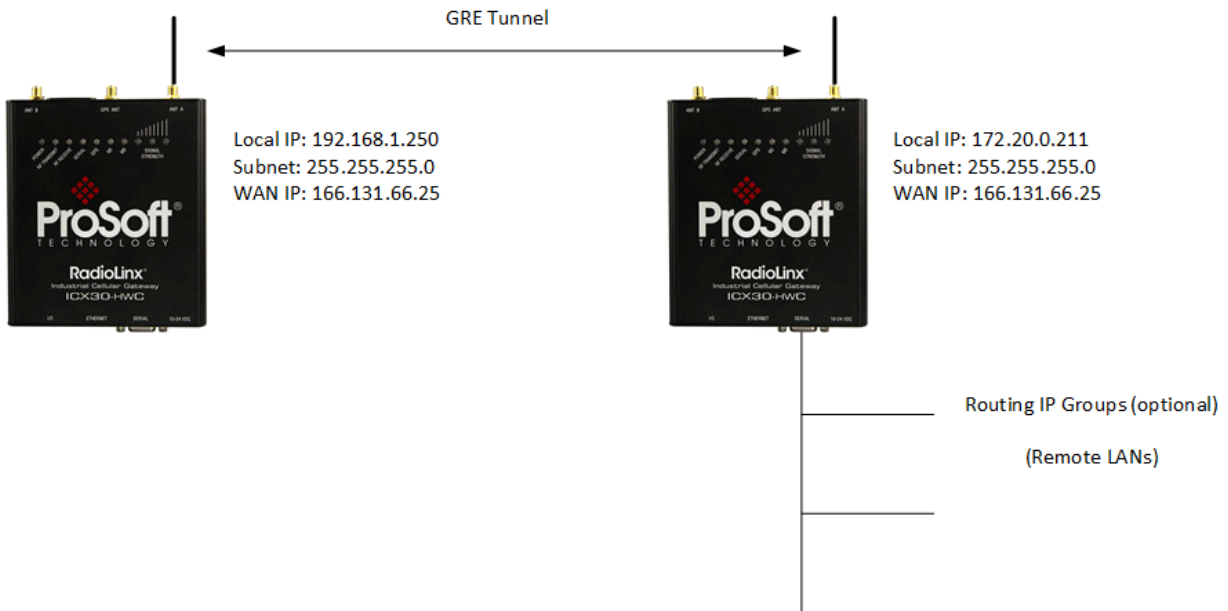

New configurations are saved on a micro SD card if inserted allowing modem reboot or configuration transfer via micro SD to another radio without loss of configuration data/fields.

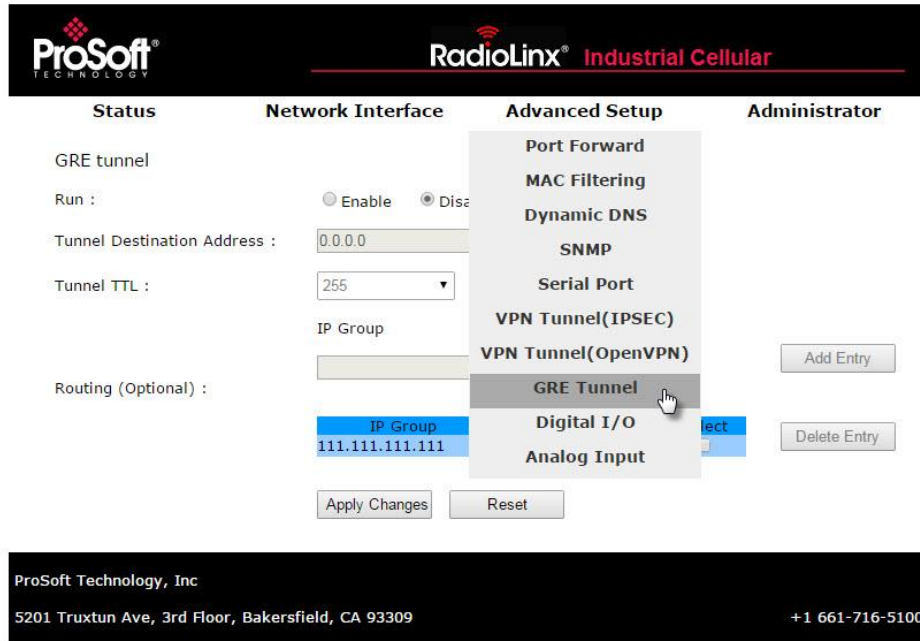

GRE Tunnel	Description
Run	Enable or Disable GRE Tunnel
Tunnel Destination Address	Enter the Tunnel Destination Address.
Tunnel TTL	Time a packet can remain on the network before being discarded.
Routing	Allows the configuration of multiple routes (optional).
IP Group	Enter a specific IP Group
Netmask	Enter a Netmask for the IP group.
Add Entry button	Adds the IP Group and Netmask to the Routing table
Delete Entry button	Deletes selected entries from the Routing table
Apply Changes button	Click when you are satisfied with your GRE Tunnel settings
Reset button	Resets all fields back to empty values.

Digital I/O

There are two digital input/output terminals on the ICX30-HWC. SMS text messages can be sent to up to five phone numbers upon the status change of a digital input.

Digital I/O	Description
No. 1	Input or Output
SMS Alarm Entry 1	Phone number 1 to send SMS text alarm
SMS Alarm Entry 2	Phone number 2 to send SMS text alarm
SMS Alarm Entry 3	Phone number 3 to send SMS text alarm
SMS Alarm Entry 4	Phone number 4 to send SMS text alarm
SMS Alarm Entry 5	Phone number 5 to send SMS text alarm
SMS Alarm Text	(Input only)
	Low
	Text of alarm to be sent to phone number(s) when status changes from High to Low
	High
	Text of alarm to be sent to phone number(s) when status changes from Low to High
No. 2	Input or Output
Toggle Output	(Output only)
Status	Digital No1 [OFF], Digital No2 [Open Drain]
	Digital No1 [OFF], Digital No2 [NULL]

Analog Input

There are two analog input channels for measuring voltage levels.

Analog Input	Description
Scan Rate	(250 to 10000 ms)
Channel 1	Voltage: 0 ~ 12 V
Channel 2	Current: 0 ~ 20 mA @ 2.2 V
Status	RAW Ain0: Raw analog input value for channel 1 (A1) RAW Ain1: Raw analog input value for channel 2 (A2)

2.4.4 Administrator

The *Administrator* tab allows you to configure the password, record logs, update firmware, etc.

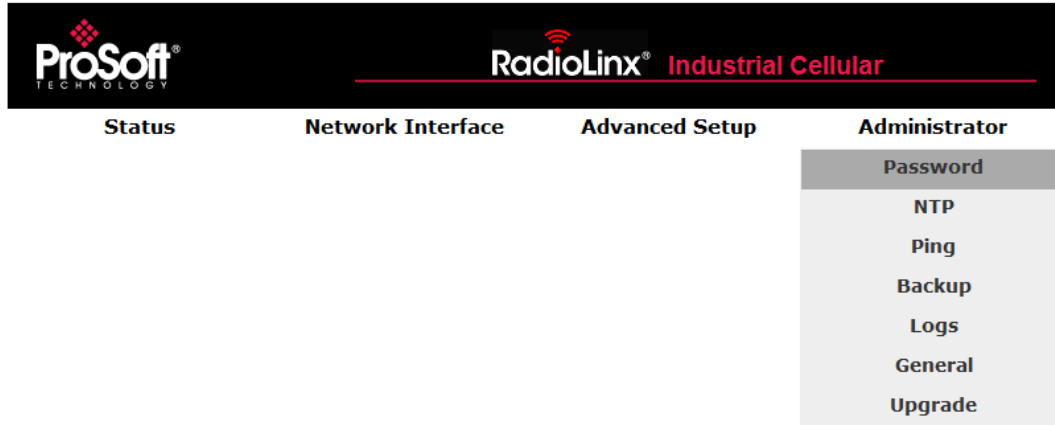

Password

Configure and edit the user name and password to access the configuration web page here.

Password	Description
Current Name	Current login user name
Current Password	Current login password
New Name	New login user name
New Password	New login password
Confirm Password	Re-enter the new login password

NTP

The Network Time Protocol (NTP) is used for clock synchronization between your ICX30-HWC and an NTP server.

NTP	Description
Current Time	Current Year, Month, Day, Hour, Minute, Second
Enable	Enables NTP client update with an NTP server
NTP Server	Address of NTP server
Time Zone	Local time zone of the ICX30-HWC

Ping

You can ping a remote device to determine whether you can connect to it.

Ping	Description
IP Address/Host Name	WAN IP address or host name to be pinged

Backup

The configuration of the ICX30-HWC can be saved to a file for backup. The file can also be loaded back into the ICX30-HWC. Restoring to factory default can be done here as well as pressing and holding the RESET button on the top of the radio.

Backup (Save/Reload)	Description
Save Settings to File	Saves configuration to a file
Load Settings from File	Browse for the selected configuration file and click UPLOAD
Restore to Factory Default	Restores to ICX30-HWC factory default

Logs

Record system logs of ICX30-HWC activity for analysis.

Logs	Description
Enable Logs	System logs enabled for review

General

Adjust the settings to access the configuration web page here.

General	Description
Web Access	Web access via HTTPS or HTTP, and Port Number
HTTP Access on WAN	Allows or blocks web page access from the WAN
NAT	Enable or disable network address translation

Firmware Update

Upgrade the ICX30-HWC firmware here.

Upgrade	Description
Select File	BROWSE and select the firmware file and click UPGRADE

3 Hardware Installation

In This Chapter

- ❖ Antenna Installation 37
- ❖ Connecting the Radio to a Network Device 38
- ❖ LED Indicators 42

The ICX30-HWC should be mounted in a position that allows easy access for the cables so they are not bent, constricted, in close proximity to high amperage, or exposed to extreme temperatures. The LEDs on the front panel should be visible for ease of operational verification. You should ensure that there is adequate airflow around the device but kept free from direct exposure to the elements, such as sun, rain, dust, and so on.

Caution: The ICX30-HWC is in a hardened case, and designed for use in industrial and extreme environments. However, unless you are using cables expressly designed for such environments, they can fail if exposed to the same conditions the ICX30-HWC can withstand.

3.1 Antenna Installation

Antennas selected should not exceed a maximum gain of 5 dBi under standard installation configuration. In more complex installations (such as those requiring long lengths of cable, and/or multiple connections), it is imperative that the installer follow maximum dBi gain guidelines in accordance with the radio communications regulations of the Federal Communications Commission (FCC), Industry Canada, or your country's regulatory body (if used outside the US).

Your ICX30-HWC will work with most quad-band GSM cellular antennas with a SMA connector. Connect the primary antenna or primary RF cable directly to the 'ANT A' antenna connector on the front of the ICX30-HWC.

A secondary antenna port labeled 'ANT B' is provided to attach an additional antenna. Use of a secondary antenna is not required, but will often increase cellular reliability and throughput performance.

This device is not intended for use within close proximity of the human body. Antenna installation should have at least 20 cm separation from the operator.

Tip: When using a cable to an antenna placed away from the modem, minimize the length of your cable. All gain from a more advantageous antenna placement can be lost with a long cable to the modem.

3.2 Connecting the Radio to a Network Device

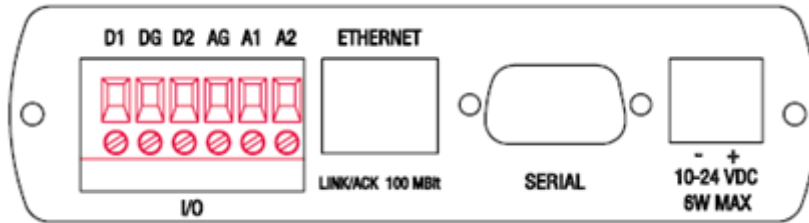

The application ports are located on the bottom of the radio.

- The I/O port uses (2) Discrete Inputs/Outputs and (1) Analog Input
- The Ethernet port uses a standard RJ45 connector
- The serial port uses a standard DB9 connector for RS-232 connectivity

3.2.1 I/O Terminal

There are two digital input/output and two analog terminals on the ICX30-HWC. An SMS text message can be configured and sent to your phone upon change of the digital input(s). (See Configuration Webpage)

Terminal	Description
D1	Digital terminal 1 can be configured as Input or Output
DG	Digital signal ground
D2	Digital terminal 2 can be configured as Input or Output
AG	Analog signal ground
A1	Analog input 1 voltage (0 ~ 12 V)
A2	Analog input 2 current (0 ~ 20 mA @ 2.2 V)

Electrical Specification of I/O Terminals

Limiting Values - (Outside of limiting value may damage hardware permanently, even for a short duration)

Terminal	Description
Digital input voltage	-5 ~ 20 V (on input mode)
Digital output sinking current	300 mA
Analog input (CH1) voltage	-0.5 ~ 3.5 V
Analog input (CH2) voltage	-1.5 ~ 18 V

Digital I/O

Digital I/O	Description
Operating input voltage range	-1 ~ 6 V (continuous)
Operating input voltage range	-1 ~ 15 V (within 1ms)
Input impedance	>1 KOhm
Operating output sinking current max	50 mA (continuous)
Operating output sinking current max	200 mA (within 1ms)
Output impedance	<30 Ohm
Output type	Open-drain

Analog Inputs (12 AD input)

Analog Input	Description
CH1 Input impedance	110 Ohm//0.1 uF
CH1 Input current	0 ~ 20 mA
CH1 Input voltage	0 ~ 2.2 V
CH2 Input impedance	49 KOhm//0.1 uF
CH2 Input voltage	0 ~ 10 V

Isolation Voltages

Isolation Voltage	Description
Voltage among any Power pins, RJ-45 Ethernet pins, AGND or DGND	> 500 V
Voltage between AGND to DGND	> 1 KV
Voltage between Power pins to AGND or DGND	> 1 KV

3.2.2 Ethernet Cable Specifications

The recommended Ethernet cable is category 5 or better. A category 5 cable has four twisted pairs of wire that are color-coded and cannot be swapped. The module only uses two of the four pairs when running at 10 MBit or 100 MBit speeds.

The Ethernet port on the module is Auto-Sensing. Use either a standard Ethernet straight-through cable or a crossover cable when connecting the module to an Ethernet hub, a 10/100/1000 Base-T Ethernet switch, or directly to a PC. The module will detect the cable type and use the appropriate pins to send and receive Ethernet signals.

Ethernet cabling is like U.S. telephone cables but have eight conductors. Some hubs have one input that can accept either a straight-through or crossover cable, depending on switch position. In this case, ensure that the switch position and cable type agree.

Ethernet Cable Configuration

Note: The standard connector view shown is color-coded for a straight-through cable.

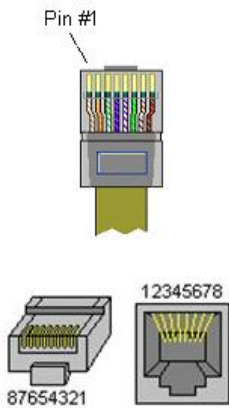
Crossover cable			Straight- through cable	
RJ-45 PIN	RJ-45 PIN		RJ-45 PIN	RJ-45 PIN
1 Rx+	3 Tx+		1 Rx+	1 Tx+
2 Rx-	6 Tx-		2 Rx-	2 Tx-
3 Tx+	1 Rx+		3 Tx+	3 Rx+
6 Tx-	2 Rx-		6 Tx-	6 Rx-

3.2.3 Serial Port Basics

The use of hardware handshaking (control and monitoring of signal lines) depends on the requirements of the networked device. If no hardware handshaking will be used, the cable to connect to the port is as shown below:

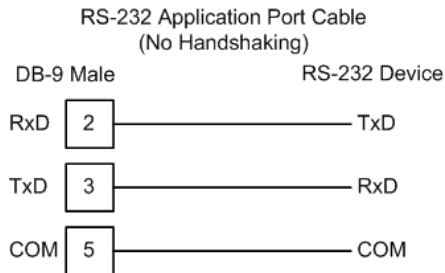

If hardware handshaking is required, the cable to connect to the port is as shown below:

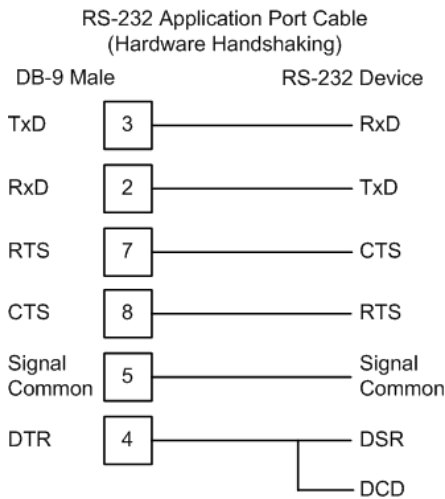

3.3 LED Indicators

LED	Color	State	Description
Power	Green	Steady	Remains lit while powered up.
RF Transmit	Green	Blinking	Data being transmitted out to the 3G network.
RF Receive	Green	Blinking	Data being received from the 3G network.
Serial	Green	Blinking	Data being transmitted or received on the serial port.
GPS	Green	Steady	GPS link established and running.
	Amber	Steady	GPS link not established, GPS antenna is disconnected.
NS	Cellular tower Network Status.		
	Off	Steady	-ICX30-HWC is powered off. -ICX30-HWC is waiting to register with the cellular network during power-up cycle.
	Green	Steady	ICX30-HWC connected to the cellular tower.
	Green	Blinking	ICX30-HWC is trying to connect to the cellular tower. The signal is too weak.
	Red	Steady	-A duplicate IP address has been discovered on the network. -Non-recoverable major network fault.
	Red	Blinking	-One or more established connections has timed out. The state remains until all time out connections have been re-established or a reset occurs. -Recoverable minor fault has occurred.
	Amber	Steady	Power-up sequence and tests.
	MS	Module Status	
Off		Steady	ICX30-HWC is powered off.
Green		Steady	ICX30-HWC is operating correctly with all initialization complete.
Green		Blinking	ICX30-HWC is in process of configuring or waiting for configuration information.
Red		Steady	ICX30-HWC has detected a non-recoverable major fault, (RAM error, corrupt storage, non unique MAC address) all errors which require more intervention than a power cycle to correct.
Red		Blinking	ICX30-HWC is booting up and reading it's configuration. -Recoverable minor fault detected, such as incomplete configuration. -Missing SIM card.
	Amber	Steady	Power-up sequence and tests.
Signal Strength	Green	Steady	3 LED's = Down to -83dB 2 LED's = -85dB to -95dB 1 LED = -97dB to -113dB

4 GSM Communication (AT&T®)

In This Chapter

❖ HSUPA	43
❖ HSDPA	43
❖ UMTS	44
❖ EDGE	44
❖ GPRS	44

Many GSM Networks have been upgraded to support HSUPA. GSM Networks use SIM cards which are smart cards containing the account holder's details. A SIM can generally be moved from one device to another allowing for account flexibility.

4.1 HSUPA

HSUPA (High-Speed Uplink Packet Access) is a cellular technology which most closely resembles a broadband synchronous connection. The upload and download speeds are maximized to provide a faster throughput, reaching speeds up to 2.0 Mbit/s for the uplink and 7.2 Mbit/s for the downlink. Please check with your network provider on the availability of HSUPA.

4.2 HSDPA

HSDPA (High-Speed Downlink Packet Access) is a cellular technology allowing for higher data transfer speeds. In HSDPA mode of operation, max speeds are up to 7.2 Mbit/s in the downlink and 384 kbit/s in the uplink. HSDPA uses Adaptive Modulation and Coding (AMC), fast packet scheduling at the Node B (Base Station) and fast retransmissions from Node B (known as HARQ-Hybrid Automatic Repeat Request) to deliver the improved downlink performance vs. UMTS and EDGE.

HSDPA (and HSUPA) falls back to UMTS, EDGE or GPRS (in order of precedence). This feature allows you to have seamless connectivity no matter where your ICX30-HWC is located.

4.3 UMTS

UMTS (Universal Mobile Telecommunications System) supports up to 1920 kbit/s data transfer rates, although most users can expect performance up to 384 kbit/s. A UMTS network uses a pair of 5 MHz channels, one in the 1900 MHz range for uplink and one in the 2100 MHz range for downlink.

4.4 EDGE

EDGE (Enhanced Data rates for GSM Evolution) provides end-to-end packet data services with an enhanced connectivity building on GPRS technology and using the established GSM networks. EDGE provides higher transmission rates and better transmission quality for data than GPRS. EDGE can carry data at speeds typically up to 384 kbit/s in packet mode.

When EDGE is not available, your ICX30-HWC will fall back to GPRS for the connection to your cellular provider to provide continued connectivity.

4.5 GPRS

General Packet Radio Service (GPRS) is packet-switched with many users sharing the same transmission channel, but only transmitting when they have data to send. This means that the total available bandwidth can be immediately dedicated to those users who are actually sending at any given moment, providing higher utilization where users only send or receive data intermittently. GPRS provides speeds of 30-70 kbps with bursts up to 170 kbps.

5 CDMA Communication (Verizon®)

In This Chapter

❖ EV-DO	45
❖ 1x	45
❖ Security	46

CDMA (Code Division Multiple Access), where applicable, is the underlying digital radio network technology used by many cellular providers across the globe and is prevalent in North America. To provide backward compatibility and seamless connections in a wider range of locations, your ICX30-HWC will fall back to 1x when EV-DO is not available.

ICX30-HWC is certified with the prominent North American 1x and EV-DO carriers.

5.1 EV-DO

EV-DO (Evolution Data Optimized) provides a broadband-like cellular data connection that is 10 times faster than 1x/CDMA service. With the high-speed connection, users can experience faster downloading when accessing the Internet and retrieving e-mails, including large attachments and other bandwidth-intensive applications. EV-DO is often referred to as Mobile Broadband and Cellular Broadband.

EV-DO revision A is an enhancement on the original revision 0 adding expanded upload capabilities and a more robust connection overall. In addition to increasing the downlink speed, revision A also increases the uplink speed. In addition, it is backwards compatible and automatically connects with existing and broadly deployed EV-DO Rev. 0 and 1x networks ensuring reliable and pervasive connectivity.

Note: Your ICX30-HWC does not have a second antenna for received diversity. Received diversity is disabled by default.

5.2 1x

1x provides a digital cellular telephony system and can provide wireless Internet access at speeds between 60 and 80 kbps, with bursts up to 144 kbps.

5.3 Security

1x and EV-DO data transmissions are highly secure. Originally developed based upon the "spread spectrum" pioneered by the US Department of Defense, security in CDMA technologies is obtained by spreading the digital information contained in a particular signal of interest over multiple coded paths, over a much greater bandwidth than the original signal.

6 Ethernet/IP Support

In This Chapter

- ❖ Creating a New RSLogix 5000 Project 47
- ❖ Importing the AOI 53
- ❖ ICX30-HWC Controller Tags 56

The ICX30-HWC provides connectivity via the Rockwell Ethernet/IP communications protocol as a Class 3 client. You can monitor and control remote I/O as well as send PLC to SMS text messages for alarms. Also, PLC's and SCADA software can monitor the diagnostics of the cellular gateway.

6.1 Creating a New RSLogix 5000 Project

- 1 Open the *File* menu and select **NEW**.

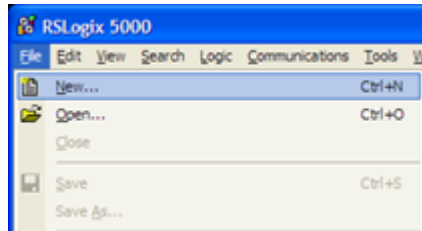

- 2 Select your controller **TYPE**.
- 3 Select the **REVISION** of your controller. (Revision 16 or newer only)
- 4 Enter a **NAME** for your controller, such as My_Controller.
- 5 Select your **CHASSIS TYPE**.

- 6 Select **SLOT** x indicating the slot location of your controller.

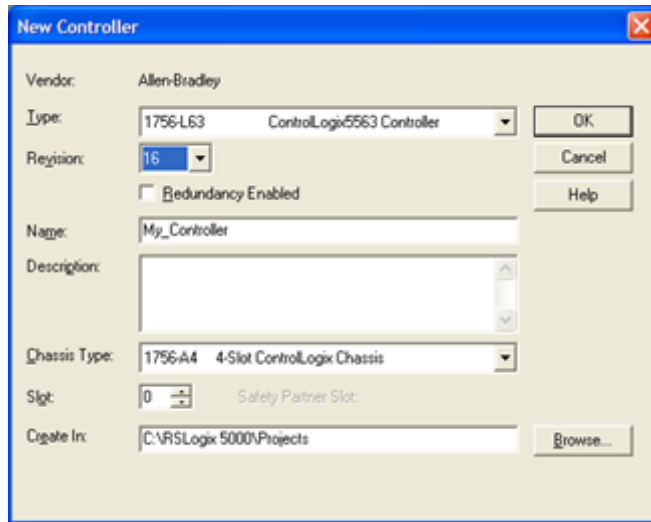

- 7 Click **OK**.

6.1.1 Adding a 1756-ENBT to the Project

- 1 You will need to add a 1756-ENBT Ethernet Bridge module to the project. In the *Controller Organization* window, select **I/O CONFIGURATION** and click the right mouse button to open a shortcut menu. On the shortcut menu, choose **NEW MODULE...**

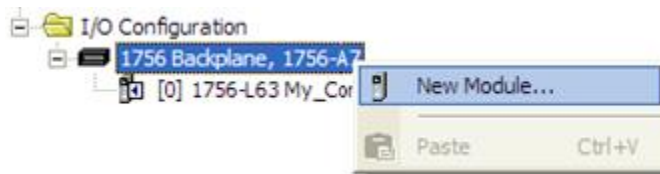

- 2 This action opens the *Select Module* dialog box. Select the **1756-ENBT** under the *Communications* directory and click **OK**.

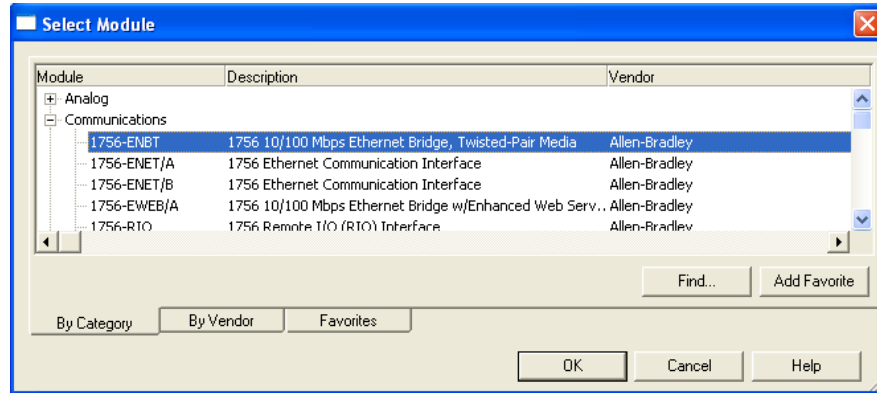

- 3 Enter the **NAME**, **SLOT**, **REVISION**, and **IP ADDRESS** of the 1756-ENBT module and click **OK**.

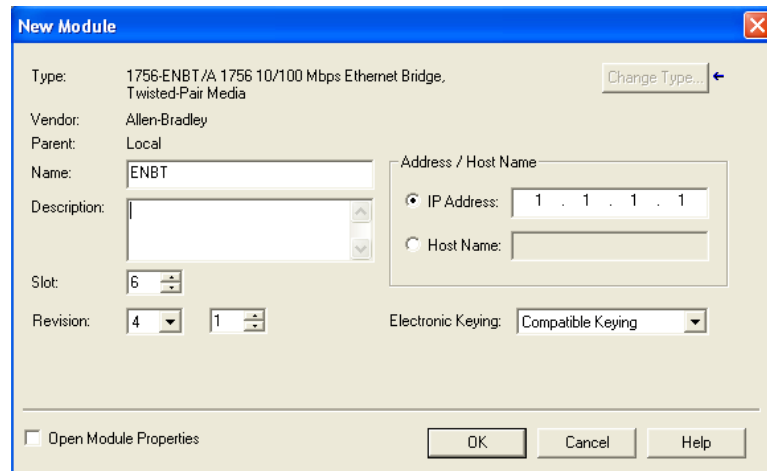

- 4 The 1756-ENBT module now appears in the *Controller Organization* window.

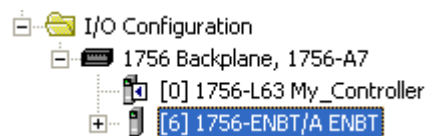

- 5 Save the RSLogix 5000 project.

6.1.2 Ethernet Bridge Network Setup

- 1 An Ethernet Bridge needs to be added to the 1756-ENBT module. In the *Controller Organization* window, click the right mouse button on the 1756-ENBT to open a shortcut menu. On the shortcut menu, choose **NEW MODULE...**

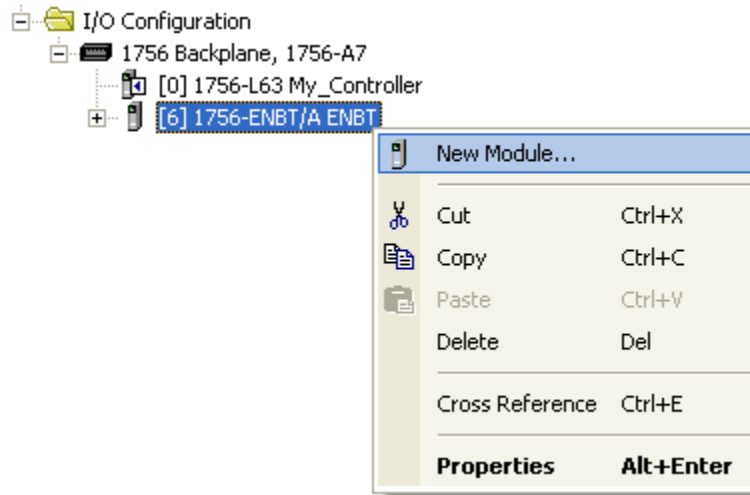

- 2 This action opens the *Select Module* dialog box. Select the **ETHERNET-BRIDGE** module under the *Communications* directory and click **OK**.

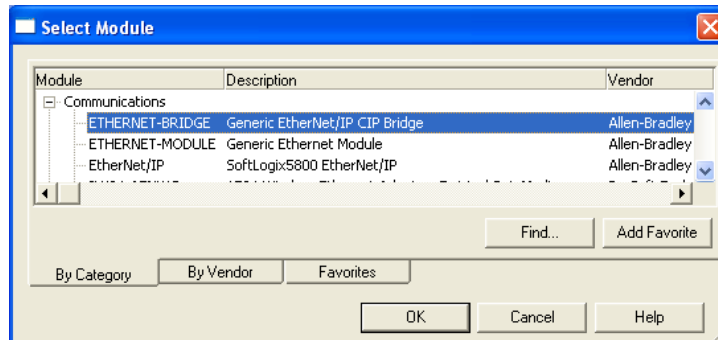

- This action opens the *New Module* dialog box. 'ICX30' must be entered as the **NAME**.

Note: The IP Address can be on the LAN or WAN. This is the connection to the outside world for the 1756-ENBT. A gateway may be needed if a different subnet is used.

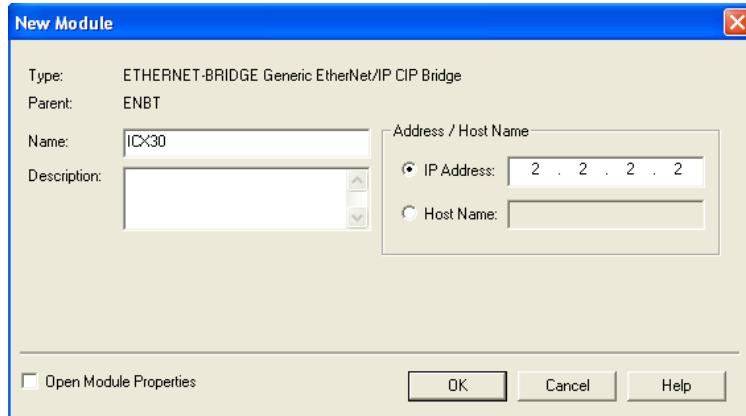

- The **ETHERNET-BRIDGE** now appears in the *Controller Organization* window under the 1756-ENBT module.

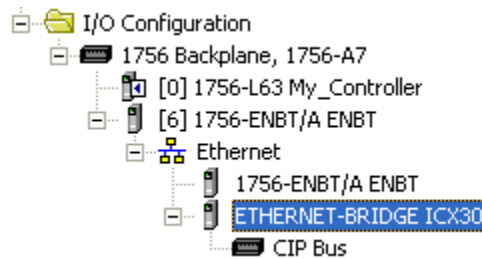

- 5 Double click the **ETHERNET-BRIDGE** icon in the *Controller Organization* window to open the *Module Properties* window. Click on the *Connection* tab and check the **INHIBIT MODULE** box. Click **OK**.

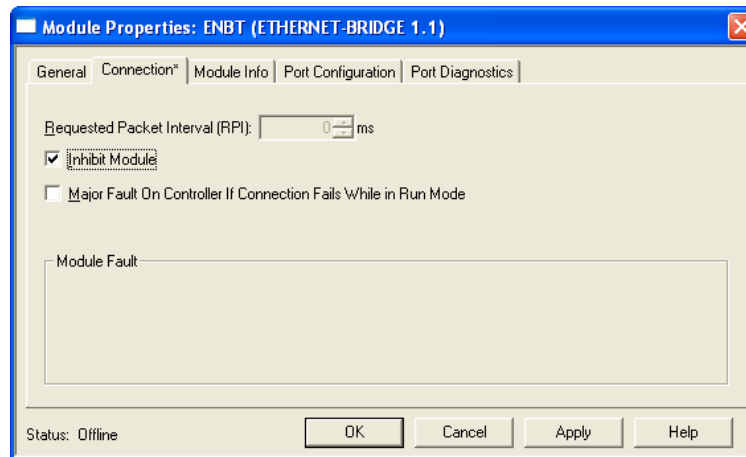

- 6 Save the file.

6.2 Importing the AOI

- 1 In the *Controller Organization* window, expand the *Tasks* folder and subfolders until you reach the *MainProgram* folder.
- 2 In the *MainProgram* folder, double-click to open the **MAINROUTINE** ladder.
- 3 Select an empty rung in the routine, and click the right mouse button to open a shortcut menu. On the shortcut menu, choose **IMPORT RUNGS...**

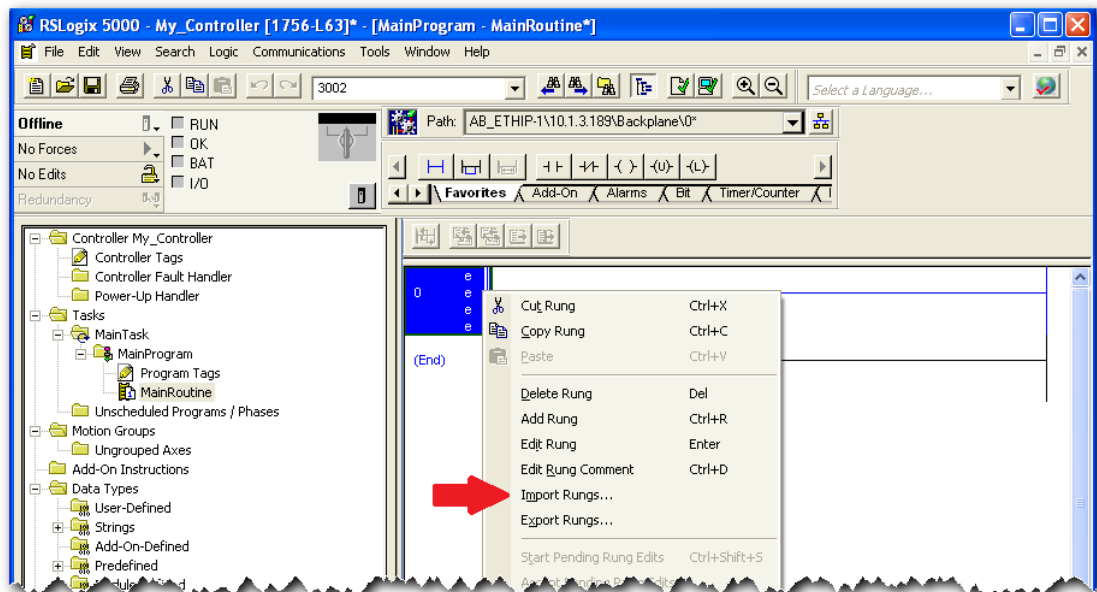

- Navigate to the location on your PC where you saved the Add-On Instruction (for example, Desktop). Select the .L5X file and click **IMPORT**.

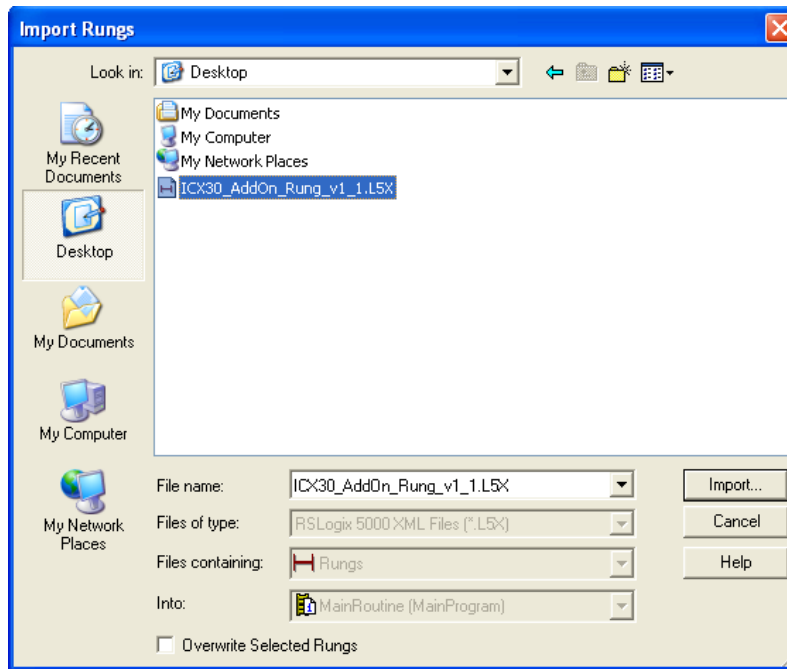

- This action opens the *Import Configuration* dialog box, showing the controller tags that will be created.

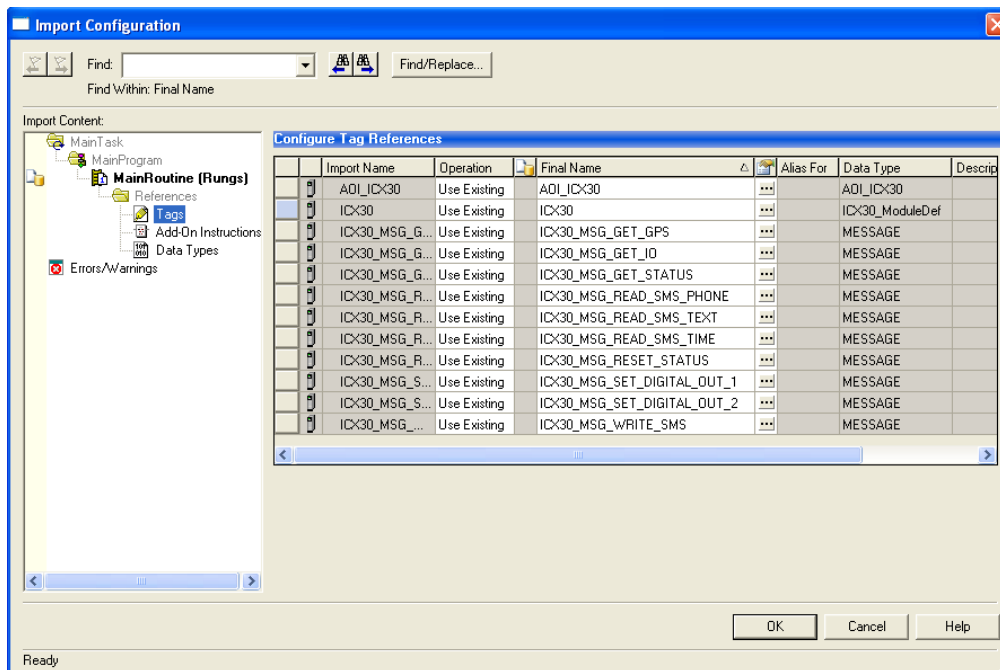

- Click **OK** to confirm the import. RSLogix will indicate that the import is in progress:

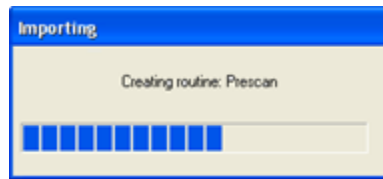

- When the import is completed, the new rung with the Add-On Instruction will be visible as shown in the following illustration.

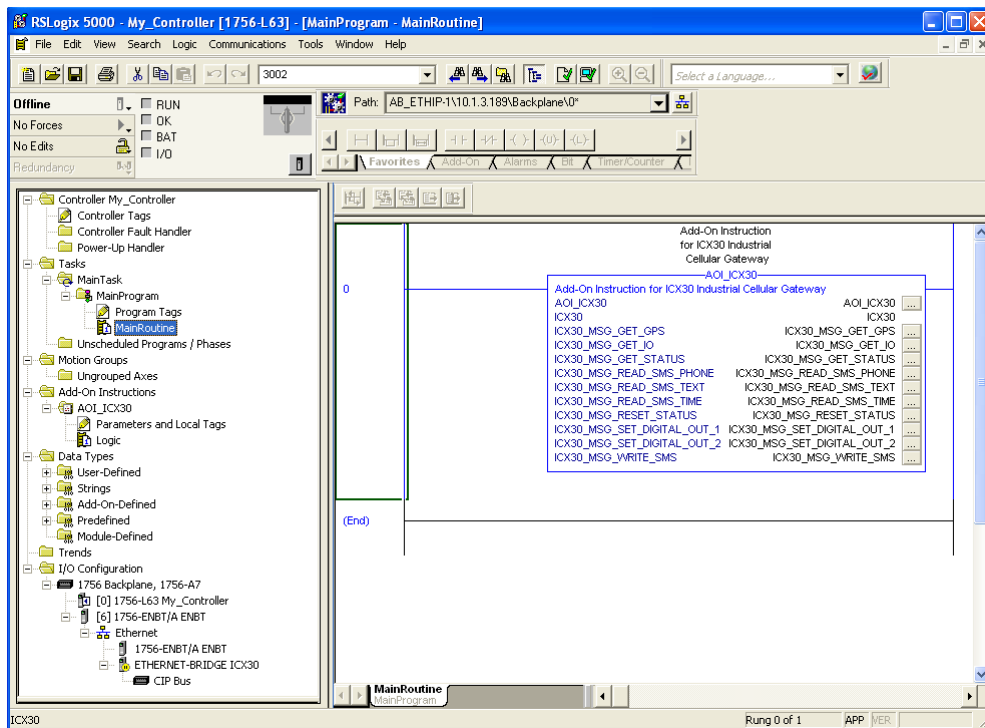

- The procedure has also imported new User Defined Data Types, Controller Tags, and the Add-On instruction for your project.



- Save the project. When ready, download the project to the processor.

6.3 ICX30-HWC Controller Tags

Controller Tags are used to monitor and control elements of the ICX30-HWC from RSLogix 5000. You will only use the ICX30.xxx controller tag structure.

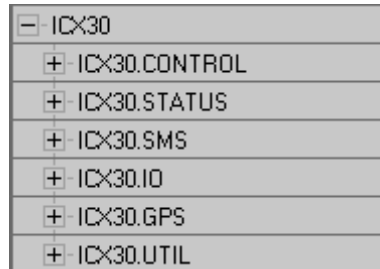

6.3.1 ICX30.CONTROL

This array contains trigger bits used to request functions from the ICX30-HWC. After execution, the bit will automatically reset to '0', ready for the next execution.

ICX30.CONTROL.	Value	Description
Get_Status	0 or 1	Reads status data from the ICX30-HWC. This data will populate in the ICX30.STATUS tag array.
Reset_Status	0 or 1	Resets status counters in the ICX30.STATUS tag array.
Write_SMS	0 or 1	Sends SMS message from the ICX30-HWC to the target device(s). Maximum 160 characters.
Read_SMS	0 or 1	Reads SMS message being sent to the ICX30-HWC from remote device. Maximum 160 characters.
Get_Digital_Analog_Input	0 or 1	Reads Digital/Analog Input values from the ICX30-HWC.
Set_Digital_Output_1	0 or 1	Sets digital output 1.
Set_Digital_Output_2	0 or 1	Sets digital output 2.
Get_GPS	0 or 1	Reads GPS data from the ICX30-HWC.

6.3.2 ICX30.STATUS

This array is populated when the ICX30.CONTROL.Get_Status tag is triggered.

A partial list of the data includes:

- Signal strength
- MAC ID and IP Address
- Digital and Analog port data
- WAN and LAN data usage
- 3G network and SMS text data usage
- Uptime
- Temperature
- Firmware version

Please see each tag in the ICX30.STATUS array for its corresponding definition.

6.3.3 ICX30.SMS

This array contains the SMS text data for sending and receiving text messages.

The ICX30.SMS.READ array contains the SMS text message data received by the ICX30-HWC. If the ICX30-HWC receives a new SMS text message, the ICX30.STATUS.SMS_MSGs_Received tag will increment by one. This tag refreshes by triggering the ICX30.CONTROL.Read_SMS tag.

The data in this array is overwritten on every re-trigger of the ICX30.CONTROL.Read_SMS tag.

ICX30.SMS.READ.	Value	Description
DateTime	ASCII String	Date and time of received SMS text message.
Phone_Number	ASCII String	Phone number of sender including country and area code prefixes. (Ex: 16617165100)
Text_Str	ASCII String	Received message text - Maximum 160 characters.

The ICX30.SMS.WRITE array contains the SMS text message data to send to multiple SMS text devices. This array must be populated before sending the message by triggering the ICX30.CONTROL.Write_SMS tag.

ICX30.SMS.WRITE.	Value	Description
Message_Byte_Count	1 to 160	Number of characters in the message.
Message	ASCII String	Text of message to be sent - Maximum 160 characters.
Phone_Count	1 to 5	Quantity of phone numbers to send to.
Ph_Number_X	ASCII String	Phone number target device including country and area code prefixes (Ex: 16617165100). Up to 5 phone numbers.

6.3.4 ICX30.IO

This array contains the Analog and Digital input values of the ICX30-HWC. This array is updated by triggering the ICX30.CONTROL.Get_Digital_Analog_Input tag.

Caution: The data in this array is overwritten on every re-trigger of the ICX30.CONTROL.Get_Digital_Analog_Input tag.

ICX30.IO.	Value	Description
Analog_1	0 to 32767	Analog input 1 raw value
Analog_2	0 to 32767	Analog input 2 raw value
Digital_1	0 or 1	Digital input 1 raw value (when output 1=no current, 0=current flow)
Digital_2	0 or 1	Digital input 2 raw value (when output 1=no current, 0=current flow)

6.3.5 ICX30.GPS

This array contains the current ICX30-HWC GPS data. This array is updated by triggering the ICX30.CONTROL.Get_GPS tag.

Caution: The data in this array is overwritten on every re-trigger of the ICX30.CONTROL.Get_GPS tag.

ICX30.GPS.	Value	Description
UTC_Time	Real	UTC Time in HHMMSS.x format. H=hour, M=minute, S=second
Latitude	Real	Latitude in dddmm.mmmm format, d=degrees, m=minutes
Longitude	Real	Longitude in dddmm.mmmm format, d= degrees, m=minutes
Horiz_Dilution	Real	Horizontal Dilution of precision.
Altitude	Real	Altitude in meters above sea level.
GEOID_Height	SINT	Geoid Height in meters.
Last_Update_Interval	SINT	Time since last update.
Fix_Quality	SINT	GPS signal quality. 0 = Invalid 1 = Ideal 1 to 2 = Excellent 2 to 4 = Good 4 to 8 = Moderate
Satellite_Num	SINT	Number of Satellites in range.

Converting latitude and longitude coordinates to decimal degrees:

The latitude and longitude values are both displayed in the following format:
dddmm.mmmm where *d* = degrees and *m* = minutes

To convert the number of minutes to a decimal value, use the following formula:

Decimal value = Minutes / 60

Example:

ProSoft Technology Headquarters: Bakersfield, California, USA

Latitude: **3522.086288,N**

Longitude: **11903.627399,W**

Latitude decimal degrees: $35 + (22.086288 / 60) = 35.36810$

Longitude decimal degrees: $119 + (3.627399 / 60) = -119.06046$

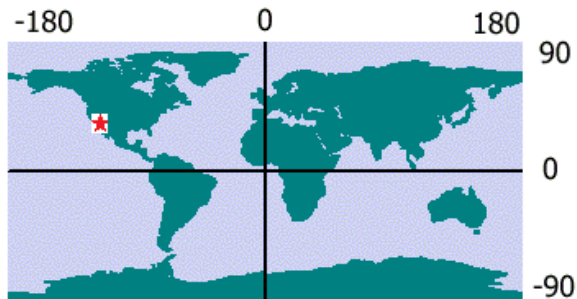
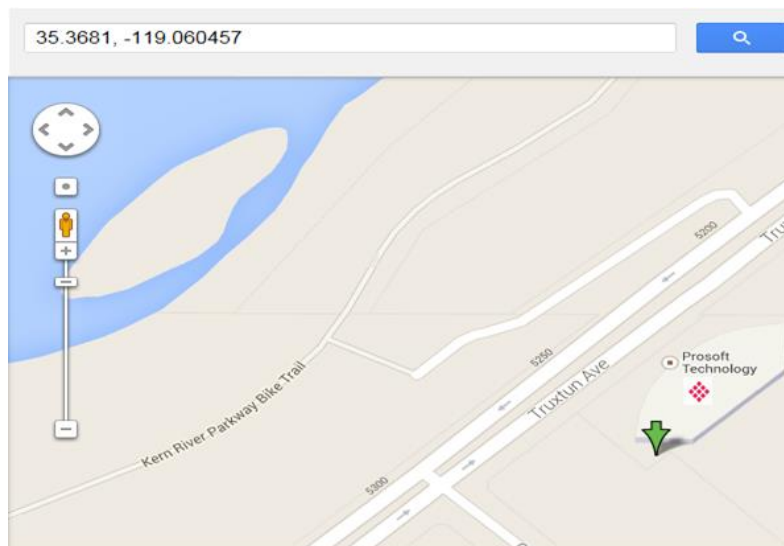

6.3.6 ICX30.UTIL

The ICX30.UTIL tag array does not need to be edited.

7 Support, Service & Warranty

In This Chapter

- ❖ Contacting Technical Support 61
- ❖ Warranty Information 62

7.1 Contacting Technical Support

ProSoft Technology, Inc. is committed to providing the most efficient and effective support possible. Before calling, please gather the following information to assist in expediting this process:

- 1 Product Version Number
- 2 System architecture
- 3 Network details

If the issue is hardware related, we will also need information regarding:

- 1 Module configuration and associated ladder files, if any
- 2 Module operation and any unusual behavior
- 3 Configuration/Debug status information
- 4 LED patterns
- 5 Details about the serial, Ethernet or Fieldbus devices interfaced to the module, if any.

Note: For technical support calls within the United States, ProSoft's 24/7 after-hours phone support is available for urgent plant-down issues. Detailed contact information for all our worldwide locations is available on the following page.

Internet	Web Site: www.prosoft-technology.com/support E-mail address: support@prosoft-technology.com
Asia Pacific (location in Malaysia)	Tel: +603.7724.2080 E-mail: asiapc@prosoft-technology.com Languages spoken include: Chinese, English
Asia Pacific (location in China)	Tel: +86.21.5187.7337 x888 E-mail: asiapc@prosoft-technology.com Languages spoken include: Chinese, English
Europe (location in Toulouse, France)	Tel: +33 (0) 5.34.36.87.20 E-mail: support.EMEA@prosoft-technology.com Languages spoken include: French, English
Europe (location in Dubai, UAE)	Tel: +971-4-214-6911 E-mail: mea@prosoft-technology.com Languages spoken include: English, Hindi
North America (location in California)	Tel: +1.661.716.5100 E-mail: support@prosoft-technology.com Languages spoken include: English, Spanish
Latin America (Oficina Regional)	Tel: +1-281-2989109 E-Mail: latinam@prosoft-technology.com Languages spoken include: Spanish, English
Latin America (location in Puebla, Mexico)	Tel: +52-222-3-99-6565 E-mail: soporte@prosoft-technology.com Languages spoken include: Spanish
Brasil (location in Sao Paulo)	Tel: +55-11-5083-3776 E-mail: brasil@prosoft-technology.com Languages spoken include: Portuguese, English

7.2 Warranty Information

For complete details regarding ProSoft Technology's TERMS & CONDITIONS OF SALE, WARRANTY, SUPPORT, SERVICE AND RETURN MATERIAL AUTHORIZATION INSTRUCTIONS please see the documents on the ProSoft Solutions DVD or go to www.prosoft-technology.com/legal
Documentation is subject to change without notice.

Index

1

1x • 45

A

About the ICX30-HWC Industrial Cellular Gateway • 7
Adding a 1756-ENBT to the Project • 48
Administrator • 35
Advanced Setup • 27
Analog Input • 34
Antenna Installation • 37
Assigning an IP Address to the ICX30-HWC • 15

B

Backup • 36

C

CDMA Communication (Verizon®) • 45
Configuration Webpage • 13, 21
Configuration Webpage Setup • 14
Connecting the Radio to a Network Device • 38
Connecting to your Cellular Provider • 17
Contacting Technical Support • 61
Content Disclaimer • 2
Creating a New RSLogix 5000 Project • 47

D

Digital I/O • 34
Dynamic DNS • 28

E

EDGE • 44
Electrical Specification of I/O Terminals • 39
Ethernet Bridge Network Setup • 50
Ethernet Cable Configuration • 40
Ethernet Cable Specifications • 40
Ethernet/IP Support • 47
EV-DO • 45

F

Firmware Update • 36

G

General • 36
GPRS • 44
GRE Tunnel • 32
GSM Communication (AT&T®) • 43

H

Hardware Installation • 37
HSDPA • 43
HSUPA • 43

I

I/O Terminal • 38
ICX30.CONTROL • 56
ICX30.GPS • 58
ICX30.IO • 58
ICX30.SMS • 57
ICX30.STATUS • 57
ICX30.UTIL • 59
ICX30-HWC Controller Tags • 56
Important Notice • 4
Important Safety Information • 3
Importing the AOI • 53

L

LAN Configuration • 26
LED Indicators • 42
Limitation of Liability • 4
Logs • 36

M

MAC Filtering • 28

N

Network Interface • 24
NTP • 35

P

Package Contents • 10
Password • 35
Ping • 36
Pinouts • 10, 40
Port Forward • 28
Power Requirements • 11

S

Security • 46
Serial Port • 29
Serial Port Basics • 41
SNMP • 28
Specifications • 9
Start Here • 7
Status • 22
Steps of a connection using CDMA (where applicable):
• 20
Steps of a connection using GSM/GPRS • 17
Support, Service & Warranty • 61
System Requirements • 10

U

UMTS • 44

V

- VPN Tunnel (IPSEC) • 31
- VPN Tunnel (Open VPN) • 31

W

- WAN Configuration • 24
- Warranty Information • 62

Y

- Your Feedback Please • 2