



Where Automation Connects.



inRAX[®]

MVI46-BDW

SLC Platform

BARDAC Drive Web Interface

September 04, 2008

USER MANUAL

Please Read This Notice

Successful application of this module requires a reasonable working knowledge of the Rockwell Automation SLC hardware, the MVI46-BDW Module and the application in which the combination is to be used. For this reason, it is important that those responsible for implementation satisfy themselves that the combination will meet the needs of the application without exposing personnel or equipment to unsafe or inappropriate working conditions.

This manual is provided to assist the user. Every attempt has been made to ensure that the information provided is accurate and a true reflection of the product's installation requirements. In order to ensure a complete understanding of the operation of the product, the user should read all applicable Rockwell Automation documentation on the operation of the Rockwell Automation hardware.

Under no conditions will ProSoft Technology be responsible or liable for indirect or consequential damages resulting from the use or application of the product.

Reproduction of the contents of this manual, in whole or in part, without written permission from ProSoft Technology is prohibited.

Information in this manual is subject to change without notice and does not represent a commitment on the part of ProSoft Technology Improvements and/or changes in this manual or the product may be made at any time. These changes will be made periodically to correct technical inaccuracies or typographical errors.

Battery Life Advisory

All modules in the MVI series use a rechargeable Lithium Vanadium Pentoxide battery to backup the 512K SRAM memory, real-time clock, and CMOS. The battery should last for the life of the module.

The module must be powered for approximately twenty hours before it becomes fully charged. After it is fully charged, the battery provides backup power for the CMOS setup and configuration data, the real-time clock, and the 512K SRAM memory for approximately 21 days.

Before you remove a module from its power source, ensure that the battery within the module is fully charged. A fully charged battery will hold the BIOS settings (after being removed from its power source) for a limited number of days. When the battery is fully discharged, the module will revert to the default BIOS settings.

Note: The battery is not user replaceable.

Your Feedback Please

We always want you to feel that you made the right decision to use our products. If you have suggestions, comments, compliments or complaints about the product, documentation or support, please write or call us.

ProSoft Technology

1675 Chester Avenue, Fourth Floor
Bakersfield, CA 93301
+1 (661) 716-5100
+1 (661) 716-5101 (Fax)
<http://www.prosoft-technology.com>

Copyright © ProSoft Technology, Inc. 2000 - 2008. All Rights Reserved.

MVI46-BDW User Manual
September 04, 2008

ProSoft Technology®, ProLinX®, inRAx®, ProTalk® and RadioLinX® are Registered Trademarks of ProSoft Technology, Inc.

ProSoft® Product Documentation

In an effort to conserve paper, ProSoft Technology no longer includes printed manuals with our product shipments. User Manuals, Datasheets, Sample Ladder Files, and Configuration Files are provided on the enclosed CD and are available at no charge from our web site: <http://www.prosoft-technology.com>
Printed documentation is available for purchase. Contact ProSoft Technology for pricing and availability.

Asia Pacific: +603.7724.2080

Europe, Middle East, Africa: +33.5.34.36.87.20

Latin America: +1.281.298.9109

North America: +1.661.716.5100

Contents

Please Read This Notice	2
Battery Life Advisory	2
Your Feedback Please.....	2
ProSoft® Product Documentation.....	3
Guide to the MVI46-BDW User Manual	7
1 Start Here	9
1.1 System Requirements	9
1.2 Package Contents	10
1.3 Install ProSoft Configuration Builder Software	10
1.4 Setting Jumpers	12
1.5 Install the Module in the Rack	12
1.6 Connect your PC to the Processor.....	14
1.7 Download the Sample Program to the Processor	15
1.8 Connect your PC to the Module	17
2 Module Configuration	19
2.1 Installing and Configuring the Module	19
2.2 Module Data	21
2.3 ProSoft Configuration Builder	21
2.4 Configuration File	26
2.5 Download the Project to the Module	31
3 Ladder Logic	33
4 Diagnostics and Troubleshooting	35
4.1 Reading Status Data from the Module	35
4.2 LED Status Indicators.....	46
5 Reference	49
5.1 Product Specifications.....	49
5.2 Functional Overview.....	51
5.3 Cable Connections	59
5.4 MVI46-BDW Status Data Definition	63
5.5 MVI46-BDW Configuration Data	66
6 Support, Service & Warranty	69
6.1 How to Contact Us: Technical Support	69

6.2	Return Material Authorization (RMA) Policies and Conditions	70
6.3	LIMITED WARRANTY	72
Index		77

Guide to the MVI46-BDW User Manual

Function		Section to Read	Details
Introduction (Must Do)	→	Start Here (page 9)	This Section introduces the customer to the module. Included are: package contents, system requirements, hardware installation, and basic configuration.
Verify Communication, Diagnostic and Troubleshooting	→	Verifying Communication (page 46) Diagnostics and Troubleshooting (page 35)	This section describes how to verify communications with the network. Diagnostic and Troubleshooting procedures.
Reference Product Specifications Functional Overview Glossary	→	Reference (page 49) Functional Overview (page 51) Product Specifications (page 49)	These sections contain general references associated with this product, Specifications, and the Functional Overview.
Support, Service, and Warranty Index	→	Support, Service and Warranty (page 69)	This section contains Support, Service and Warranty information. Index of chapters.

1 Start Here

In This Chapter

❖ System Requirements	9
❖ Package Contents	10
❖ Install ProSoft Configuration Builder Software.....	10
❖ Setting Jumpers	12
❖ Install the Module in the Rack	12
❖ Connect your PC to the Processor	14
❖ Download the Sample Program to the Processor.....	15
❖ Connect your PC to the Module	17

Installing the MVI46-BDW module requires a reasonable working knowledge of the Rockwell Automation hardware, the MVI46-BDW Module and the application in which they will be used.



Caution: It is important that those responsible for implementation can complete the application without exposing personnel, or equipment, to unsafe or inappropriate working conditions. Safety, quality and experience are key factors in a successful installation.

1.1 System Requirements

The MVI46-BDW module requires the following minimum hardware and software components:

- Rockwell Automation SLC 5/02 M0/M1 capable processors (or newer), with compatible power supply and one free slot in the rack, for the MVI46-BDW module. The module requires 800mA of available power.
- Rockwell Automation RSLogix 500 programming software.
- Rockwell Automation RSLinx communication software
- Pentium® II 500 MHz minimum. Pentium III 733 MHz (or better) recommended
- Supported operating systems:
 - Microsoft® Windows 98
 - Windows NT® (version 4 with SP4 or higher)
 - Windows 2000
 - Windows XP
- 32 Mbytes of RAM minimum, 64 Mbytes of RAM recommended
- 50 Mbytes of free hard disk space (or more based on application requirements)

- 16-color VGA graphics adapter, 640 x 480 minimum resolution (256 Color 800 × 600 recommended)
- CD-ROM drive
- 3.5 inch floppy disk drive
- HyperTerminal or other terminal emulator program capable of file transfers using Zmodem protocol.

1.2 Package Contents

The following components are included with your MVI46-BDW module, and are all required for installation and configuration.

Important: Before beginning the installation, please verify that all of the following items are present.

Qty.	Part Name	Part Number	Part Description
1	MVI46-BDW Module	MVI46-BDW	BARDAC Drive Web Interface
1	Cable	Cable #15, RS232 Null Modem	For RS232 Connection to the CFG Port
1	Cable	RJ45 to DB9 Male Adapter	For DB9 Connection to Module's Port
1	inRAX Solutions CD		Contains sample programs, utilities and documentation for the MVI46-BDW module.

If any of these components are missing, please contact ProSoft Technology Support for replacement parts.

1.3 Install ProSoft Configuration Builder Software

You must install the ProSoft Configuration Builder (PCB) software in order to configure the MVI46-BDW module. You can always get the newest version of ProSoft Configuration Builder from the ProSoft Technology web site.

To install ProSoft Configuration Builder from the ProSoft Web Site

- 1 Open your web browser and navigate to <http://www.prosoft-technology.com/pcb>
- 2 Click the **Download Here** link to download the latest version of ProSoft Configuration Builder.

- 3 Choose "Save" or "Save File" when prompted. The following illustrations show the file download prompt for two of the most common web browsers.



- 4 Make a note of the location where you saved the file, for example "Desktop", or "My Documents", so you can start the installation program.
- 5 When the download is complete, locate and open the file, and then follow the instructions on your screen to install the program.

If you do not have access to the Internet, you can install ProSoft Configuration Builder from the ProSoft Solutions CD-ROM, included in the package with your MVI46-BDW module.

To install ProSoft Configuration Builder from the CD-ROM

- 1 Insert the ProSoft Solutions CD-ROM into the CD drive of your PC. Wait for the startup screen to appear.
- 2 On the startup screen, click *Product Documentation*. This action opens an explorer window.
- 3 Click to open the *Utilities* folder. This folder contains all of the applications and files you will need to set up and configure your module.
- 4 Double-click the *ProSoft Configuration Builder Setup* program and follow the instructions on your screen to install the software on your PC.

Note: Many of the configuration and maintenance procedures use files and other utilities on the CD-ROM. You may wish to copy the files from the Utilities folder on the CD-ROM to a convenient location on your hard drive.

1.4 Setting Jumpers

Note: The Setup Jumper acts as "write protection" for the module's flash memory. In "write protected" mode, the Setup pins are not connected, and the module's firmware cannot be overwritten. Do not jumper the Setup pins together unless you are directed to do so by ProSoft Technical Support.

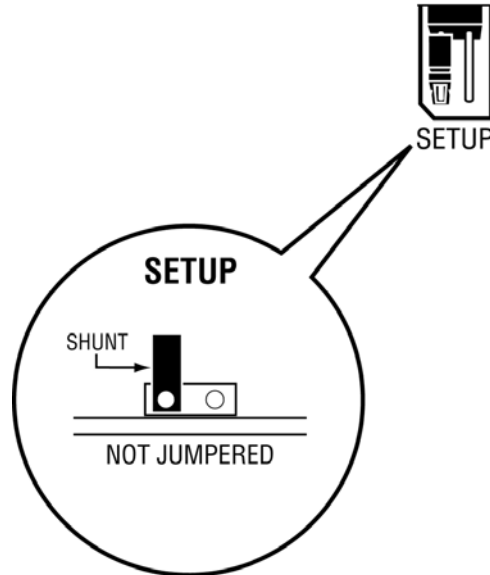

1.5 Install the Module in the Rack

If you have not already installed and configured your SLC processor and power supply, please do so before installing the MVI46-BDW module. Refer to your Rockwell Automation product documentation for installation instructions.

Warning: You must follow all safety instructions when installing this or any other electronic devices. Failure to follow safety procedures could result in damage to hardware or data, or even serious injury or death to personnel. Refer to the documentation for each device you plan to connect to verify that suitable safety procedures are in place before installing or servicing the device.

After you have checked the placement of the jumpers, insert MVI46-BDW into the SLC™ chassis. Use the same technique recommended by Rockwell Automation to remove and install SLC™ modules.

Warning: This module is not hot-swappable! Always remove power from the rack before inserting or removing this module, or damage may result to the module, the processor, or other connected devices.

- 1 Turn power OFF.

- 2 Align the module with the top and bottom guides, and slide it into the rack until the module is firmly against the backplane connector.

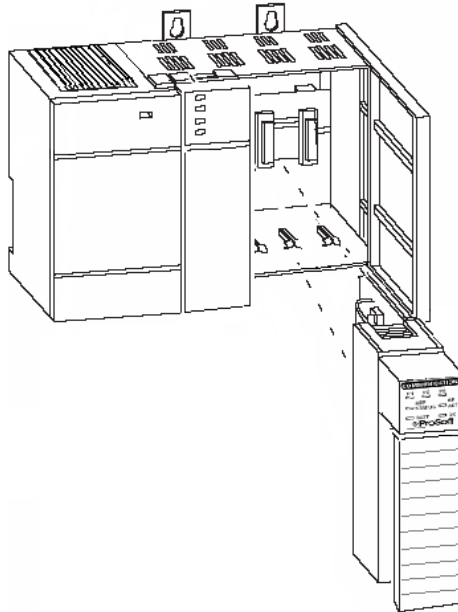

- 3 With a firm but steady push, snap the module into place.
- 4 Check that the holding clips on the top and bottom of the module are securely in the locking holes of the rack.
- 5 Make a note of the slot location. You will need to identify the slot in which the module is installed in order for the sample program to work correctly. Slot numbers are identified on the green circuit board (backplane) of the SLC rack.
- 6 Turn power ON.

Note: If you insert the module improperly, the system may stop working, or may behave unpredictably.

1.6 Connect your PC to the Processor

- 1 Connect the right-angle connector end of the cable to your controller at the communications port.

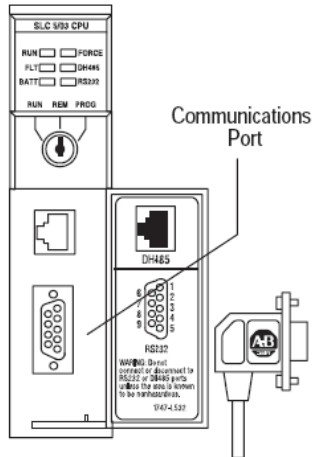

- 2 Connect the straight connector end of the cable to the serial port on your computer.

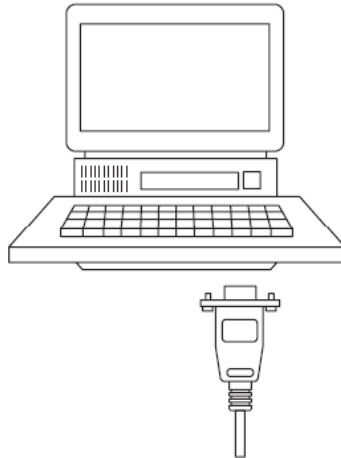

1.7 Download the Sample Program to the Processor

To download the sample program from RSLogix 500 to the SLC processor:

Note: The key switch on the front of the SLC processor must be in the REM position.

- 1 If you are not already online to the processor, open the Communications menu, and then choose Download. RSLogix will establish communication with the processor.

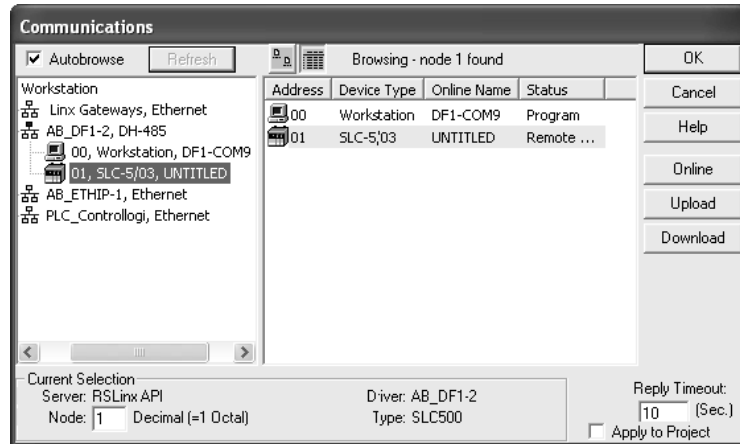

- 2 Click the Download button to transfer the sample program to the processor.
- 3 RSLogix will compile the program and transfer it to the processor. This process may take a few minutes.

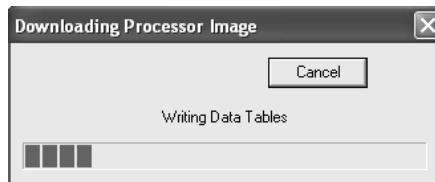

- 4 When the download is complete, RSLogix will open another confirmation dialog box. Click Yes to switch the processor from Program mode to Run mode.

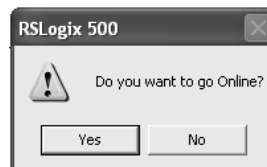

Note: If you receive an error message during these steps, refer to your RSLogix documentation to interpret and correct the error.

1.7.1 Configuring RSLinx

If RSLogix is unable to establish communication with the processor, follow these steps:

- 1 Open RSLinx.
- 2 Open the Communications menu, and choose Configure Drivers.

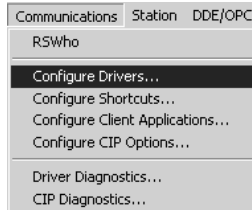

This action opens the Configure Drivers dialog box.

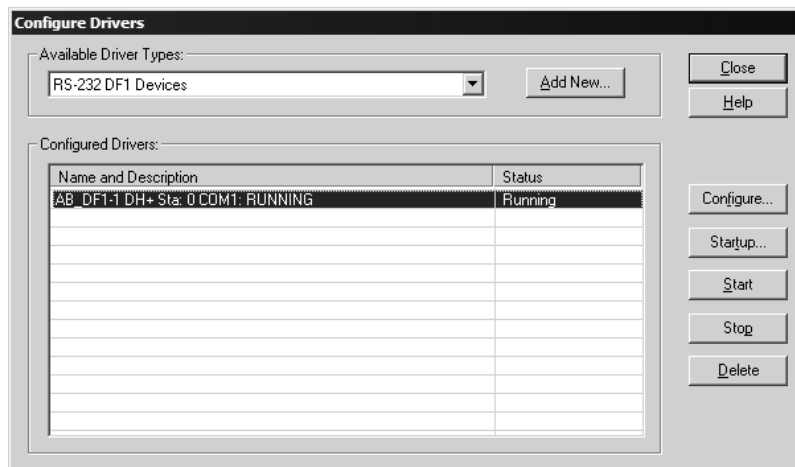

Note: If the list of configured drivers is blank, you must first choose and configure a driver from the Available Driver Types list. The recommended driver type to choose for serial communication with the processor is "RS-232 DF1 Devices".

- Click to select the driver, and then click Configure. This action opens the Configure Allen-Bradley DF1 Communications Device dialog box.



- Click the Auto-Configure button. RSLinx will attempt to configure your serial port to work with the selected driver.
- When you see the message "Auto Configuration Successful", click the OK button to dismiss the dialog box.

Note: If the auto-configuration procedure fails, verify that the cables are connected correctly between the processor and the serial port on your computer, and then try again. If you are still unable to auto-configure the port, refer to your RSLinx documentation for further troubleshooting steps.

1.8 Connect your PC to the Module

With the module securely mounted, connect your PC to the Configuration/Debug port using an RJ45-DB-9 Serial Adapter Cable and a Null Modem Cable.

- Attach both cables as shown.
- Insert the RJ45 cable connector into the Configuration/Debug port of the module.

- 3 Attach the other end to the serial port on your PC or laptop.

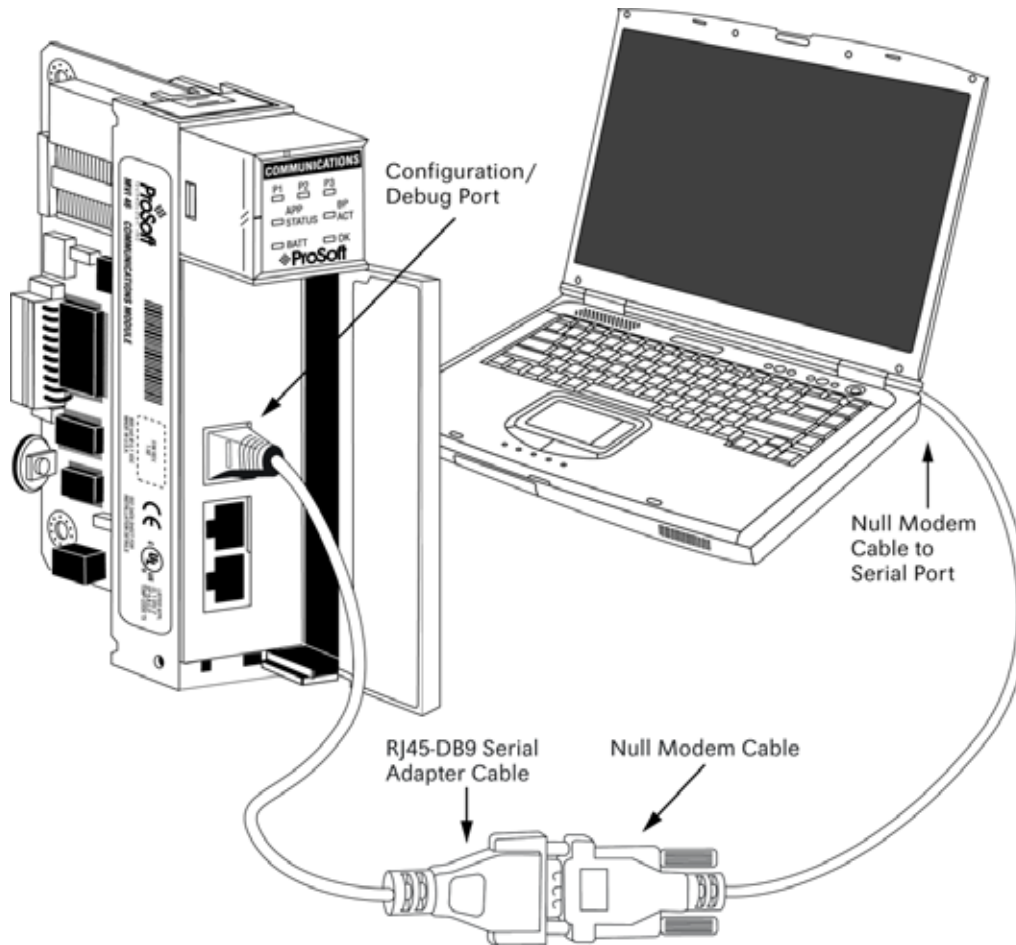

2 Module Configuration

In This Chapter

❖ Installing and Configuring the Module	19
❖ Module Data	21
❖ ProSoft Configuration Builder	21
❖ Configuration File	26
❖ Download the Project to the Module.....	31

This section contains the setup procedure, data, and ladder logic for successful application of the MVI46-BDW module. Each step in the setup procedure is defined in order to simplify the use of the module.

2.1 Installing and Configuring the Module

The configuration process consists of the following steps.

1 Download the sample program to the processor.

Note: For most applications, the sample program will work without modification. We strongly recommend setting up the module first with the sample program, before attempting to add the module to an existing application or create a custom application.

Modify the module's configuration files to meet the needs of your application, and copy the updated configuration to the module. Example configuration files are provided on the CD-ROM. Refer to *Modifying the Configuration File* (page 24) for more information on the configuration files.

First, define the module to the system. Select the I/O Configuration option from the program screen. The system displays the following window:

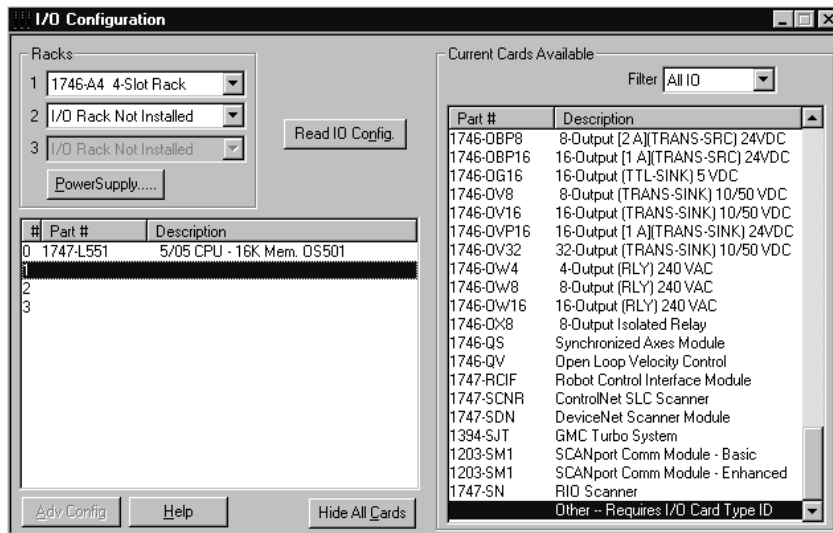

Select the Other module from the list. This causes the system to display the following dialog box:

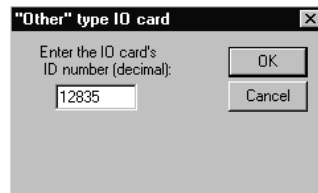

Enter the module I/O card ID number as 12835, and then click OK. Double-click the mouse on the module just added to the rack. Fill in the dialog box as shown:

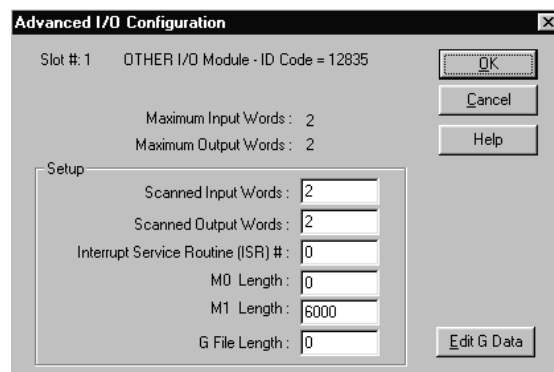

Next, define the user-defined data areas to hold the status and read and write database areas. Edit the BARDACDW.CFG file now for the application to implement. Use any text editor to set the values in the file. You must retain the file name BARDACDW.CFG.

The last step in the module setup is to add the ladder logic. If the example ladder logic is used, adjust the ladder to fit the application. When the ladder example is not used, copy the example ladder logic to your application and alter as necessary.

The module is now ready to be used with your application. Insert the module in the rack (with the power turned off) and attach the serial communication cables. Download the new BARDACDW.CFG file to the module using a terminal emulation program. Download the new application to the controller and place the processor in run mode. If all the configuration parameters are set correctly and the module is attached to a network, the module's Application LED (APP LED) should remain off and the backplane activity LED (BP ACT) should blink very rapidly. Refer to the Diagnostics and Troubleshooting section if you encounter errors. Attach a terminal to the Debug/Configuration port on the module and look at the status of the module using the Configuration/Debug Menu in the module.

2.2 Module Data

All data related to the MVI46-BDW module is stored in a user defined data files and the module's M1 file. Files should be defined for each data type to be used with the module. Additionally, a file should be defined to hold the module status data. The status data should be copied from the M1 file and placed in the assigned status file. Input (monitor) data should be copied from the user file to the M1 file and output (command) data should be copied from the user files to the M1 file.

2.3 ProSoft Configuration Builder

ProSoft Configuration Builder (PCB) provides a quick and easy way to manage module configuration files customized to meet your application needs. PCB is not only a powerful solution for new configuration files, but also allows you to import information from previously installed (known working) configurations to new projects.

2.3.1 Set Up the Project

To begin, start ProSoft Configuration Builder. If you have used other Windows configuration tools before, you will find the screen layout familiar. ProSoft Configuration Builder's window consists of a tree view on the left, an information pane and a configuration pane on the right side of the window. When you first start ProSoft Configuration Builder, the tree view consists of folders for Default Project and Default Location, with a Default Module in the Default Location folder. The following illustration shows the ProSoft Configuration Builder window with a new project.

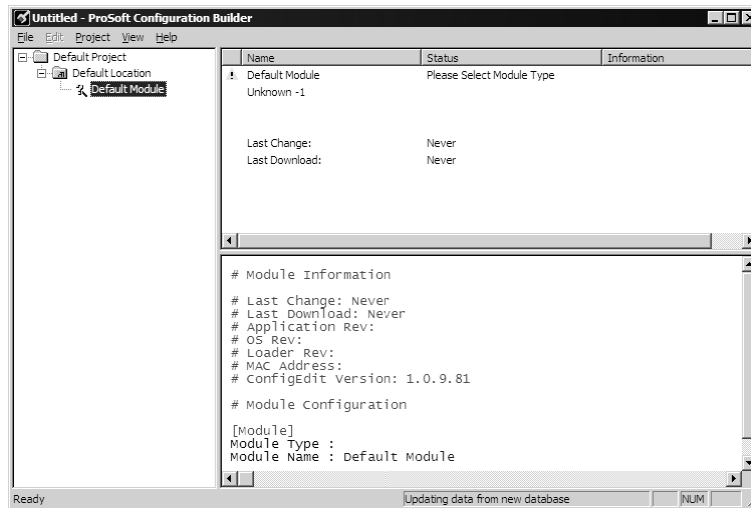

Your first task is to add the MVI46-BDW module to the project.

- 1 Use the mouse to select "Default Module" in the tree view, and then click the right mouse button to open a shortcut menu.

- On the shortcut menu, choose "Choose Module Type". This action opens the Choose Module Type dialog box.

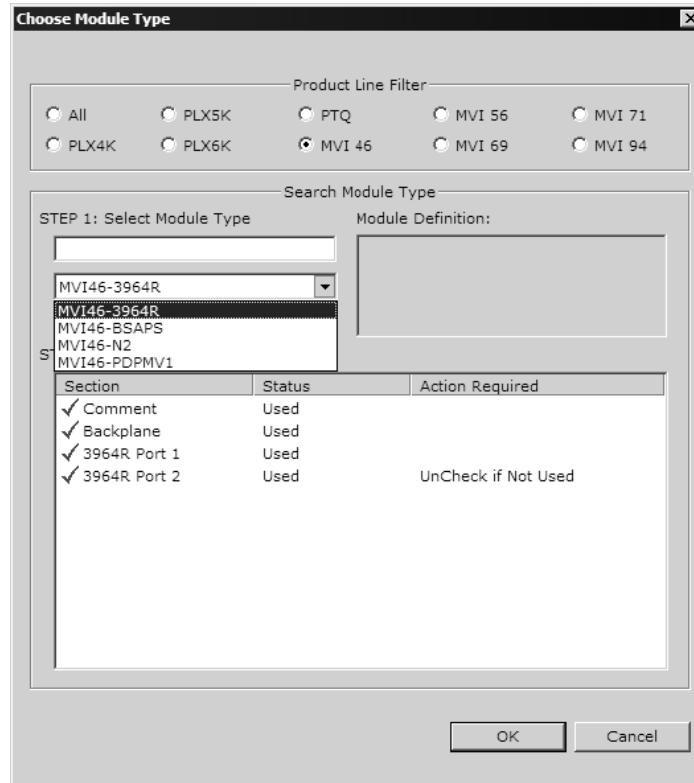

- In the Product Line Filter area of the dialog box, select MVI46. In the Select Module Type dropdown list, select MVI46-BDW, and then click OK to save your settings and return to the ProSoft Configuration Builder window.

The next task is to set the module parameters.

Adding a Module

To add a module to your project:

- Double-click the Default Module icon to open the Choose Module Type dialog box.
- On the Choose Module Type dialog box, select the module type.

Or

- Open the Project menu and choose Location.
- On the Location menu, choose Add Module.

To add a module to a different location:

- 1 Right-click the Location folder and choose Add Module. A new module icon appears.

Or

- 1 Select the Location icon.
- 2 From the Project menu, select Location, then select Add Module.

Adding a Project

To add a project to an existing project file:

- 1 Select the Default Project icon.
- 2 Choose Project from the Project menu, then choose Add Project. A new project folder appears.

2.3.2 Set Module Parameters

Notice that the contents of the information pane and the configuration pane changed when you added the MVI46-BDW module to the project.

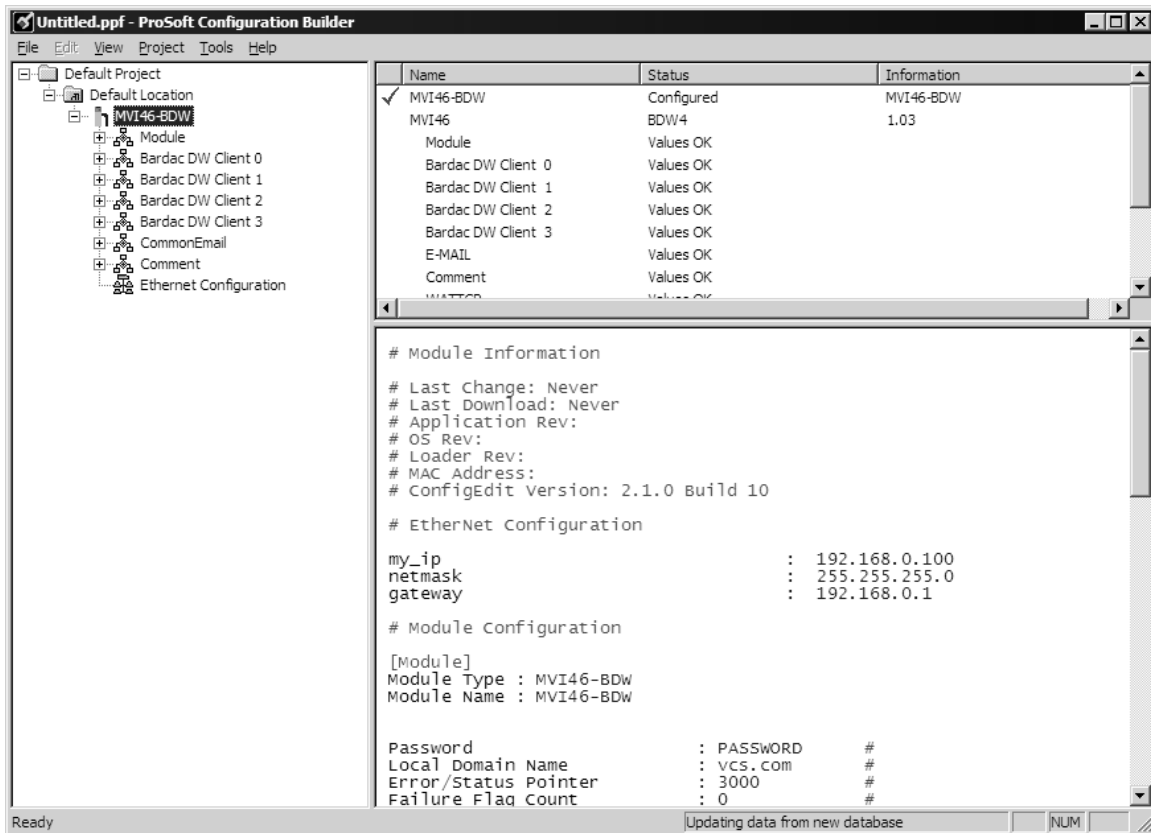



At this time, you may wish to rename the "Default Project" and "Default Location" folders in the tree view.



To rename an object:

- 1 Select the object, and then click the right mouse button to open a shortcut menu. From the shortcut menu, choose Rename.
- 2 Type the name to assign to the object.
- 3 Click away from the object to save the new name.

Module EntriesTo configure module parameters

- 1 Click on the plus sign next to the icon  Comment to expand module information.
- 2 Double-click the  Module Comment icon to open the Edit dialog box.
- 3 To edit a parameter, select the parameter in the left pane and make your changes in the right pane.
- 4 Click OK to save your changes.

Comment EntriesTo add comments to your configuration file:

- 1 Click the plus sign to the left of the  Comment icon to expand the Module Comments.
- 2 Double-click the  Module Comment icon. The Edit - Module Comment dialog appears.

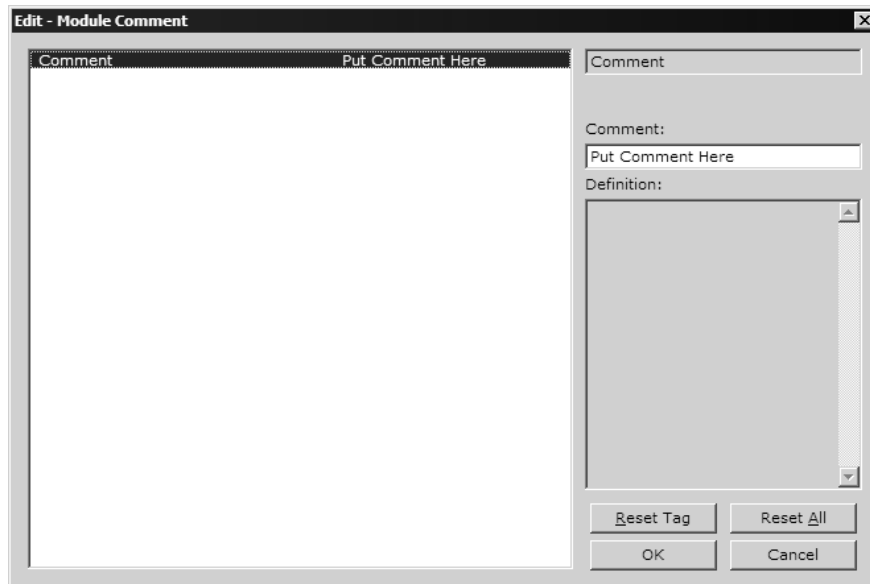

- 3 Enter your comment and click OK to save your changes.

Printing a Configuration File

To print a configuration file:

- 1 Select the Module icon, and then click the right mouse button to open a shortcut menu.
- 2 On the shortcut menu, choose View Configuration. This action opens the View Configuration window.
- 3 On the View Configuration window, open the File menu, and choose Print. This action opens the Print dialog box.
- 4 On the Print dialog box, choose the printer to use from the dropdown list, select printing options, and then click OK.

2.4 Configuration File

In order for the module to operate, a configuration file (BARDACDW.CFG) is required. This configuration file contains information to set the data transfer characteristics between the module and the processor, to configure the module's client and command list. Each parameter in the file must be set carefully in order for the application to be implemented successfully. The ProSoft Solutions CD contains an example listing of a BARDACDW.CFG file.

The configuration file is separated into sections with topic header names enclosed in the [] characters. The configuration file consists of the following sections:

[Section]	Description
[Module]	General module configuration information.
[BARDAC DW Client 0]	Configuration data for BARDAC DW Client 0
[BARDAC DW Client 0 Commands]	Command list for BARDAC DW Client 0
[BARDAC DW Client 1]	Configuration data for BARDAC DW Client 1
[BARDAC DW Client 1 Commands]	Command list for BARDAC DW Client 1
[BARDAC DW Client 2]	Configuration data for BARDAC DW Client 2
[BARDAC DW Client 2 Commands]	Command list for BARDAC DW Client 2
[BARDAC DW Client 3]	Configuration data for BARDAC DW Client 3
[BARDAC DW Client 3 Commands]	Command list for BARDAC DW Client 3

After each section header, the file contains a set of parameters. Unique labels are used under each section to specify a parameter. Each label in the file must be entered exactly as shown in the file for the parameter to be identified by the program. If the module is not considering a parameter, look at the label for the data item. Each parameter's value is separated from the label with the ':' character. This character is used by the program to delimit the position in the data record where to start reading data. All data for a parameter must be placed after the ':' character. For numeric parameter values any text located after the value will not be used. There must be at least one space character between the end of the parameter value and the following text. An example of a parameter entry is given below:

Error/Status Pointer: 3000 #Database location for Error/Status Data

The parameter label is "Error/Status Pointer" and the parameter value is 3000. The characters after the parameter value are ignored and are used for internal documentation of the configuration file.

Any record that begins with the '#' character is considered to be a comment record. These records can be placed anywhere in the file as long as the '#' character is found in the first column of the line. These lines are ignored in the file and can be used to provide documentation within the configuration file. Liberal use of comments within the file can ease the use and interpretation of the data in the file.

The client command list definition section is formatted differently than the other sections. This section contains lists of parameters to be used. Each list begins with the label **START** and when the **END** label is reached. When entering the records into the list, make certain that the first character in each line is left blank.

The [BARDAC DW CLIENT 0 COMMANDS] section defines the BARDAC DW commands to be issued from the module to server devices on the network. These commands can be used for data collection and/or control of devices on the UDP/IP network.

2.4.1 Command List Overview

In order to interface the MVI46-BDW module with UDP/IP server devices, you must construct a command list. The commands in the list specify the server device to be addressed, the function to be performed (read or write), the data area in the device to interface with, and the registers in the internal database to be associated with the device data. The Client command list supports up to 100 commands.

The command list is processed from top (command #0) to bottom. A poll interval parameter is associated with each command to specify a minimum delay time in tenths of a second between the issuance of a command. If the user specifies a value of 10 for the parameter, the command will be executed no more frequently than every 1 second.

Write commands have a special feature, as they can be set to execute only if the data in the write command changes. If the register data values in the command have not changed since the command was last issued, the command will not be executed.

If the data in the command has changed since the command was last issued, the command will be executed. Use of this feature can lighten the load on the network. In order to implement this feature; set the enable code for the command to a value of 2.

2.4.2 Commands Supported by the Module

The format of each command in the list is dependent on the BARDAC DW Function Code being executed. The tables below list the functions supported by the module:

Function Code	Definition	Supported in Client
0	Get (read data)	X
1	Set (write data)	X

Each command list record has the same general format. The first part of the record contains the information relating to the communication module and the second part contains information required to interface to the BARDAC DW UDP/IP server device.

2.4.3 Command Entry Formats

The following table shows the structure of the configuration data necessary for each of the supported commands:

BARDAC DW COMMAND STRUCTURE

Column #	1	2	3	4	5	6	10
Function Code	Enable Code	Internal Address	Poll Interval Time	Swap Code	IP Address	Function Code	Device Address
Get0	Code	Register	1/10 th Seconds	0	IP Address	0	Register
Set1	Code	Register	1/10 th Seconds	0	IP Address	1	Register

The first part of the record is the Module Information, which relates to the ProLinx module and the second part contains information required to interface to the Server device.

Command list example:

```
[BARDAC DW Client 0 Commands]
#
# 1 2 3 4 5 6 7
# DB Poll Swap Cmd Parameter
#Enab Addr Delay Code Node IP Address Code ID
START
 1 110 0 0 192.168.0.67 0 296
 1 111 0 0 192.168.0.67 0 181
 1 112 0 0 192.168.0.67 0 180
END
```

Parameter	Range	Description								
Enable	0,1,2	<p>This field defines whether or not the command is to be executed and under what conditions.</p> <table border="1"> <thead> <tr> <th>Value</th> <th>Description</th> </tr> </thead> <tbody> <tr> <td>0</td> <td>The command is disabled and will not be executed in the normal polling sequence.</td> </tr> <tr> <td>1</td> <td>The command is executed each scan of the command list if the Poll Interval Time is set to zero. If the Poll Interval time is set, the command will be executed, when the interval timer expires.</td> </tr> <tr> <td>2</td> <td>The command will execute only if the internal data associated with the command changes. This value is valid only for write commands.</td> </tr> </tbody> </table> <p>Because the BARDAC devices use the UDP protocol, the communication between the module and the device is not as reliable as with the TCP/IP protocol. For this reason, ProSoft suggests that the Enable Code of 2 not be used because a specific command may not be transferred. Therefore, it is strongly suggested to use the Enable Code of 1 to send SET commands.</p>	Value	Description	0	The command is disabled and will not be executed in the normal polling sequence.	1	The command is executed each scan of the command list if the Poll Interval Time is set to zero. If the Poll Interval time is set, the command will be executed, when the interval timer expires.	2	The command will execute only if the internal data associated with the command changes. This value is valid only for write commands.
Value	Description									
0	The command is disabled and will not be executed in the normal polling sequence.									
1	The command is executed each scan of the command list if the Poll Interval Time is set to zero. If the Poll Interval time is set, the command will be executed, when the interval timer expires.									
2	The command will execute only if the internal data associated with the command changes. This value is valid only for write commands.									
DB Address	0 to 4999	<p>This field specifies the internal database register to be associated with the command.</p> <p>- If the command is a read function, the data read from the Server device will be placed starting at the register value entered in this field.</p> <p>If the command is a write function, the data written to the Server device will be sourced from the address specified.</p> <p>The correct format depends on the parameter type. The following provides examples of the most common types:</p> <p>Time Secs (XX.X)</p> <p>PLC = 1 <=> BARDAC DRIVE = 0.1 sec</p> <p>PLC = 100 <=> BARDAC DRIVE = 10.0 sec</p> <p>PLC = 1019 <=> BARDAC DRIVE = 101.9 sec</p> <p>Percentage (X.XX)</p> <p>PLC = 1 <=> BARDAC DRIVE = 0.01%</p> <p>PLC = 10 <=> BARDAC DRIVE = 0.10%</p> <p>PLC = 10000 <=> BARDAC DRIVE = 100.00%</p> <p>ENABLED/DISABLED</p> <p>PLC = 0 <=> BARDAC = DISABLED</p> <p>PLC = 1 <=> BARDAC = ENABLED</p>								
Poll Delay	0 to 65535	<p>This parameter specifies the minimum interval to execute continuous commands (Enable code of 1). The parameter is entered in units of 1/10th seconds. Therefore, if a value of 10 is entered for a command, the command will execute no more frequently than every 1 second.</p>								

Parameter	Range	Description										
Swap Code	0,1,2,3	<p>This parameter is used only for functions 3, 4, 6, and 16 to define if the data received (or sent) from the module is to be ordered differently than data received from the server device. This parameter is helpful when dealing with floating-point or other multi-register values, as there is no standard method of storage of these data types in Server devices. This parameter can be set to order the register data received in an order useful by other applications. The following table defines the values and their associated operations:</p> <table border="1"> <thead> <tr> <th>Code</th> <th>Description</th> </tr> </thead> <tbody> <tr> <td>0</td> <td>None – No Change is made in the byte ordering</td> </tr> <tr> <td>1</td> <td>Words – The words are swapped</td> </tr> <tr> <td>2</td> <td>Words & Bytes – The words are swapped then the bytes in each word are swapped</td> </tr> <tr> <td>3</td> <td>Bytes – The bytes in each word are swapped</td> </tr> </tbody> </table> <p>When swapping words, make sure you are using an even value in the Count Field. Odd values may generate unexpected results.</p>	Code	Description	0	None – No Change is made in the byte ordering	1	Words – The words are swapped	2	Words & Bytes – The words are swapped then the bytes in each word are swapped	3	Bytes – The bytes in each word are swapped
Code	Description											
0	None – No Change is made in the byte ordering											
1	Words – The words are swapped											
2	Words & Bytes – The words are swapped then the bytes in each word are swapped											
3	Bytes – The bytes in each word are swapped											
Node IP Address	xxx.xxx.xxx.xx x	The IP address of the device being addressed by the command.										
Function Code	0 or 1	<p>This parameter specifies the function to be executed by the command. These function codes are defined in the BARDAC DW protocol.</p> <table border="1"> <thead> <tr> <th>Function Code</th> <th>Description</th> </tr> </thead> <tbody> <tr> <td>Get0</td> <td>Get (read data)</td> </tr> <tr> <td>Set1</td> <td>Set (write data)</td> </tr> </tbody> </table>	Function Code	Description	Get0	Get (read data)	Set1	Set (write data)				
Function Code	Description											
Get0	Get (read data)											
Set1	Set (write data)											
Parameter ID		This parameter specifies the PIN value for the data value or parameter to be considered by the command. Refer to the drive manual for a complete listing of valid PINs for your specific application.										

2.5 Download the Project to the Module

In order for the module to use the settings you configured, you must download (copy) the updated Project file from your PC to the module.

To Download the Project File

- 1 In the tree view in ProSoft Configuration Builder, click once to select the MVI46-BDW module.
- 2 Open the **Project** menu, and then choose **Module / Download**. The program will scan your PC for a valid com port (this may take a few seconds). When PCB has found a valid com port, the following dialog box will open.

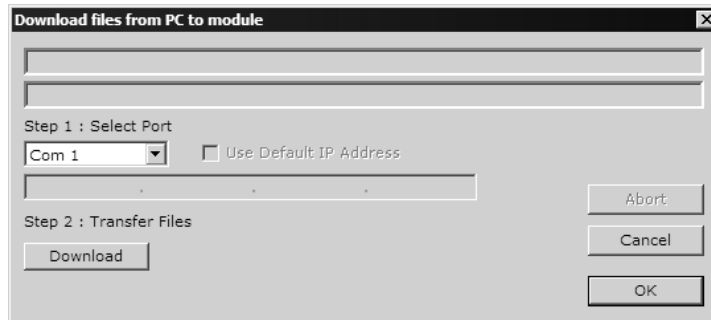

- 3 Choose the com port to use from the dropdown list, and then click the Download button.

The module will perform a platform check to read and load its new settings. When the platform check is complete, the status bar in ProSoft Configuration Builder will be updated with the message *"Module Running"*.

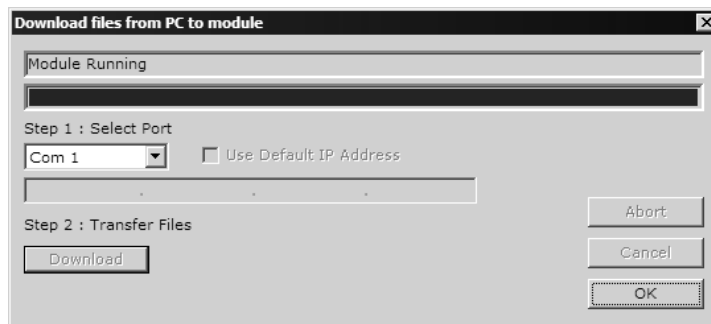

3 Ladder Logic

Ladder logic is required for application of the MVI46-BDW module. Tasks that must be handled by the ladder logic are module data transfer, special block handling and status data receipt. Additionally, a power-up handler may be needed to handle the initialization of the module's data and to clear any processor fault conditions.

The sample ladder logic, on the ProSoft Solutions CD-ROM, is extensively commented, to provide information on the purpose and function of each rung. For most applications, the sample ladder will work without modification.

4 Diagnostics and Troubleshooting

In This Chapter

- ❖ Reading Status Data from the Module 35
- ❖ LED Status Indicators..... 46

The module provides information on diagnostics and troubleshooting in the following forms:

- Status data values are transferred from the module to the processor.
- Data contained in the module can be viewed through the Configuration/Debug port attached to a terminal emulator.
- LED status indicators on the front of the module provide information on the module's status.

4.1 Reading Status Data from the Module

The MVI46-BDW module returns a Status Data block that can be used to determine the module's operating status. This data is located in the module's database at a user set location and is viewable using the Configuration/Debug port with a terminal emulation program. The Configuration/Debug port provides the following functionality:

- Full view of the module's configuration data
- View of the module's status data
- Complete display of the module's internal database (registers 0 to 3999)
- Version Information
- Control over the module (warm boot, cold boot, transfer configuration)
- Facility to upload and download the module's configuration file

4.1.1 Required Hardware

You can connect directly from your computer's serial port to the serial port on the module to view configuration information, perform maintenance, and send (upload) or receive (download) configuration files.

ProSoft Technology recommends the following minimum hardware to connect your computer to the module:

- 80486 based processor (Pentium preferred)
- 1 megabyte of memory
- At least one UART hardware-based serial communications port available. USB-based virtual UART systems (USB to serial port adapters) often do not function reliably, especially during binary file transfers, such as when uploading/downloading configuration files or module firmware upgrades.
- A null modem serial cable.

4.1.2 The Configuration/Debug Menu

The Configuration and Debug menu for this module is arranged as a tree structure, with the Main Menu at the top of the tree, and one or more sub-menus for each menu command. The first menu you see when you connect to the module is the Main menu.

Because this is a text-based menu system, you enter commands by typing the command letter from your computer keyboard in the diagnostic window in ProSoft Configuration Builder (PCB). The module does not respond to mouse movements or clicks. The command executes as soon as you press the command letter — you do not need to press **[Enter]**. When you type a command letter, a new screen will be displayed in your terminal application.

Using the Diagnostic Window in ProSoft Configuration Builder

To connect to the module's Configuration/Debug serial port:

- 1 Start PCB program with the application file to be tested. Right click over the module icon.

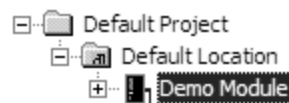

- 2 On the shortcut menu, choose Diagnostics.

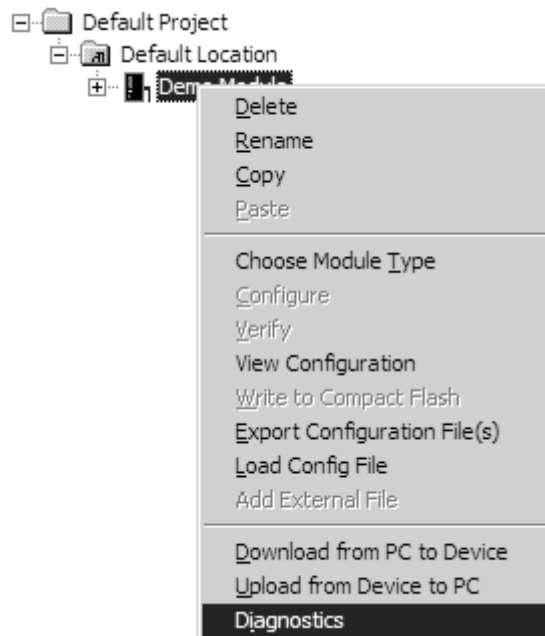

- This action opens the Diagnostics dialog box. Press "?" to display the Main Menu.

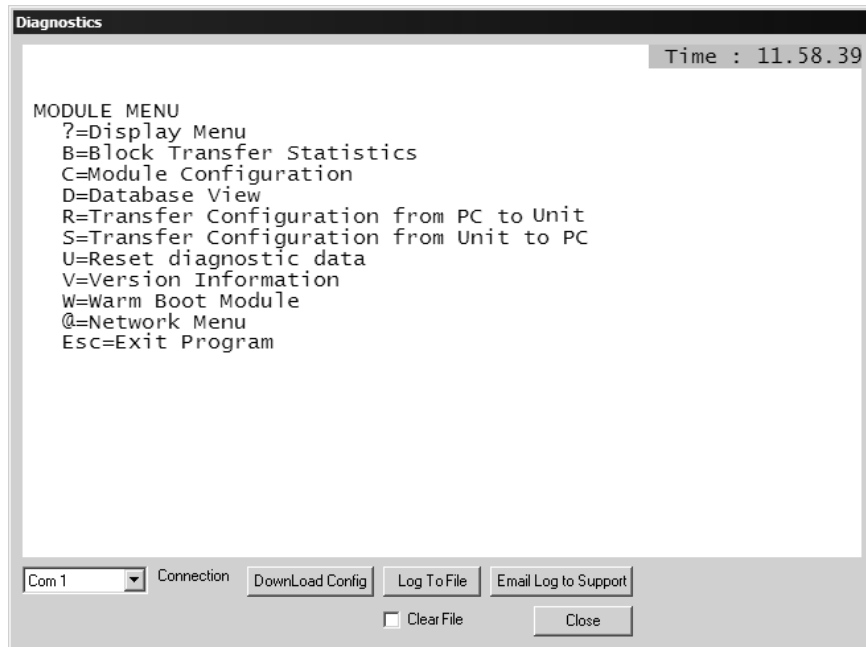

Important: The illustrations of configuration/debug menus in this section are intended as a general guide, and may not exactly match the configuration/debug menus in your own module.

If there is no response from the module, follow these steps:

- Verify that the null modem cable is connected properly between your computer's serial port and the module. A regular serial cable will not work.
- On computers with more than one serial port, verify that your communication program is connected to the same port that is connected to the module.

If you are still not able to establish a connection, contact ProSoft Technology for assistance.

Navigation

All of the sub-menus for this module contain commands to redisplay the menu or return to the previous menu. You can always return from a sub-menu to the next higher menu by pressing **[M]** on your keyboard.

The organization of the menu structure is represented in simplified form in the following illustration:

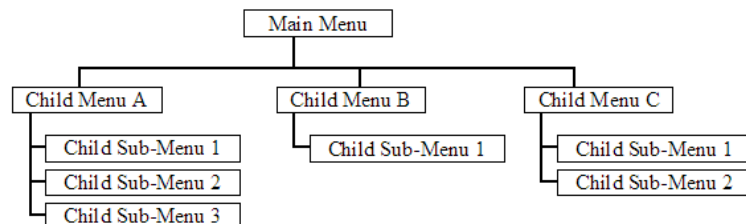

The remainder of this section shows you the menus available for this module, and briefly discusses the commands available to you.

Keystrokes

The keyboard commands on these menus are almost always non-case sensitive. You can enter most commands in lower case or capital letters.

The menus use a few special characters ([**?**], [**-**], [**+**], [**@**]) that must be entered exactly as shown. Some of these characters will require you to use the [**Shift**], [**Ctrl**] or [**Alt**] keys to enter them correctly. For example, on US English keyboards, enter the [**?**] command as [**Shift**]/.

Also, take care to distinguish capital letter [**I**] from lower case letter [**i**] (L) and number [**1**]; likewise for capital letter [**O**] and number [**0**]. Although these characters look nearly the same on the screen, they perform different actions on the module.

4.1.3 Main Menu

When you first connect to the module from your computer, your terminal screen will be blank. To activate the main menu, press the [**?**] key on your computer's keyboard. If the module is connected properly, the following menu will appear on your terminal screen:

```
MVI46-BARDAC DW COMMUNICATION MODULE MENU
?=Display Menu
B=Block Transfer Statistics
C=Module Configuration
D=Modbus Database View
Client Command List Errors:  E=0  F=1  G=2  H=3
Client Command List:       I=0  J=1  K=2  L=3
R=Transfer Configuration from PC to MUI Unit
S=Transfer Configuration from MUI Unit to PC
T=Display e-mail setup
U=Reset diagnostic data
V=Version Information
W=Warn Boot Module
Communication Status:  1=Client 0  2=Client 1  3=Client 2  4=Client 3
5=Client Configurations
@=Network Menu          Esc=Exit Program
```

Caution: Some of the commands available to you from this menu are designed for advanced debugging and system testing only, and can cause the module to stop communicating with the processor or with other devices, resulting in potential data loss or other failures. Only use these commands if you are specifically directed to do so by ProSoft Technology Technical Support staff. Some of these command keys are not listed on the menu, but are active nevertheless. Please be careful when pressing keys so that you do not accidentally execute an unwanted command.

Viewing Block Transfer Statistics

Press [**B**] from the Main Menu to view the Block Transfer Statistics screen.

Use this command to display the configuration and statistics of the backplane data transfer operations between the module and the processor. The information on this screen can help determine if there are communication problems between the processor and the module.

Tip: To determine the number of blocks transferred each second, mark the numbers displayed at a specific time. Then some seconds later activate the command again. Subtract the previous numbers from the current numbers and divide by the quantity of seconds passed between the two readings.

Viewing Module Configuration

Press **[C]** to view the Module Configuration screen.

Use this command to display the current configuration and statistics for the module.

Opening the Database Menu

Press **[D]** to open the Database View menu. Use this menu command to view the current contents of the module's database.

Opening the Command Error List Menu

Press **[E]**, **[F]**, **[G]** or **[H]** to open the Command Error List for clients 1 through 4 respectively. This list consists of multiple pages of command list error/status data. Press **[?]** to view a list of commands available on this menu.

Opening the Command List Menu

Press **[I]**, **[J]**, **[K]** or **[L]** to open the Command List menu for clients 1 through 4 respectively. Use this command to view the configured command list for the module.

Transferring the Configuration File from PC to MVI46 module

Press **[R]** to send (upload) the configuration file from your PC to the module and store the file on the module's Compact Flash Disk.

Press **[Y]** to confirm the file transfer, and then follow the instructions on the terminal screen to complete the file transfer process.

After the file has been successfully downloaded, the module will restart the program and load the new configuration information. Review the new configuration using menu commands **[6]** and **[0]** to verify that the module is configured correctly.

Transferring the Configuration File from MVI46 module to PC

Press **[S]** to receive (download) the configuration file from the module to your PC.

Press **[Y]** to confirm the file transfer, and then follow the instructions on the terminal screen to complete the file transfer process.

After the file has been successfully downloaded, you can open and edit the file to change the module's configuration.

Resetting diagnostic data

Press **[U]** to reset the status counters for the client and/or servers in the module.

Viewing Version Information

Press **[V]** to view Version information for the module.

Use this command to view the current version of the software for the module, as well as other important values. You may be asked to provide this information when calling for technical support on the product.

Values at the bottom of the display are important in determining module operation. The Program Scan Counter value is incremented each time a module's program cycle is complete.

Tip: Repeat this command at one-second intervals to determine the frequency of program execution.

Warm Booting the Module

Caution: Some of the commands available to you from this menu are designed for advanced debugging and system testing only, and can cause the module to stop communicating with the processor or with other devices, resulting in potential data loss or other failures. Only use these commands if you are specifically directed to do so by ProSoft Technology Technical Support staff. Some of these command keys are not listed on the menu, but are active nevertheless. Please be careful when pressing keys so that you do not accidentally execute an unwanted command.

Press **[W]** from the Main Menu to warm boot (restart) the module. This command will cause the program to exit and reload, refreshing configuration parameters that must be set on program initialization. Only use this command if you must force the module to re-boot.

Viewing Client Status

Press **[1]**, **[2]**, **[3]** or **[4]** to display the statistics of clients 1 through 4, respectively.

Opening the Network Menu

Press **[@]** to open the network menu. The network menu allows you to send, receive and view the WATTCP.CFG file that contains the IP, gateway and other network specification information. You can find more information about the commands on this menu in the Network Menu (page 45) section.

Opening the Network Menu

Press **[@]** to open the network menu. The network menu allows you to send, receive and view the WATTCP.CFG file that contains the IP, gateway and other network specification information. You can find more information about the commands on this menu in the Network Menu (page 45) section.

Exiting the Program

Caution: Some of the commands available to you from this menu are designed for advanced debugging and system testing only, and can cause the module to stop communicating with the processor or with other devices, resulting in potential data loss or other failures. Only use these commands if you are specifically directed to do so by ProSoft Technology Technical Support staff. Some of these command keys are not listed on the menu, but are active nevertheless. Please be careful when pressing keys so that you do not accidentally execute an unwanted command.

Press **[Esc]** to restart the module and force all drivers to be loaded. The module will use the configuration stored in the module's Flash ROM to configure the module.

4.1.4 Database View Menu

Press **[D]** from the Main Menu to open the Database View menu. Use this menu command to view the current contents of the module's database. Press **[?]** to view a list of commands available on this menu.

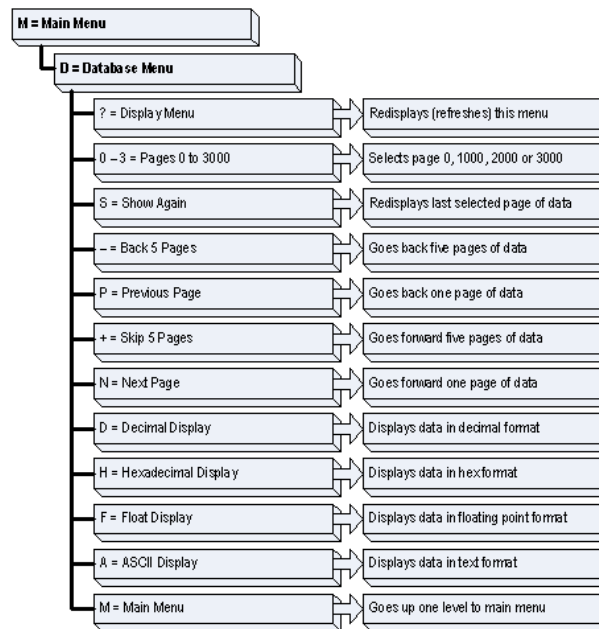

Viewing Register Pages

To view sets of register pages, use the keys described below:

Command	Description
[0]	Display registers 0 to 99
[1]	Display registers 1000 to 1099
[2]	Display registers 2000 to 2099

And so on. The total number of register pages available to view depends on your module's configuration.

Displaying the Current Page of Registers Again

DATABASE DISPLAY 0 TO 99 <DECIMAL>									
100	101	102	4	5	6	7	8	9	10
11	12	13	14	15	16	0	0	0	0
0	0	0	0	0	0	0	0	0	0
0	0	0	0	0	0	0	0	0	0
0	0	0	0	0	0	0	0	0	0
0	0	0	0	0	0	0	0	0	0
0	0	0	0	0	0	0	0	0	0
0	0	0	0	0	0	0	0	0	0
0	0	0	0	0	0	0	0	0	0
0	0	0	0	0	0	0	0	0	0

This screen displays the current page of 100 registers in the database.

Moving Back Through 5 Pages of Registers

Press **[-]** from the Database View menu to skip back to the previous 500 registers of data.

Viewing the Previous 100 Registers of Data

Press **[P]** from the Database View menu to display the previous 100 registers of data.

Skipping 500 Registers of Data

Hold down **[Shift]** and press **[=]** to skip forward to the next 500 registers of data.

Viewing the Next 100 Registers of Data

Press **[N]** from the Database View menu to select and display the next 100 registers of data.

Viewing Data in Decimal Format

Press **[D]** to display the data on the current page in decimal format.

Viewing Data in Hexadecimal Format

Press **[H]** to display the data on the current page in hexadecimal format.

Viewing Data in Floating Point Format

Press **[F]** from the Database View menu. Use this command to display the data on the current page in floating point format. The program assumes that the values are aligned on even register boundaries. If floating-point values are not aligned as such, they are not displayed properly.

Viewing Data in ASCII (Text) Format

Press **[A]** to display the data on the current page in ASCII format. This is useful for regions of the database that contain ASCII data.

Returning to the Main Menu

Press **[M]** to return to the Main Menu.

4.1.5 Master Command Error List Menu

Use this menu to view the command error list for the module. Press **[?]** to view a list of commands available on this menu.

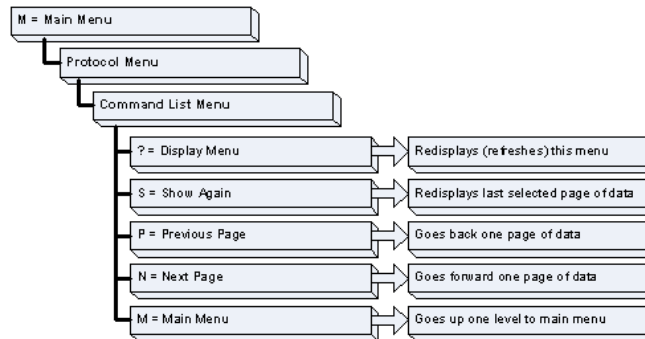

Redisplaying the Current Page

Press **[S]** to display the current page of data.

Viewing the Previous 20 Commands

Press **[-]** to display data for the previous 20 commands.

Viewing the Previous Page of Commands

Press **[P]** to display the previous page of commands.

Viewing the Next 20 Commands

Press **[+]** to display data for the next 20 commands.

Viewing the Next Page of Commands

Press **[N]** to display the next page of commands.

Returning to the Main Menu

Press **[M]** to return to the Main Menu.

4.1.6 Master Command List Menu

Use this menu to view the command list for the module. Press **[?]** to view a list of commands available on this menu.

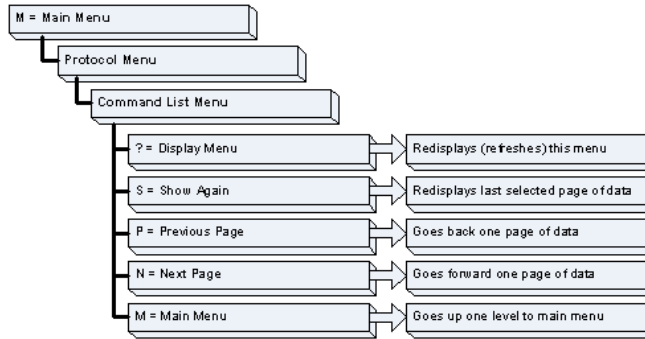

Redisplaying the Current Page

Press **[S]** to display the current page of data.

Viewing the Previous 50 Commands

Press **[-]** to view the previous 50 commands.

Viewing the Previous Page of Commands

Press **[P]** to display the previous page of commands.

Viewing the Next 50 Commands

Press **[+]** to view the next 50 commands from the master command list.

Viewing the Next Page of Commands

Press **[N]** to display the next page of commands.

Returning to the Main Menu

Press **[M]** to return to the Main Menu.

4.1.7 Network Menu

The network menu allows you to send, receive and view the WATTCP.CFG file that contains the IP and gateway addresses, and other network specification information.

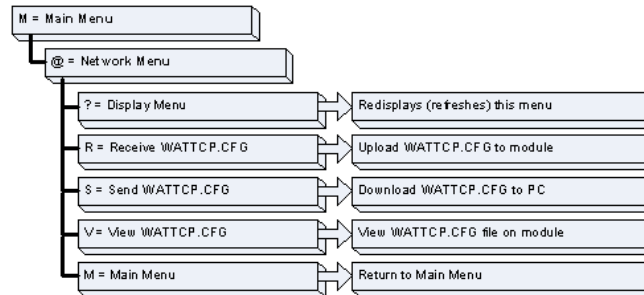

Transferring WATTCP.CFG to the module

Press **[R]** to transfer a new WATTCP.CFG file from the PC to the module. Use this command to change the network configuration for the module (for example, the module's IP address).

Press **[Y]** to confirm the file transfer, and then follow the instructions on the terminal screen to complete the file transfer process.

Transferring WATTCP.CFG to the PC

Press **[S]** to transfer the WATTCP.CFG file from the module to your PC.

Press **[Y]** to confirm the file transfer, and then follow the instructions on the terminal screen to complete the file transfer process.

After the file has been successfully transferred, you can open and edit the file to change the module's network configuration.

Viewing the WATTCP.CFG file on the module

Press **[V]** to view the module's WATTCP.CFG file. Use this command to confirm the module's current network settings.

```

Network Menu Selected
WATTCP.CFG FILE:
# ProLink Communication Gateways, Inc.
#
# Default private class 3 address
my_ip=192.168.0.135
#
# Default class 3 network mask
netmask=255.255.255.0
#
# The gateway I wish to use
gateway=192.168.0.1
#
#Parameters used by the ProLink Communication Gateways, Inc. module
#local_domain_name=mycompany.com
#password=PASSWORD
  
```

Returning to the Main Menu

Press **[M]** to return to the Main Menu.

4.2 LED Status Indicators

The LEDs indicate the module's operating status as follows:

ProSoft Module	Color	Status	Indication
CFG	Green	On	Data is being transferred between the module and a remote terminal using the Configuration/Debug port.
		Off	No data is being transferred on the Configuration/Debug port.
P1	Green	On	Port not used
		Off	Port not used
P2	Green	On	Port not used
		Off	Port not used
APP	Amber	Off	The MVI46-BDW is working normally.
		On	The MVI46-BDW module program has recognized a communication error on one of its Modbus ports.
BP ACT	Amber	On	The LED is on when the module is performing a write operation on the backplane.
		Off	The LED is off when the module is performing a read operation on the backplane. Under normal operation, the LED should blink rapidly on and off.
OK	Red/ Green	Off	The card is not receiving any power and is not securely plugged into the rack.
		Green	The module is operating normally.
		Red	The program has detected an error or is being configured. If the LED remains red for over 10 seconds, the program has probably halted. Remove the card from the rack and re-insert the card to restart the module's program.
BAT	Red	Off	The battery voltage is OK and functioning.
		On	The battery voltage is low or battery is not present. Allow battery to charge by keeping module plugged into rack for 24 hours. If BAT LED still does not go off, contact ProSoft Technology, as this is not a user serviceable item.

If a configuration error is found for the client, the client configuration error word will have a value other than zero. The configuration error word bits have the following definitions:

Bit	Description	Value
0		0x0001
1		0x0002
2		0x0004
3		0x0008
4	Invalid retry count parameter	0x0010
5	The float flag parameter is not valid.	0x0020
6	The float start parameter is not valid.	0x0040
7	The float offset parameter is not valid.	0x0080
8		0x0100
9		0x0200
10		0x0400

Bit	Description	Value
11		0x0800
12		0x1000
13		0x2000
14		0x4000
15		0x8000

Correct any invalid data in the configuration for proper module operation. When the configuration contains a valid parameter set, all the bits in the configuration word will be clear. This does not indicate that the configuration is valid for the user application. Make sure each parameter is set correctly for the specific application.

If the APP, BP ACT and OK LEDs blink at a rate of every one-second, this indicates a serious problem with the module. Call ProSoft Technology support to arrange for repairs.

4.2.1 Ethernet LED Indicators

LED	State	Description
Data	Off	No activity on the port.
	Green Flash	The port is either actively transmitting or receiving data.
Link	Off	No connection to hub or network is detected.
	Green Solid	Connected to hub or network correctly. This is the normal operating state.

4.2.2 Clearing a Fault Condition

Typically, if the OK LED on the front of the module turns red for more than ten seconds, a hardware problem has been detected in the module, or the program has exited.

To clear the condition, follow these steps:

- 1 Turn off power to the rack
- 2 Remove the card from the rack
- 3 Verify that all jumpers are set correctly
- 4 If the module requires a Compact Flash card, verify that the card is installed correctly
- 5 Re-insert the card in the rack and turn the power back on
- 6 Verify the configuration data being transferred to the module from the SLC processor.

If the module's OK LED does not turn green, verify that the module is inserted completely into the rack. If this does not cure the problem, contact ProSoft Technology Support.

4.2.3 Troubleshooting

Use the following troubleshooting steps if you encounter problems when the module is powered up. If these steps do not resolve your problem, please contact ProSoft Technology Technical Support.

Processor Errors

Problem Description	Steps to take
Processor Fault	Verify that the module is plugged into the slot that has been configured for the module. Verify that the slot in the rack configuration has been set up correctly in the ladder logic.
Processor I/O LED flashes	This indicates a problem with backplane communications. Verify that all modules in the rack are configured in the ladder logic.

Module Errors

Problem Description	Steps to take
BP ACT LED remains off or blinks slowly	This indicates that backplane transfer operations are failing. Connect to the module's Configuration/Debug port to check this. To establish backplane communications, verify the following items: <ul style="list-style-type: none">▪ The processor is in Run mode.▪ The backplane driver is loaded in the module.▪ The module is configured for read and write block data transfer.▪ The ladder logic handles all read and write block situations.▪ The module is configured in the processor.
OK LED remains red	The program has halted or a critical error has occurred. Connect to the Configuration/Debug port to see if the module is running. If the program has halted, turn off power to the rack, remove the card from the rack and re-insert the card in the rack, and then restore power to the rack.

5 Reference

In This Chapter

❖ Product Specifications	49
❖ Functional Overview	51
❖ Cable Connections	59
❖ MVI46-BDW Status Data Definition	63
❖ MVI46-BDW Configuration Data	66

5.1 Product Specifications

The MVI46 Bardac Drive Interface Module allows Rockwell Automation SLC I/O compatible processors to interface easily with Bardac drive.web devices.

5.1.1 Features and Benefits

The MVI46-BDW module acts as a client collecting and controlling data in a Bardac drive.web compatible device. Four independent clients are contained in the module to interface with Bardac drives simultaneously. The data is passed from the network to the SLC backplane. The data transfer from the SLC processor is asynchronous from the actions on the UDP/IP network. A 5000-word register space in the module exchanges data between the processor and the network.

5.1.2 General Specifications

- Single Slot - 1746 backplane compatible (Local or extended I/O rack only. Remote rack not supported)
- The module is recognized as an Input/Output module and has access to processor memory for data transfer between processor and module using M0/M1 files
- Ladder Logic is used for data transfer between module and processor. Sample ladder file included
- Configuration data obtained from configuration text file downloaded to module. Sample configuration file included

5.1.3 Hardware Specifications

Specification	Description
Backplane Current Load	800 ma @ 5V (from backplane)
Operating Temperature	0 to 60°C (32 to 140°F)
Storage Temperature	-40 to 85°C (-40 to 185°F)

Specification	Description
Relative Humidity	5% to 95% (non-condensing)
Shock	30g operational, 50g non-operational
Vibration	5 g from 10150 Hz
Processor	Compatible with Rockwell Automation SLC 5/02 M0/M1 capable processors or newer
LED indicators	Module status, Backplane transfer status, Application status, Serial activity (debug port), Ethernet link and activity, and error LED status
Debug/Configuration port (CFG)	
CFG Port (CFG)	RJ45 (DB-9M with supplied cable) RS-232 only No hardware handshaking
Configuration Connector	RJ45 RS-232 Connector (RJ45 to DB-9 cable shipped with unit)
Application Ports	
Ethernet Port (Ethernet Modules)	RJ45 Connector Link and activity LED indicators Electrical Isolation 1500 V rms at 50 Hz to 60 Hz for 60 s, applied as specified in section 5.3.2 of IEC 60950: 1991 Ethernet Broadcast Storm Resiliency = less than or equal to 5000 [ARP] frames-per-second and less than or equal to 5 minutes duration

5.1.4 Functional Specifications

A client configured as a Bardac master device on the MVI46-BDW module will actively issue Bardac-DW commands to other nodes on the Bardac-DW network. One hundred commands are supported for each client. The SLC processor can be programmed to control the activity on the client by actively selecting commands from the command list to execute, or issuing commands directly from the ladder logic.

Some of the general specifications include:

- Support for the storage and transfer of up to 5000 registers to/from the SLC processor's controller tags
- User-definable module memory usage
- Ability for the user to define commands to set or get parameters from the Bardac device
- 10/100 Base-T Ethernet compatible interface
- Supports up to 100 user-defined read or write commands that can be sent to a Bardac device
- Configurable parameters for the client include
 - Error/Status Pointer
 - Command Error Pointer
 - Response Timeout
 - Retry Count

5.2 Functional Overview

This section provides an overview of how the MVI46-BDW module transfers data using the BDW protocol. You should understand the important concepts in this chapter before you begin installing and configuring the module.

5.2.1 General Concepts

The following discussion explains several concepts that are important for understanding the operation of the MVI46-BDW module.

Module Power Up

On power up the module begins performing the following logical functions:

- 1 Initialize hardware components
- 2 Initialize SLC backplane driver
- 3 Test and clear all RAM
- 4 Read configuration for module from BARDACDW.CFG file on Compact Flash Disk
- 5 Initialize Module Register space
- 6 Enable Client Driver

After the module has received the configuration, the module will begin communicating with other nodes on the network, depending on the configuration.

Main Logic Loop

Upon completing the power up configuration process, the module enters an infinite loop that performs the functions shown in the following diagram.

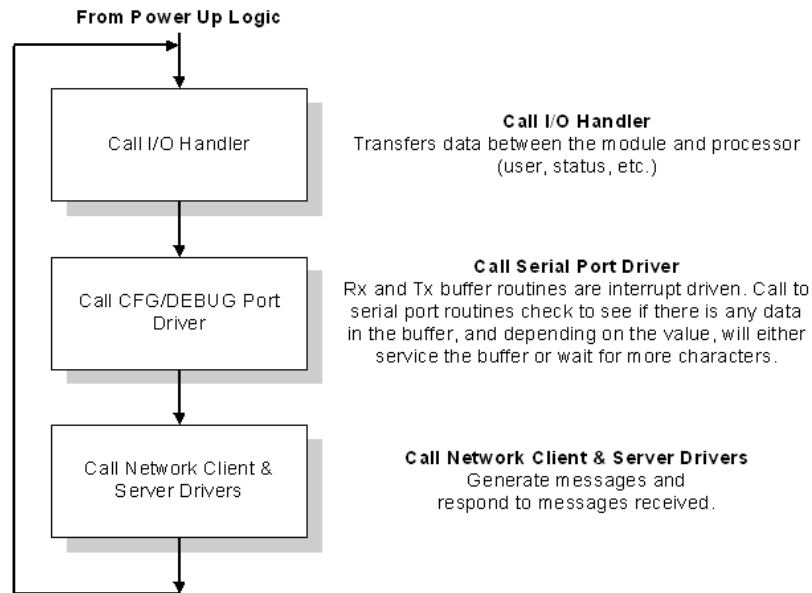

Backplane Data Transfer

The MVI46-BDW module communicates directly over the SLC backplane. All data for the module is contained in the module's M1 file. Data is moved between the module and the SLC processor across the backplane using the module's M1 file. The SLC scan rate and the communication load on the module determine the update frequency of the M1 file. The COP instruction can be used to move data between user data files and the module's M1 file.

The following illustration shows the data transfer method used to move data between the SLC processor, the MVI46-BDW module, and the BARDAC-DW Network.

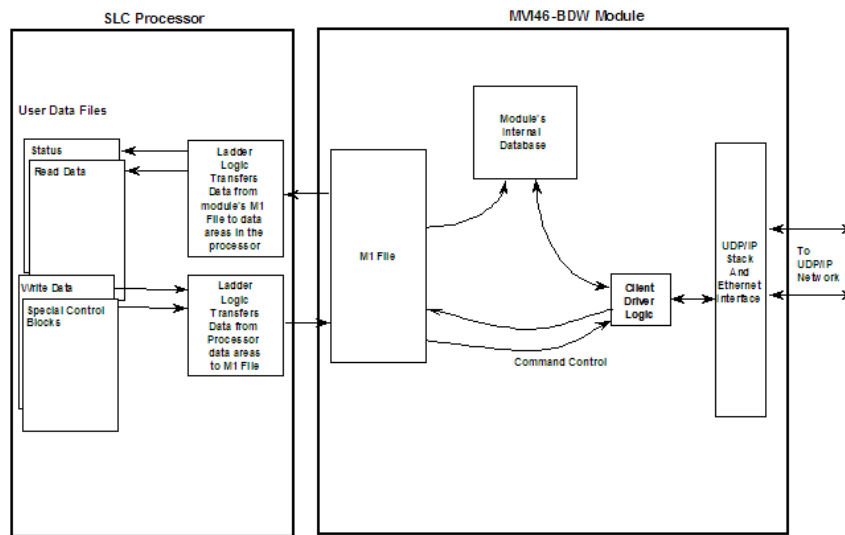

All data transferred between the module and the processor over the backplane is through the M1 file. Ladder logic must be written in the SLC processor to interface the M1 file data in the module's internal database. All data used by the module is stored in its internal database. This database is defined as a virtual data table with addresses from 0 (40001) to 4999 (45000). The following illustration shows the layout of the database:

Module's Internal Database Structure

5000 registers for user data

1000 registers for command control

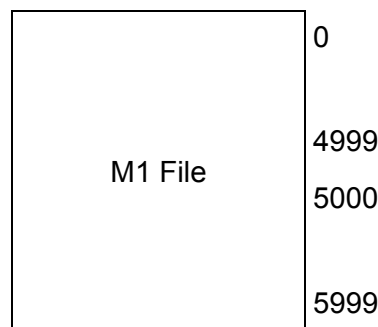

Data registers in the module above 4999 are used for command control. When special values are written in this register set, the module will perform specific functions. The following topics define the special functions handled by the module.

Initialize Output Data

When the module performs a restart operation, it will request output data from the processor to initialize the module's output data. Use the **Initialize Output Data** parameter in the configuration file to bring the module to a known state after a restart operation. The structure of the block used to request the data is displayed in the following table:

Offset	Description/Value	Length
5000	1000	1

The command control value of 1000 is placed in register 5000 of the M2 file to indicate that the module is requesting initialization of the M1 data file. Ladder logic in the processor must recognize this command and place the correct information in the M1file. After the data transfer is complete, the ladder logic should place a value of 1001 in register 5000 of the module's M1 file. The format of the returned write block is shown below:

Offset	Description/Value	Length
5000	1001	1

Command Control Blocks

Command control blocks are special blocks used to control the module. The current version of the software supports four command control blocks: event command control, command control, warm boot and cold boot. Register 5000 of the module's M1 file is used for this feature. The following table lists the command control block numbers recognized by the module.

Block Range	Descriptions
1000	Output Initialization Request from Module
1001	Output Initialization Complete
2000	Event Command
5001 to 5006	Command Control
9998	Warm Boot Control Block
9999	Cold Boot Control Block

Each of the command control blocks are discussed in the following topics.

Event Command

Event command control blocks send BARDAC-DW commands directly from the ladder logic to one of the clients on the module. The format for these blocks is displayed in the following table:

Offset	Description/Value	Length
5000	2000	1
5001 to 5004	IP Address	4
5005	Internal DB Address	1

Offset	Description/Value	Length
5006	Swap Code	1
5007	BARDAC DW Function Code	1
5008	Device Database Address	1
5009	Client Number (0 to 3)	1

The parameters passed with the block construct the command.

The **IP Address** for the node to reach on the network is entered in four registers (1 to 4). Each digit of the IP address is entered in the appropriate register. For example, to interface with node 192.168.0.100, enter the values 192, 168, 0 and 100 in registers 1 to 4.

The **Internal DB Address** parameter specifies the module's database location to associate with the command.

The **Swap Code** is used with functions 3 and 4 requests to change the word or byte order.

The **BARDAC DW Function Code** has one of the following values 1, 2, 3, 4, 5, 6, 15 or 16.

The **Device Database Address** is the register or point in the remote slave device to be associated with the command.

The **Client Number** is the designation of the specified client.

When the module receives the block, it will process it and place it in the command queue. A detailed description of the block is presented in the following table:

Word	Description
5000	This word contains the block 2000 identification code to indicate that this block contains a command to execute by the client driver.
5001 to 5004	These words contain the IP address for the server the message is intended for. Each digit (0 to 255) of the IP address is placed in one of the four registers. For example, to reach IP address 192.168.0.100, enter the following values in words 1 to 4...192, 168, 0, and 100. The module will construct the normal dotted IP address from the values entered. The values entered will be added with the mask 0x00ff to ensure the values are in the range of 0 to 255.
5005	This word contains the internal database address in the module to be used with the command. This word can contain a value from 0 to 4999.
5006	The parameter specifies the swap type for the data; 0 = Do not swap bytes, 1 = swap bytes.
5007	This word contains the BARDAC DW function code to be used with the command; 0 = Get function to retrieve data from unit and 1 = Set function to alter data in the unit.
5008	This word contains the PIN value for the data value or parameter to consider with the command. Refer to the drive manual for a complete list of all PIN values and their meaning.
5009	Client index used with the block. This parameter has a value from 0 to 3.

The module will respond to each event command block with a read block with the following format:

Word	Description
5000	Set to 0 on completion.
5001	This word contains the block identification code 2000 requested by the processor.
5002	This word contains the result of the event request. If a value of one is present, the command was issued. If a value of zero is present, no room was found in the command queue.
5003	Client index used with the block. This parameter has a value from 0 to 3.

Word two of the block can be used by the ladder logic to determine if the command was added to the command queue of the module. The command will only fail if the command queue for the port is full (100 commands for each queue).

Note: Because the BARDAC-DW devices use the UDP protocol, it is suggested that you use an additional GET command to verify if the value was accepted by the device (when a SET command is used).

Command Control

Command control blocks place commands from the command list into the command queue. The client has a command list of up to 100 commands. The module services commands in the queue before the user defined command list. This gives high priority to commands in the queue. Commands placed in the queue through this mechanism must be defined in the module's command list. Under normal command list execution, the module will only execute commands with the Enable parameter set to one or two. If the value is set to zero, the command is skipped. Commands may be placed in the command queue with an Enable parameter set to zero using this feature. These commands can then be executed using the command control blocks.

One to six commands can be placed in the command queue with a single request. The following table describes the format for this block.

Word	Description
5000	Command queue block identification code of 5001 to 5006.
5001	This word contains the index in the command list from the first command to be entered into the command queue.
5002	This word contains the index in the command list for the second command to be entered into the command queue.
5003	This word contains the index in the command list for the third command to be entered into the command queue.
5004	This word contains the index in the command list for the fourth command to be entered into the command queue.
5005	This word contains the index in the command list for the fifth command to be entered into the command queue.
5006	This word contains the index in the command list for the sixth command to be entered into the command queue.
5007	Client index used with the block. This parameter has a value from 0 to 3.

The last digit in the block code defines the number of commands to process in the block. For example, a block code of 5003 contains 3 command indexes that are to be placed in the command queue. The Command index parameters in the block have a range of 0 to 99 and correspond to the module's command list entries.

The module responds to a command control block with a block containing the number of commands added to the command queue for the port. The following table describes the format for this block.

Word	Description
5000	Set to 0 on completion.
5001	This word contains the block 5001 to 5006 requested by the processor.
5002	This word contains the number of commands in the block placed in the command queue.
5003	Client index used with the block. This parameter has a value from 0 to 3.

Note: Because the BARDAC-DW devices use the UDP protocol, it is suggested that you use an additional GET command to verify if the value was accepted by the device (when a SET command is used).

Warm Boot

This block is sent from the SLC processor to the module when the module is required to perform a warm-boot (software reset) operation. This block is commonly sent to the module any time configuration data modifications are made in the controller tags data area. This will force the module to read the new configuration information and to restart. The structure of the control block is shown in the following table:

Offset	Description/Value	Length
5000	9998	1

Cold Boot

This block is sent from the SLC processor to the module when the module is required to perform the cold boot (hardware reset) operation. This block is sent to the module when a hardware problem is detected by the ladder logic that requires a hardware reset. The structure of the control block is shown in the following table:

Offset	Description/Value	Length
5000	9999	1

5.2.2 Data Flow between MVI46-BDW Module and SLC Processor

The following topics describe the flow of data between the two pieces of hardware (SLC processor and MVI46-BDW module) and other nodes on the network under the module's different operating modes. The module contains four clients. The client can generate UDP requests to the BARDAC-DW device.

The following topics discuss the operation of the client drivers.

Client Driver

In the client driver, the MVI46-BDW module is responsible for issuing read or write commands to servers on the network. These commands are user configured in the module via the Client Command List received from the module's configuration file (BARDACDW.CFG) or issued directly from the SLC processor (event command control). Command status is returned to the processor for each individual command in the command list status block. The location of this status block in the module's internal database is user defined. The following flow chart and associated table describe the flow of data into and out of the module.

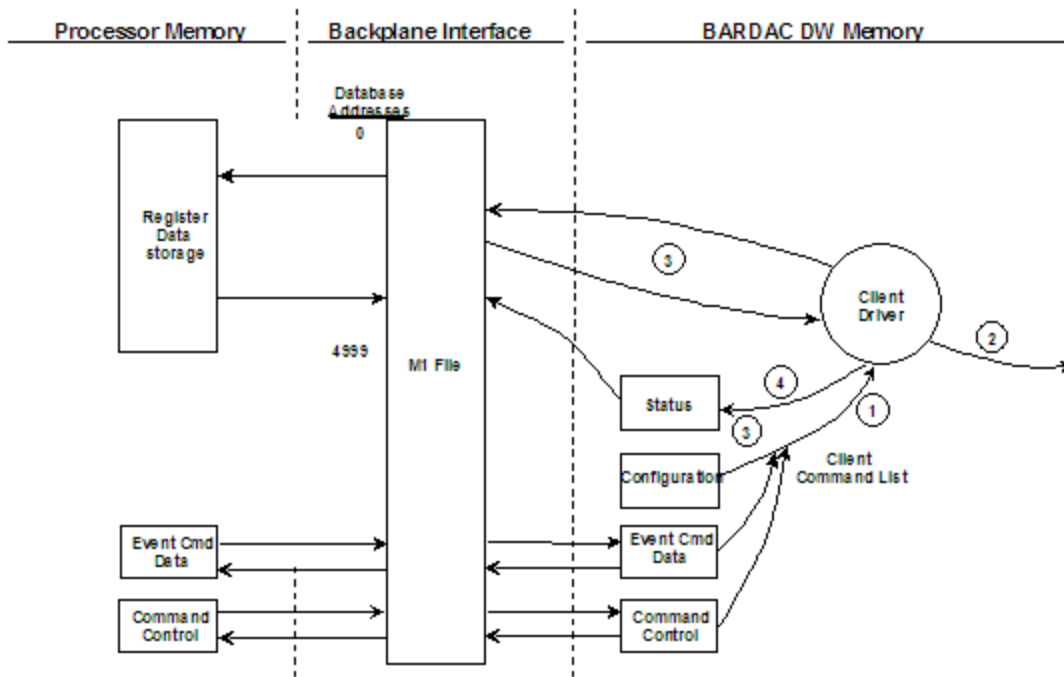

Step	Description
1	The client driver obtains configuration data from the BARDACDW.CFG file when the module restarts. The configuration data obtained includes the timeout parameters and the Command List. These values are used by the driver to determine the type of commands to be issued to the other nodes on the (see Module Configuration) network.
2	After configuration, the client driver begins transmitting read and/or write commands to the other nodes on the network. If writing data to another node, the data for the write command is obtained from the module's internal database to build the command.

Step	Description
3	Data received from the node on the network is passed into the module's internal database, assuming a read command.
4	Status data is returned to the SLC processor for the client and a Command List error table can be established in the module's internal database.

Client Command List

In order for the client to function, the module's Client Command List must be defined. This list contains up to 100 individual entries, with each entry containing the information required to construct a valid command. This includes the following:

- Command enable mode ((0) disabled, (1) continuous or (2) conditional)
- IP address and service port to connect to on the remote server
- Slave Node Address
- Command Type - Read or Write up to 100 words per command
- Database Source and Destination Register Address - Determines where data will be placed and/or obtained
- Count - Select the number of words to be transferred - 1 to 100
- Poll Delay (1/10th second)

Standard BARDAC DW PL/X Series Errors

Code	Description
0xA501	GET to invalid PIN
0xA702	SET to invalid PIN
0xA703	SET to read-only PIN
0xA704	SET to "restricted in run" PIN
0xA705	SET with out-of-range data
0xyy06	Setup source with invalid PIN
0xyy07	Setup source with invalid index
0xyy08	Setup destination with invalid PIN
0xyy09	Setup destination with invalid index
0xFFFFD	Device not ready (initializing)
0xFFFFE	Device lock timeout (serious problem with device)
0xFFFFF	Unable to obtain device lock (device servicing other transaction)
Others	Refer to drive manual or contact Bardac.

Standard BARDAC DW E-Series Errors

Code	Description
1	Illegal function
2	Illegal data address
3	Illegal data value
6	Busy, reject
7	Negative acknowledge
10	Read-only variable
11	Index out of range
12	Invalid data type

Code	Description
13	Invalid variable address
14	Invalid modbus address
15	Connection not setup
16	Write-only variable
17	EEPROM write fail
0xFFFFD	Device not ready (initializing)
0xFFFFE	Device lock timeout (serious problem with device)
0xFFFFF	Unable to obtain device lock (device servicing other transaction)
Others	Refer to drive manual or contact Bardac.

UDP Error Codes

Code	Description
0xFFDF	Could not find IP on network
0xFFDE	Buffer for UDP socket could not be allocated
0xFFDC	Command response timeout

Command List Entry Errors

Code	Description
40	Too few parameters for command
41	Invalid type code
42	Invalid internal database address
45	Invalid function code
46	Invalid swap code

5.3 Cable Connections

The MVI46-BDW module has the following communication connections on the module:

- One Ethernet port (RJ45 connector)
- One RS-232 Configuration/Debug port (RJ45 connector)

5.3.1 Ethernet Connection

The MVI46-BDW module has an RJ45 port located on the front of the module labeled "Ethernet", for use with the TCP/IP network. The module is connected to the Ethernet network using an Ethernet cable between the module's Ethernet port and an Ethernet switch or hub.

Note: Depending on hardware configuration, you may see more than one RJ45 port on the module. The Ethernet port is labeled "Ethernet".

Warning: The MVI46-BDW module is NOT compatible with Power Over Ethernet (IEEE802.3af / IEEE802.3at) networks. Do NOT connect the module to Ethernet devices, hubs, switches or networks that supply AC or DC power over the Ethernet cable. Failure to observe this precaution may result in damage to hardware, or injury to personnel.

Important: The module requires a static (fixed) IP address that is not shared with any other device on the Ethernet network. Obtain a list of suitable IP addresses from your network administrator BEFORE configuring the Ethernet port on this module.

Ethernet Port Configuration - wattcp.cfg

The wattcp.cfg file must be set up properly in order to use a TCP/IP network connection. You can view the current network configuration using an ASCII terminal by selecting "@" (Network Menu) and "V" (View) options when connected to the Debug port.

```
# WATTCP.CFG FILE:  
# ProSoft Technology.  
my_ip=192.168.0.100  
# Default class 3 network mask  
netmask=255.255.255.0  
# The gateway I wish to use  
gateway=192.168.0.1
```

5.3.2 RS-232 Configuration/Debug Port

This port is physically an RJ45 connection. An RJ45 to DB-9 adapter cable is included with the module. This port permits a PC based terminal emulation program to view configuration and status data in the module and to control the module. The cable for communications on this port is shown in the following diagram:

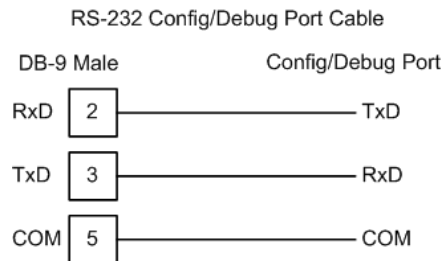

Disabling the RSLinx Driver for the Com Port on the PC

The communication port driver in RSLinx can occasionally prevent other applications from using the PC's COM port. If you are not able to connect to the module's configuration/debug port using ProSoft Configuration Builder (PCB), HyperTerminal or another terminal emulator, follow these steps to disable the RSLinx Driver.

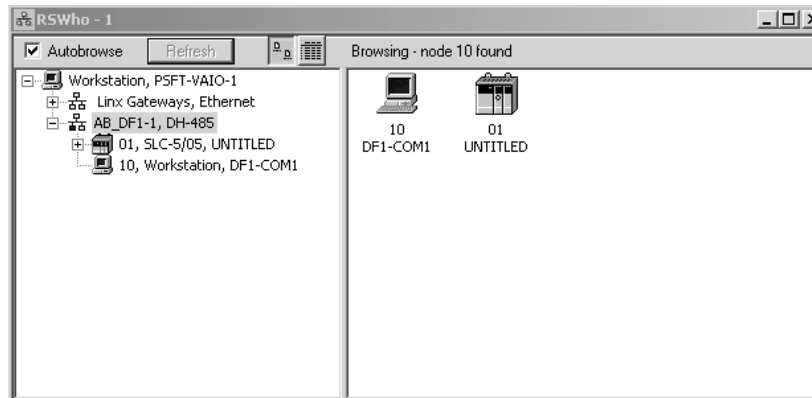

- 1 Open RSLinx and go to Communications>RSWho

- 2 Make sure that you are not actively browsing using the driver that you wish to stop. The following shows an actively browsed network:

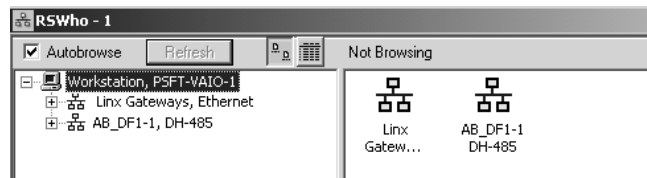

- 3 Notice how the DF1 driver is opened, and the driver is looking for a processor on node 1. If the network is being browsed, then you will not be able to stop this driver. To stop the driver your RSWWho screen should look like this:



Branches are displayed or hidden by clicking on the  or the  icons.

 AB_DF1-1, DH-485

- 4 When you have verified that the driver is not being browsed, go to **Communications>Configure Drivers**
You may see something like this:

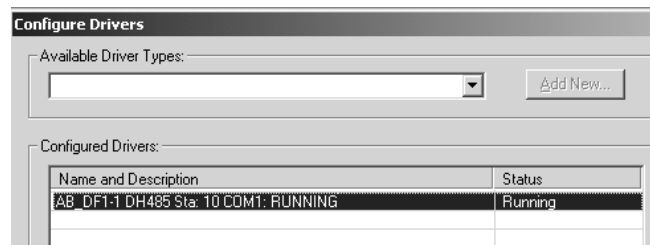

If you see the status as running, you will not be able to use this com port for anything other than communication to the processor. To stop the driver press the "Stop" on the side of the window:



5 After you have stopped the driver you will see the following:

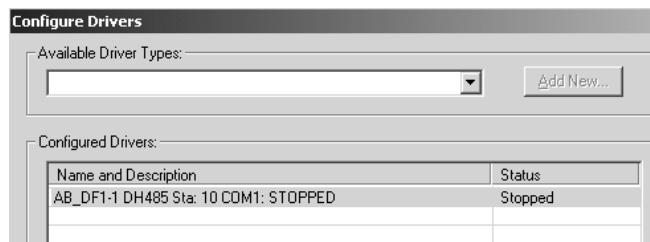

6 Upon seeing this, you may now use that com port to connect to the debug port of the module.

Note: You may need to shut down and restart your PC before it will allow you to stop the driver (usually only on Windows NT machines). If you have followed all of the above steps, and it will not stop the driver, then make sure you do not have RSLogix open. If RSLogix is not open, and you still cannot stop the driver, then reboot your PC.

5.3.3 DB9 to RJ45 Adaptor (Cable 14)

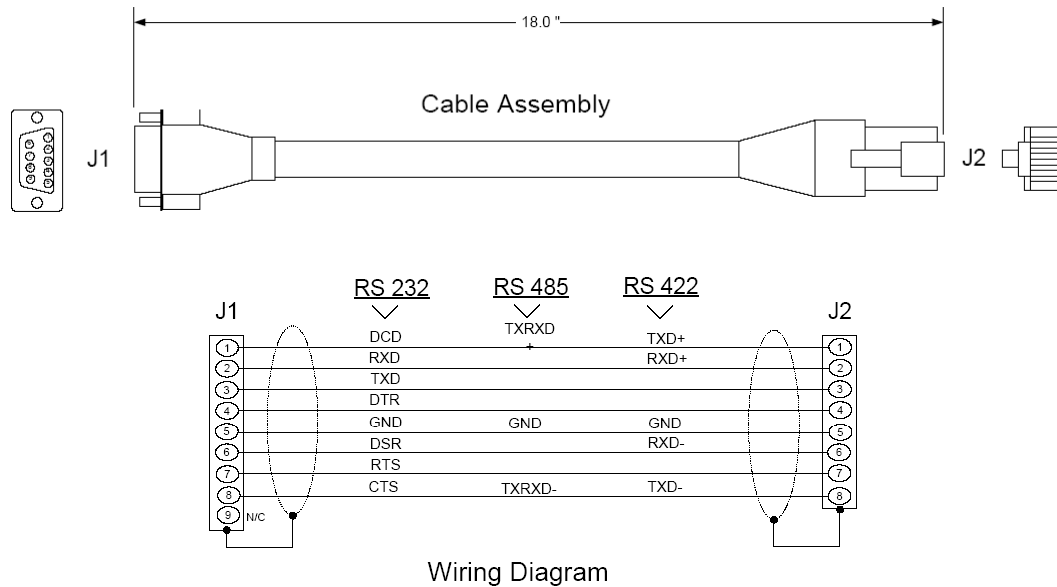

5.4 MVI46-BDW Status Data Definition

This section contains a description of the members present in the status data object. This data is transferred from the module to the processor as part of the read data area when the block transfer interface is used. When the side-connect interface is employed, this data set is automatically transferred to the user file by the module. This section also includes the [BARDAC DW Client 0] Error/Status Data table.

5.4.1 Error/Status Data Table

Module Data

Offset	Content	Description
0	Program Scan Count	This value is incremented each time a complete program cycle occurs in the module.
1	Read Block Count	This field contains the total number of read blocks transferred from the module to the processor.
2	Write Block Count	This field contains the total number of write blocks transferred from the processor to the module.
3	Parse Block Count	This field contains the total number of blocks successfully parsed that were received from the processor.
4	Command Event Block Count	This field contains the total number of command event blocks received from the processor.
5	Command Block Count	This field contains the total number of command blocks received from the processor.
6	Error Block Count	This field contains the total number of block errors recognized by the module.

Client 0

Offset	Content	Description
0	Client 0 Cmd Request	This value is incremented each time a command request is issued.
1	Client Cmd Response	This value is incremented each time a command response is received.
2	Client Cmd Error	This value is incremented each time an error message is received from a remote unit or a local error is generated for a command.
3	Client Request Count	This value is incremented each time a request message is issued.
4	Client Response Count	This value is incremented each time a response message is received.
5	Client Error Sent Count	This value is incremented each time an error is sent from the client.
6	Client Error Received Count	This value is incremented each time an error is received from a remote unit.
7	Client Cfg Error Word	This word contains a bit map that defines configuration errors in the configuration file for the client.
8	Client Current Error Code	This value corresponds to the current error code for the client.
9	Client Last Error Code	This value corresponds to the last error code recorded for the client.

Client 1

Offset	Content	Description
0	Client 1 Cmd Request	This value is incremented each time a command request is issued.
1	Client Cmd Response	This value is incremented each time a command response is received.
2	Client Cmd Error	This value is incremented each time an error message is received from a remote unit or a local error is generated for a command.
3	Client Request Count	This value is incremented each time a request message is issued.
4	Client Response Count	This value is incremented each time a response message is received.
5	Client Error Sent Count	This value is incremented each time an error is sent from the client.
6	Client Error Received Count	This value is incremented each time an error is received from a remote unit.
7	Client Cfg Error Word	This word contains a bitmap that defines configuration errors in the configuration file for the client.
8	Client Current Error Code	This value corresponds to the current error code for the client.
9	Client Last Error Code	This value corresponds to the last error code recorded for the client.

Client 2

Offset	Content	Description
0	Client 2 Cmd Request	This value is incremented each time a command request is issued.
1	Client Cmd Response	This value is incremented each time a command response is received.
2	Client Cmd Error	This value is incremented each time an error message is received from a remote unit or a local error is generated for a command.
3	Client Request Count	This value is incremented each time a request message is issued.
4	Client Response Count	This value is incremented each time a response message is received.
5	Client Error Sent Count	This value is incremented each time an error is sent from the client.
6	Client Error Received Count	This value is incremented each time an error is received from a remote unit.
7	Client Cfg Error Word	This word contains a bitmap that defines configuration errors in the configuration file for the client.
8	Client Current Error Code	This value corresponds to the current error code for the client.
9	Client Last Error Code	This value corresponds to the last error code recorded for the client.

Client 3

Offset	Content	Description
0	Client 3 Cmd Request	This value is incremented each time a command request is issued.
1	Client Cmd Response	This value is incremented each time a command response is received.
2	Client Cmd Error	This value is incremented each time an error message is received from a remote unit or a local error is generated for a command.
3	Client Request Count	This value is incremented each time a request message is issued.
4	Client Response Count	This value is incremented each time a response message is received.
5	Client Error Sent Count	This value is incremented each time an error is sent from the client.
6	Client Error Received Count	This value is incremented each time an error is received from a remote unit.
7	Client Cfg Error Word	This word contains a bitmap that defines configuration errors in the configuration file for the client.
8	Client Current Error Code	This value corresponds to the current error code for the client.
9	Client Last Error Code	This value corresponds to the last error code recorded for the client.

5.5 MVI46-BDW Configuration Data

This section contains a listing of the parameters and their definitions for the MVI46-BDW module configuration file definition.

[Section]/Item	Value	Range	Description
[MODULE]			Configuration header for general module information
Module Name:		Up to 80 chars	Name of the module for use on reports. Use this parameter to identify your module in your system.
Password:		Up to 20 chars	This parameter is used to set the password for the module. If the parameter is not set, the module will not be password protected. The module interprets the password as a case-sensitive string. Do not include spaces or special characters in the password. Only alpha and numeric characters should be used.
Error/Status Pointer:		-1 to 4955	Starting register location in virtual database for the error/status table. If a value of -1 is entered, the error/status data will not be placed in the database. All other valid values determine the starting location of the data. This data area includes the module version information and all server error/status data.
Write Register Start:		0 to 4999	This parameter specifies the starting register in the module where the data transferred from the processor will be placed. Valid range for this parameter is 0 to 4999.
Write Register Count:		0 to 5000	This parameter specifies the number of registers to transfer from the processor to the module. Valid entry for this parameter is 0 to 5000.
Read Register Start:		0 to 4999	This parameter specifies the starting register in the module where data will be transferred from the module to the processor. Valid range for this parameter is 0 to 4999.
Read Register Count:		0 to 5000	This parameter specifies the number of registers to be transferred from the module to the processor. Valid entry for this parameter is 0 to 5000.
Failure Flag Count:		0 to 65535	This parameter specifies the number of successive transfer errors that must occur before the communication ports are shut down. If the parameter is set to 0, the communication ports will continue to operate under all conditions. If the value is set larger than 0 (1 to 65535), communications will cease if the specified number of failures occur.
Initialize Output Data:		0 or 1	This parameter is used to determine if the output data for the module should be initialized with values from the processor. If the value is set to 0, the output data will be initialized to 0. If the value is set to 1, the data will be initialized with data from the processor. Use of this option requires associated ladder logic to pass the data from the processor to the module.

[Section]/Item	Value	Range	Description
[BARDAC DW CLIENT x]			Start header for Client x (x=0 to 3)
Error/Status Pointer:		-1 to 4990	Starting register location in virtual database for the error/status table for this client. If a value of -1 is entered, the error/status data will not be placed in the database. All other valid values determine the starting location of the data.
Minimum Command Delay:		0 to 65535	This parameter specifies the number of milliseconds to wait between the initial issuance of a command. This parameter can be used to delay all commands sent to slaves to avoid "flooding" commands on the network. This parameter does not affect retries of a command as they will be issued when failure is recognized.
Command Error Pointer:		-1 to 4999	This parameter sets the address in the internal database where the command error data will be placed. If the value is set to -1, the data will not be transferred to the database.
Response Timeout:		0 to 65535	This parameter represents the message response timeout period in 1-ms increments. This is the time that a client will wait before re-transmitting a command if no response is received from the addressed slave. The value is set depending upon the communication network used and the expected response time of the slowest device on the network.
Retry Count:		0 to 25	This parameter specifies the number of times a command will be retried if it fails.

The command list for the client in the module is located in the [] section of the file. The table below displays the functions supported by the module and the format of each command:

Module Information ← | → Device Information

BARDAC DW COMMAND STRUCTURE

Column #	1	2	3	4	5	6	7
Function Code	Enable Code	Internal Address	Poll Interval Time	Swap Code	IP Address	Function Code	Device Modbus Address
GET 0	Code	Register	1/10 Seconds	0	IP Address	0	Register
SET 1	Code	Register	1/10 Seconds	0	IP Address	1	Register

6 Support, Service & Warranty

In This Chapter

- ❖ How to Contact Us: Technical Support..... 69
- ❖ Return Material Authorization (RMA) Policies and Conditions..... 70
- ❖ LIMITED WARRANTY..... 72

ProSoft Technology, Inc. (ProSoft) is committed to providing the most efficient and effective support possible. Before calling, please gather the following information to assist in expediting this process:

- 1 Product Version Number
- 2 System architecture
- 3 Network details

If the issue is hardware related, we will also need information regarding:

- 1 Module configuration and contents of file
 - Module Operation
 - Configuration/Debug status information
 - LED patterns
- 2 Information about the processor and user data files as viewed through and LED patterns on the processor.
- 3 Details about the serial devices interfaced, if any.

6.1 How to Contact Us: Technical Support

Internet

Web Site: <http://www.prosoft-technology.com/support>
(<http://www.prosoft-technology.com/support>)

E-mail address: support@prosoft-technology.com
(<mailto:support@prosoft-technology.com>)

Asia Pacific

+603.7724.2080, support.asia@prosoft-technology.com
(<mailto:support.asia@prosoft-technology.com>)

Languages spoken include: Chinese, English

Europe (location in Toulouse, France)

+33 (0) 5.34.36.87.20, support.EMEA@prosoft-technology.com
(<mailto:support.emea@prosoft-technology.com>)

Languages spoken include: French, English

North America/Latin America (excluding Brasil) (location in California)

+1.661.716.5100, support@prosoft-technology.com (mailto:support@prosoft-technology.com)

Languages spoken include: English, Spanish

For technical support calls within the United States, an after-hours answering system allows pager access to one of our qualified technical and/or application support engineers at any time to answer your questions.

Brasil (location in Sao Paulo)

+55-11-5084-5178 , eduardo@prosoft-technology.com (mailto:eduardo@prosoft-technology.com)

Languages spoken include: Portuguese, English

6.2 Return Material Authorization (RMA) Policies and Conditions

The following RMA Policies and Conditions (collectively, "RMA Policies") apply to any returned Product. These RMA Policies are subject to change by ProSoft without notice. For warranty information, see "Limited Warranty". In the event of any inconsistency between the RMA Policies and the Warranty, the Warranty shall govern.

6.2.1 All Product Returns:

- a) In order to return a Product for repair, exchange or otherwise, the Customer must obtain a Returned Material Authorization (RMA) number from ProSoft and comply with ProSoft shipping instructions.
- b) In the event that the Customer experiences a problem with the Product for any reason, Customer should contact ProSoft Technical Support at one of the telephone numbers listed above (page 69). A Technical Support Engineer will request that you perform several tests in an attempt to isolate the problem. If after completing these tests, the Product is found to be the source of the problem, we will issue an RMA.
- c) All returned Products must be shipped freight prepaid, in the original shipping container or equivalent, to the location specified by ProSoft, and be accompanied by proof of purchase and receipt date. The RMA number is to be prominently marked on the outside of the shipping box. Customer agrees to insure the Product or assume the risk of loss or damage in transit. Products shipped to ProSoft using a shipment method other than that specified by ProSoft or shipped without an RMA number will be returned to the Customer, freight collect. Contact ProSoft Technical Support for further information.
- d) A 10% restocking fee applies to all warranty credit returns whereby a Customer has an application change, ordered too many, does not need, etc.

6.2.2 Procedures for Return of Units Under Warranty:

A Technical Support Engineer must approve the return of Product under ProSoft's Warranty:

- a) A replacement module will be shipped and invoiced. A purchase order will be required.
- b) Credit for a product under warranty will be issued upon receipt of authorized product by ProSoft at designated location referenced on the Return Material Authorization.

6.2.3 Procedures for Return of Units Out of Warranty:

- a) Customer sends unit in for evaluation
- b) If no defect is found, Customer will be charged the equivalent of \$100 USD, plus freight charges, duties and taxes as applicable. A new purchase order will be required.
- c) If unit is repaired, charge to Customer will be 30% of current list price (USD) plus freight charges, duties and taxes as applicable. A new purchase order will be required or authorization to use the purchase order submitted for evaluation fee.

The following is a list of non-repairable units:

- 3150 - All
- 3750
- 3600 - All
- 3700
- 3170 - All
- 3250
- 1560 - Can be repaired, only if defect is the power supply
- 1550 - Can be repaired, only if defect is the power supply
- 3350
- 3300
- 1500 - All

6.2.4 Purchasing Warranty Extension:

- a) ProSoft's standard warranty period is three (3) years from the date of shipment as detailed in "Limited Warranty (page 72)". The Warranty Period may be extended at the time of equipment purchase for an additional charge, as follows:
 - Additional 1 year = 10% of list price
 - Additional 2 years = 20% of list price
 - Additional 3 years = 30% of list price

6.3 LIMITED WARRANTY

This Limited Warranty ("Warranty") governs all sales of hardware, software and other products (collectively, "Product") manufactured and/or offered for sale by ProSoft, and all related services provided by ProSoft, including maintenance, repair, warranty exchange, and service programs (collectively, "Services"). By purchasing or using the Product or Services, the individual or entity purchasing or using the Product or Services ("Customer") agrees to all of the terms and provisions (collectively, the "Terms") of this Limited Warranty. All sales of software or other intellectual property are, in addition, subject to any license agreement accompanying such software or other intellectual property.

6.3.1 *What Is Covered By This Warranty*

- a) *Warranty On New Products:* ProSoft warrants, to the original purchaser, that the Product that is the subject of the sale will (1) conform to and perform in accordance with published specifications prepared, approved and issued by ProSoft, and (2) will be free from defects in material or workmanship; provided these warranties only cover Product that is sold as new. This Warranty expires three years from the date of shipment (the "Warranty Period"). If the Customer discovers within the Warranty Period a failure of the Product to conform to specifications, or a defect in material or workmanship of the Product, the Customer must promptly notify ProSoft by fax, email or telephone. In no event may that notification be received by ProSoft later than 39 months. Within a reasonable time after notification, ProSoft will correct any failure of the Product to conform to specifications or any defect in material or workmanship of the Product, with either new or used replacement parts. Such repair, including both parts and labor, will be performed at ProSoft's expense. All warranty service will be performed at service centers designated by ProSoft.
- b) *Warranty On Services:* Materials and labor performed by ProSoft to repair a verified malfunction or defect are warranted in the terms specified above for new Product, provided said warranty will be for the period remaining on the original new equipment warranty or, if the original warranty is no longer in effect, for a period of 90 days from the date of repair.

6.3.2 *What Is Not Covered By This Warranty*

- a) ProSoft makes no representation or warranty, expressed or implied, that the operation of software purchased from ProSoft will be uninterrupted or error free or that the functions contained in the software will meet or satisfy the purchaser's intended use or requirements; the Customer assumes complete responsibility for decisions made or actions taken based on information obtained using ProSoft software.

- b) This Warranty does not cover the failure of the Product to perform specified functions, or any other non-conformance, defects, losses or damages caused by or attributable to any of the following: (i) shipping; (ii) improper installation or other failure of Customer to adhere to ProSoft's specifications or instructions; (iii) unauthorized repair or maintenance; (iv) attachments, equipment, options, parts, software, or user-created programming (including, but not limited to, programs developed with any IEC 61131-3, "C" or any variant of "C" programming languages) not furnished by ProSoft; (v) use of the Product for purposes other than those for which it was designed; (vi) any other abuse, misapplication, neglect or misuse by the Customer; (vii) accident, improper testing or causes external to the Product such as, but not limited to, exposure to extremes of temperature or humidity, power failure or power surges; or (viii) disasters such as fire, flood, earthquake, wind and lightning.
- c) The information in this Agreement is subject to change without notice. ProSoft shall not be liable for technical or editorial errors or omissions made herein; nor for incidental or consequential damages resulting from the furnishing, performance or use of this material. The user guide included with your original product purchase from ProSoft contains information protected by copyright. No part of the guide may be duplicated or reproduced in any form without prior written consent from ProSoft.

6.3.3 Disclaimer Regarding High Risk Activities

Product manufactured or supplied by ProSoft is not fault tolerant and is not designed, manufactured or intended for use in hazardous environments requiring fail-safe performance including and without limitation: the operation of nuclear facilities, aircraft navigation or communication systems, air traffic control, direct life support machines or weapons systems in which the failure of the product could lead directly or indirectly to death, personal injury or severe physical or environmental damage (collectively, "high risk activities"). ProSoft specifically disclaims any express or implied warranty of fitness for high risk activities.

6.3.4 Intellectual Property Indemnity

Buyer shall indemnify and hold harmless ProSoft and its employees from and against all liabilities, losses, claims, costs and expenses (including attorney's fees and expenses) related to any claim, investigation, litigation or proceeding (whether or not ProSoft is a party) which arises or is alleged to arise from Buyer's acts or omissions under these Terms or in any way with respect to the Products. Without limiting the foregoing, Buyer (at its own expense) shall indemnify and hold harmless ProSoft and defend or settle any action brought against such Companies to the extent based on a claim that any Product made to Buyer specifications infringed intellectual property rights of another party. ProSoft makes no warranty that the product is or will be delivered free of any person's claiming of patent, trademark, or similar infringement. The Buyer assumes all risks (including the risk of suit) that the product or any use of the product will infringe existing or subsequently issued patents, trademarks, or copyrights.

- a) Any documentation included with Product purchased from ProSoft is protected by copyright and may not be duplicated or reproduced in any form without prior written consent from ProSoft.
- b) ProSoft's technical specifications and documentation that are included with the Product are subject to editing and modification without notice.
- c) Transfer of title shall not operate to convey to Customer any right to make, or have made, any Product supplied by ProSoft.
- d) Customer is granted no right or license to use any software or other intellectual property in any manner or for any purpose not expressly permitted by any license agreement accompanying such software or other intellectual property.
- e) Customer agrees that it shall not, and shall not authorize others to, copy software provided by ProSoft (except as expressly permitted in any license agreement accompanying such software); transfer software to a third party separately from the Product; modify, alter, translate, decode, decompile, disassemble, reverse-engineer or otherwise attempt to derive the source code of the software or create derivative works based on the software; export the software or underlying technology in contravention of applicable US and international export laws and regulations; or use the software other than as authorized in connection with use of Product.
- f) **Additional Restrictions Relating To Software And Other Intellectual Property**

In addition to compliance with the Terms of this Warranty, Customers purchasing software or other intellectual property shall comply with any license agreement accompanying such software or other intellectual property. Failure to do so may void this Warranty with respect to such software and/or other intellectual property.

6.3.5 Disclaimer of all Other Warranties

The Warranty set forth in What Is Covered By This Warranty (page 72) are in lieu of all other warranties, express or implied, including but not limited to the implied warranties of merchantability and fitness for a particular purpose.

6.3.6 Limitation of Remedies **

In no event will ProSoft or its Dealer be liable for any special, incidental or consequential damages based on breach of warranty, breach of contract, negligence, strict tort or any other legal theory. Damages that ProSoft or its Dealer will not be responsible for included, but are not limited to: Loss of profits; loss of savings or revenue; loss of use of the product or any associated equipment; loss of data; cost of capital; cost of any substitute equipment, facilities, or services; downtime; the claims of third parties including, customers of the Purchaser; and, injury to property.

** Some areas do not allow time limitations on an implied warranty, or allow the exclusion or limitation of incidental or consequential damages. In such areas, the above limitations may not apply. This Warranty gives you specific legal rights, and you may also have other rights which vary from place to place.

6.3.7 Time Limit for Bringing Suit

Any action for breach of warranty must be commenced within 39 months following shipment of the Product.

6.3.8 No Other Warranties

Unless modified in writing and signed by both parties, this Warranty is understood to be the complete and exclusive agreement between the parties, suspending all oral or written prior agreements and all other communications between the parties relating to the subject matter of this Warranty, including statements made by salesperson. No employee of ProSoft or any other party is authorized to make any warranty in addition to those made in this Warranty. The Customer is warned, therefore, to check this Warranty carefully to see that it correctly reflects those terms that are important to the Customer.

6.3.9 Allocation of Risks

This Warranty allocates the risk of product failure between ProSoft and the Customer. This allocation is recognized by both parties and is reflected in the price of the goods. The Customer acknowledges that it has read this Warranty, understands it, and is bound by its Terms.

6.3.10 Controlling Law and Severability

This Warranty shall be governed by and construed in accordance with the laws of the United States and the domestic laws of the State of California, without reference to its conflicts of law provisions. If for any reason a court of competent jurisdiction finds any provisions of this Warranty, or a portion thereof, to be unenforceable, that provision shall be enforced to the maximum extent permissible and the remainder of this Warranty shall remain in full force and effect. Any cause of action with respect to the Product or Services must be instituted in a court of competent jurisdiction in the State of California.

Index

A

Adding a Module • 23
 Adding a Project • 24
 All Product Returns: • 70
 Allocation of Risks • 75

B

Backplane Data Transfer • 52
 Battery Life Advisory • 2

C

Cable Connections • 59
 Clearing a Fault Condition • 47
 Client Command List • 58
 Client Driver • 57
 Cold Boot • 56
 Command Control • 55
 Command Control Blocks • 53
 Command Entry Formats • 28
 Command List Entry Errors • 59
 Command List Overview • 27
 Commands Supported by the Module • 28
 Comment Entries • 25
 Configuration File • 26
 Configuring RSLinx • 16
 Connect your PC to the Module • 17
 Connect your PC to the Processor • 14
 Controlling Law and Severability • 75

D

Data Flow between MVI46-BDW Module and SLC
 Processor • 57
 Database View Menu • 41
 DB9 to RJ45 Adaptor (Cable 14) • 63
 Diagnostics and Troubleshooting • 7, 35
 Disabling the RSLinx Driver for the Com Port on the
 PC • 60
 Disclaimer of all Other Warranties • 74
 Disclaimer Regarding High Risk Activities • 73
 Displaying the Current Page of Registers Again • 42
 Download the Project to the Module • 31
 Download the Sample Program to the Processor • 15

E

Error/Status Data Table • 63
 Ethernet Connection • 59
 Ethernet LED Indicators • 47
 Ethernet Port Configuration - wattcp.cfg • 60
 Event Command • 53
 Exiting the Program • 41

F

Features and Benefits • 49
 Functional Overview • 7, 51
 Functional Specifications • 50

G

General Concepts • 51
 General Specifications • 49
 Guide to the MVI46-BDW User Manual • 7

H

Hardware Specifications • 49
 How to Contact Us
 Technical Support • 69, 70

I

Initialize Output Data • 53
 Install ProSoft Configuration Builder Software • 10
 Install the Module in the Rack • 12
 Installing and Configuring the Module • 19
 Intellectual Property Indemnity • 73

K

Keystrokes • 38

L

Ladder Logic • 33
 LED Status Indicators • 7, 46
 Limitation of Remedies ** • 74
 LIMITED WARRANTY • 71, 72

M

Main Logic Loop • 51
 Main Menu • 38
 Master Command Error List Menu • 43
 Master Command List Menu • 44
 Module Configuration • 19
 Module Data • 21
 Module Entries • 25
 Module Power Up • 51
 Moving Back Through 5 Pages of Registers • 42
 MVI46-BDW Configuration Data • 66
 MVI46-BDW Status Data Definition • 63

N

Navigation • 37
 Network Menu • 40, 45
 No Other Warranties • 75

O

Opening the Command Error List Menu • 39
 Opening the Command List Menu • 39
 Opening the Database Menu • 39
 Opening the Network Menu • 40

P

Package Contents • 10

Pinouts • 59, 63
Please Read This Notice • 2
Printing a Configuration File • 26
Procedures for Return of Units Out of Warranty: • 71
Procedures for Return of Units Under Warranty: • 71
Product Specifications • 7, 49
ProSoft Configuration Builder • 21
ProSoft® Product Documentation • 3
Purchasing Warranty Extension: • 71

R

Reading Status Data from the Module • 35
Redisplaying the Current Page • 43, 44
Reference • 7, 49
Required Hardware • 35
Resetting diagnostic data • 40
Return Material Authorization (RMA) Policies and Conditions • 70
Returning to the Main Menu • 43, 44, 45
RS-232 Configuration/Debug Port • 60

S

Set Module Parameters • 19, 24
Set Up the Project • 22
Setting Jumpers • 12
Skipping 500 Registers of Data • 42
Standard BARDAC DW E-Series Errors • 58
Standard BARDAC DW PL/X Series Errors • 58
Start Here • 7, 9
Support, Service & Warranty • 7, 69
System Requirements • 9

T

The Configuration/Debug Menu • 36
Time Limit for Bringing Suit • 75
Transferring the Configuration File from MVI46 module to PC • 39
Transferring the Configuration File from PC to MVI46 module • 39
Transferring WATTCP.CFG to the module • 45
Transferring WATTCP.CFG to the PC • 45
Troubleshooting • 48

U

UDP Error Codes • 59
Using the Diagnostic Window in ProSoft Configuration Builder • 36

V

Viewing Block Transfer Statistics • 38
Viewing Client Status • 40
Viewing Data in ASCII (Text) Format • 42
Viewing Data in Decimal Format • 42
Viewing Data in Floating Point Format • 42
Viewing Data in Hexadecimal Format • 42
Viewing Module Configuration • 39
Viewing Register Pages • 41
Viewing the Next 100 Registers of Data • 42
Viewing the Next 20 Commands • 43

Viewing the Next 50 Commands • 44
Viewing the Next Page of Commands • 43, 44
Viewing the Previous 100 Registers of Data • 42
Viewing the Previous 20 Commands • 43
Viewing the Previous 50 Commands • 44
Viewing the Previous Page of Commands • 43, 44
Viewing the WATTCP.CFG file on the module • 45
Viewing Version Information • 40

W

Warm Boot • 56
Warm Booting the Module • 40
What Is Covered By This Warranty • 72, 74
What Is Not Covered By This Warranty • 72

Y

Your Feedback Please • 2