

inRAx



MVI56-KOS150

ControlLogix Platform

KOS 150 Communication Protocol Module

User Manual

April 30, 2008

ProSoft
TECHNOLOGY

Please Read This Notice

Successful application of this module requires a reasonable working knowledge of the Rockwell Automation ControlLogix hardware, the MVI56-KOS150 Module and the application in which the combination is to be used. For this reason, it is important that those responsible for implementation satisfy themselves that the combination will meet the needs of the application without exposing personnel or equipment to unsafe or inappropriate working conditions.

This manual is provided to assist the user. Every attempt has been made to ensure that the information provided is accurate and a true reflection of the product's installation requirements. In order to ensure a complete understanding of the operation of the product, the user should read all applicable Rockwell Automation documentation on the operation of the Rockwell Automation hardware.

Under no conditions will ProSoft Technology be responsible or liable for indirect or consequential damages resulting from the use or application of the product.

Reproduction of the contents of this manual, in whole or in part, without written permission from ProSoft Technology is prohibited.

Information in this manual is subject to change without notice and does not represent a commitment on the part of ProSoft Technology Improvements and/or changes in this manual or the product may be made at any time. These changes will be made periodically to correct technical inaccuracies or typographical errors.

Warnings

UL Warnings

- A** Warning - Explosion Hazard - Substitution of components may impair suitability for Class I, Division 2.
- B** Warning - Explosion Hazard - When in Hazardous Locations, turn off power before replacing or rewiring modules.
Warning - Explosion Hazard - Do not disconnect equipment unless power has been switched off or the area is known to be nonhazardous.
- C** Suitable for use in Class I, division 2 Groups A, B, C and D Hazardous Locations or Non-Hazardous Locations.

ATEX Warnings and Conditions of Safe Usage:

Power, Input, and Output (I/O) wiring must be in accordance with the authority having jurisdiction

- A** Warning - Explosion Hazard - When in hazardous locations, turn off power before replacing or wiring modules.
- B** Warning - Explosion Hazard - Do not disconnect equipment unless power has been switched off or the area is known to be non-hazardous.
- C** These products are intended to be mounted in an IP54 enclosure. The devices shall provide external means to prevent the rated voltage being exceeded by transient disturbances of more than 40%. This device must be used only with ATEX certified backplanes.
- D** DO NOT OPEN WHEN ENERGIZED.

Electrical Ratings

- Backplane Current Load: 800 mA @ 5 V DC; 3mA @ 24V DC
- Operating Temperature: 0 to 60°C (32 to 140°F)
- Storage Temperature: -40 to 85°C (-40 to 185°F)
- Shock: 30g Operational; 50g non-operational; Vibration: 5 g from 10 to 150 Hz
- Relative Humidity 5% to 95% (non-condensing)
- All phase conductor sizes must be at least 1.3 mm(squared) and all earth ground conductors must be at least 4mm(squared).

Markings:



II 3 G 0C <=Ta<= 60C EEx nA IIC T4 DEMKO 07ATEX0710717X

Battery Life Advisory

All modules in the MVI series use a rechargeable Lithium Vanadium Pentoxide battery to backup the 512K SRAM memory, real-time clock, and CMOS. The battery should last for the life of the module.

The module must be powered for approximately twenty hours before it becomes fully charged. After it is fully charged, the battery provides backup power for the CMOS setup and configuration data, the real-time clock, and the 512K SRAM memory for approximately 21 days.

Before you remove a module from its power source, ensure that the battery within the module is fully charged. A fully charged battery will hold the BIOS settings (after being removed from its power source) for a limited number of days. When the battery is fully discharged, the module will revert to the default BIOS settings.

Note: The battery is not user replaceable.

ProSoft® Product Documentation

In an effort to conserve paper, ProSoft Technology no longer includes printed manuals with our product shipments. User Manuals, Datasheets, Sample Ladder Files, and Configuration Files are provided on the enclosed CD and are available at no charge from our web site: <http://www.prosoft-technology.com>

Printed documentation is available for purchase. Contact ProSoft Technology for pricing and availability.

Asia Pacific: +603.7724.2080

Europe, Middle East, South Africa: +33.5.34.36.87.20

Latin America: +1.281.298.9109

North America: +1.661.716.5100

Your Feedback Please

We always want you to feel that you made the right decision to use our products. If you have suggestions, comments, compliments or complaints about the product, documentation or support, please write or call us.

ProSoft Technology

1675 Chester Avenue, Fourth Floor

Bakersfield, CA 93301

+1 (661) 716-5100

+1 (661) 716-5101 (Fax)

<http://www.prosoft-technology.com>

Copyright © ProSoft Technology, Inc. 2000 - 2008. All Rights Reserved.

MVI56-KOS150 User Manual

April 30, 2008

PSFT.KOS.MVI56.UM.08.04.30

ProSoft Technology®, ProLinX®, inRAx®, ProTalk® and RadioLinX® are Registered Trademarks of ProSoft Technology, Inc.

Contents

PLEASE READ THIS NOTICE.....	2
Warnings.....	2
Battery Life Advisory.....	3
ProSoft® Product Documentation.....	3
Your Feedback Please.....	4
GUIDE TO THE MVI56-KOS150 USER MANUAL.....	7
1 START HERE.....	9
1.1 System Requirements.....	9
1.2 Package Contents.....	10
1.3 Install ProSoft Configuration Builder Software.....	10
1.4 Setting Jumpers.....	12
1.5 Install the Module in the Rack.....	12
1.6 Connect your PC to the Processor.....	14
1.7 Open the Sample Ladder Logic.....	15
1.7.1 To Determine the Firmware Version of your Processor.....	15
1.7.2 Select the Slot Number for the Module.....	16
1.7.3 Configuring RSLinx.....	17
1.8 Download the Sample Program to the Processor.....	18
1.9 Connect your PC to the Module.....	19
2 MODULE CONFIGURATION.....	21
2.1 Installing and Configuring the Module.....	21
2.2 Module Data.....	26
2.2.1 Main Data Object (KOS150Module).....	26
2.2.2 Helper Objects.....	29
2.3 ProSoft Configuration Builder.....	29
2.3.1 Set Up the Project.....	30
2.3.2 Set Module Parameters.....	32
2.4 MVI56-KOS150 Configuration Data.....	34
2.5 Download the Project to the Module.....	35
3 LADDER LOGIC.....	37
4 DIAGNOSTICS AND TROUBLESHOOTING.....	39
4.1 Reading Status Data from the Module.....	39
4.1.1 Required Hardware.....	39
4.1.2 The Configuration/Debug Menu.....	40
4.1.3 Main Menu.....	42
4.2 LED Status Indicators.....	45
4.2.1 Clearing a Fault Condition.....	45
4.2.2 Troubleshooting.....	46
5 REFERENCE.....	47
5.1 Product Specifications.....	47
5.1.1 Features and Benefits.....	47
5.1.2 General Specifications.....	47
5.1.3 Hardware Specifications.....	48
5.1.4 Functional Specifications.....	48
5.2 Functional Overview.....	49
5.2.1 General Concepts.....	49
5.3 Cable Connections.....	59
5.3.1 RS-232.....	59
5.3.2 RS-232 Configuration/Debug Port.....	61

5.3.3	DB9 to RJ45 Adaptor (Cable 14).....	63
6	SUPPORT, SERVICE & WARRANTY	65
6.1	How to Contact Us: Sales and Support.....	66
6.2	Return Material Authorization (RMA) Policies and Conditions.....	66
6.2.1	All Product Returns	67
6.3	Procedures for Return of Units Under Warranty	67
6.4	Procedures for Return of Units Out of Warranty	68
6.4.1	Un-repairable Units	68
6.4.2	Purchasing Warranty Extension	69
6.5	LIMITED WARRANTY	69
6.5.1	What Is Covered By This Warranty	69
6.5.2	What Is Not Covered By This Warranty.....	70
6.5.3	DISCLAIMER REGARDING HIGH RISK ACTIVITIES	71
6.5.4	DISCLAIMER OF ALL OTHER WARRANTIES	71
6.5.5	LIMITATION OF REMEDIES**	71
6.5.6	Time Limit for Bringing Suit	71
6.5.7	No Other Warranties	72
6.5.8	Intellectual Property.....	72
6.5.9	Additional Restrictions Relating To Software And Other Intellectual Property.....	72
6.5.10	Allocation of risks	72
6.5.11	Controlling Law and Severability	73
INDEX.....	75

Guide to the MVI56-KOS150 User Manual

Function		Section to Read	Details
Introduction (Must Do)	→	Start Here (page 9)	This Section introduces the customer to the module. Included are: package contents, system requirements, hardware installation, and basic configuration.
Verify Communication, Diagnostic and Troubleshooting	→	Verifying Communication (page 45) Diagnostics and Troubleshooting (page 39)	This section describes how to verify communications with the network. Diagnostic and Troubleshooting procedures.
Reference Product Specifications Functional Overview Glossary	→	Reference (page 47) Functional Overview (page 49) Product Specifications (page 47)	These sections contain general references associated with this product, Specifications, and the Functional Overview.
Support, Service, and Warranty Index	→	Support, Service and Warranty (page 65)	This section contains Support, Service and Warranty information. Index of chapters.

1 Start Here

In This Chapter

❖ System Requirements	9
❖ Package Contents	10
❖ Install ProSoft Configuration Builder Software.....	10
❖ Setting Jumpers	12
❖ Install the Module in the Rack	12
❖ Connect your PC to the Processor	14
❖ Open the Sample Ladder Logic.....	15
❖ Download the Sample Program to the Processor.....	18
❖ Connect your PC to the Module	19

Installing the MVI56-KOS150 module requires a reasonable working knowledge of the Rockwell Automation hardware, the MVI56-KOS150 Module and the application in which they will be used.



Caution: It is important that those responsible for implementation can complete the application without exposing personnel, or equipment, to unsafe or inappropriate working conditions. Safety, quality and experience are key factors in a successful installation.

1.1 System Requirements

The MVI56-KOS150 module requires the following minimum hardware and software components:

- Rockwell Automation ControlLogix™ processor, with compatible power supply and one free slot in the rack, for the MVI56-KOS150 module. The module requires 800mA of available power.
- Rockwell Automation RSLogix 5000 programming software version 2.51 or higher.
- Rockwell Automation RSLinx communication software
- Pentium® II 450 MHz minimum. Pentium III 733 MHz (or better) recommended
- Supported operating systems:
 - Microsoft Windows XP Professional with Service Pack 1 or 2
 - Microsoft Windows 2000 Professional with Service Pack 1, 2, or 3
 - Microsoft Windows Server 2003
- 128 Mbytes of RAM minimum, 256 Mbytes of RAM recommended

- 100 Mbytes of free hard disk space (or more based on application requirements)
- 256-color VGA graphics adapter, 800 x 600 minimum resolution (True Color 1024 × 768 recommended)
- CD-ROM drive
- HyperTerminal or other terminal emulator program.

Note: You can install the module in a local or remote rack. For remote rack installation, the module requires EtherNet/IP or ControlNet communication with the processor.

1.2 Package Contents

The following components are included with your MVI56-KOS150 module, and are all required for installation and configuration.

Important: Before beginning the installation, please verify that all of the following items are present.

Qty.	Part Name	Part Number	Part Description
1	MVI56-KOS150 Module	MVI56-KOS150	KOS 150 Communication Protocol Module
1	Cable	Cable #15, RS232 Null Modem	For RS232 Connection to the CFG Port
3	Cable	Cable #14, RJ45 to DB9 Male Adapter cable	For DB9 Connection to Module's Port
2	Adapter	1454-9F	Two Adapters, DB9 Female to Screw Terminal. For RS422 or RS485 Connections to Port 1 and 2 of the Module
1	ProSoft Solutions CD		Contains sample programs, utilities and documentation for the MVI56-KOS150 module.

If any of these components are missing, please contact ProSoft Technology Support for replacement parts.

1.3 Install ProSoft Configuration Builder Software

You must install the ProSoft Configuration Builder (PCB) software in order to configure the MVI56-KOS150 module. You can always get the newest version of ProSoft Configuration Builder from the ProSoft Technology web site.

To install ProSoft Configuration Builder from the ProSoft Web Site

- 1 Open your web browser and navigate to <http://www.prosoft-technology.com/pcb>
- 2 Click the **Download Here** link to download the latest version of ProSoft Configuration Builder.

- 3 Choose "Save" or "Save File" when prompted. The following illustrations show the file download prompt for two of the most common web browsers.

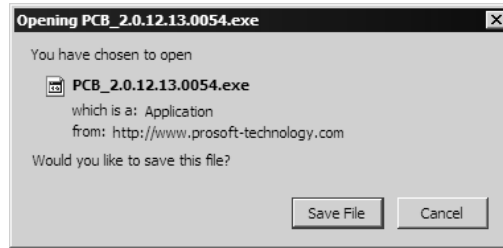

- 4 Make a note of the location where you saved the file, for example "Desktop", or "My Documents", so you can start the installation program.
- 5 When the download is complete, locate and open the file, and then follow the instructions on your screen to install the program.

If you do not have access to the Internet, you can install ProSoft Configuration Builder from the ProSoft Solutions CD-ROM, included in the package with your MVI56-KOS150 module.

To install ProSoft Configuration Builder from the CD-ROM

- 1 Insert the ProSoft Solutions CD-ROM into the CD drive of your PC. Wait for the startup screen to appear.
- 2 On the startup screen, click *Product Documentation*. This action opens an explorer window.
- 3 Click to open the *Utilities* folder. This folder contains all of the applications and files you will need to set up and configure your module.
- 4 Double-click the *ProSoft Configuration Builder Setup* program and follow the instructions on your screen to install the software on your PC.

Note: Many of the configuration and maintenance procedures use files and other utilities on the CD-ROM. You may wish to copy the files from the Utilities folder on the CD-ROM to a convenient location on your hard drive.

1.4 Setting Jumpers

If you use an interface other than RS-232 (default), you must change the jumper configuration to match the interface. There are three jumpers located at the bottom of the module.

The following illustration shows the MVI56-KOS150 jumper configuration:

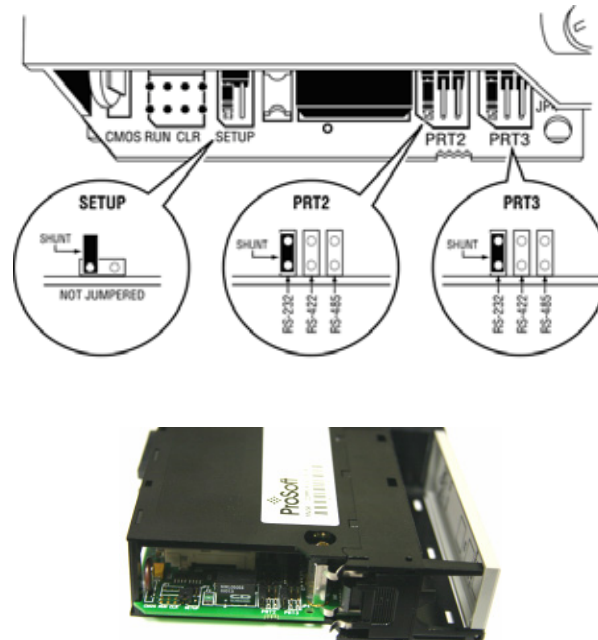

- 1 Set the PRT 2 (for application port 1) and PRT 3 (for application port 2) jumpers for RS232, RS422 or RS485 to match the wiring needed for your application. The default jumper setting for both application ports is RS-232.
- 2 The Setup Jumper acts as "write protection" for the module's flash memory. In "write protected" mode, the Setup pins are not connected, and the module's firmware cannot be overwritten. Do not jumper the Setup pins together unless you are directed to do so by ProSoft Technical Support.

1.5 Install the Module in the Rack

If you have not already installed and configured your ControlLogix processor and power supply, please do so before installing the MVI56-KOS150 module. Refer to your Rockwell Automation product documentation for installation instructions.

Warning: You must follow all safety instructions when installing this or any other electronic devices. Failure to follow safety procedures could result in damage to hardware or data, or even serious injury or death to personnel. Refer to the documentation for each device you plan to connect to verify that suitable safety procedures are in place before installing or servicing the device.

After you have checked the placement of the jumpers, insert MVI56-KOS150 into the ControlLogix chassis. Use the same technique recommended by Rockwell Automation to remove and install ControlLogix modules.

Warning: When you insert or remove the module while backplane power is on, an electrical arc can occur. This could cause an explosion in hazardous location installations. Verify that power is removed or the area is non-hazardous before proceeding. Repeated electrical arcing causes excessive wear to contacts on both the module and its mating connector. Worn contacts may create electrical resistance that can affect module operation.

- 1 Turn power OFF.
- 2 Align the module with the top and bottom guides, and slide it into the rack until the module is firmly against the backplane connector.

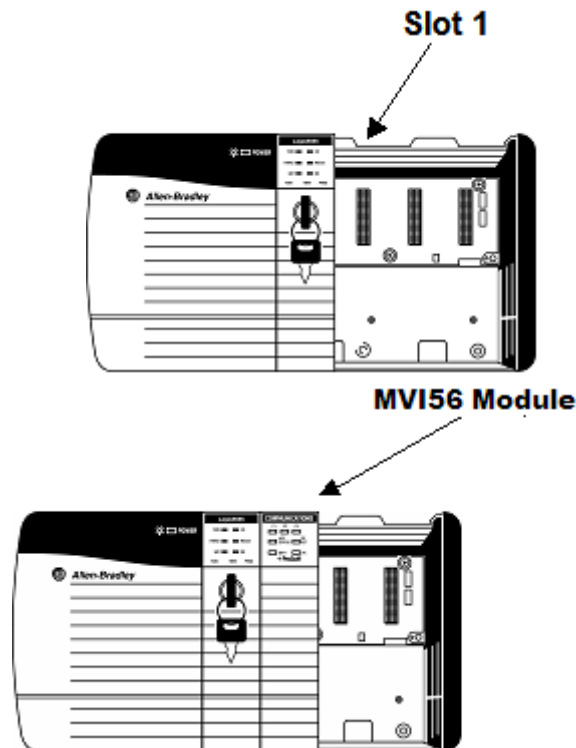

- 3 With a firm but steady push, snap the module into place.
- 4 Check that the holding clips on the top and bottom of the module are securely in the locking holes of the rack.
- 5 Make a note of the slot location. You will need to identify the slot in which the module is installed in order for the sample program to work correctly. Slot numbers are identified on the green circuit board (backplane) of the ControlLogix rack.
- 6 Turn power ON.

Note: If you insert the module improperly, the system may stop working, or may behave unpredictably.

Note: If you are installing MVI56-KOS150 with other modules connected to the PCI bus, the peripheral modules will not have holding clips. Make sure all of the modules are aligned with their respective slots before you snap them into place.

1.6 Connect your PC to the Processor

- 1 Connect the right-angle connector end of the cable to your controller at the communications port.

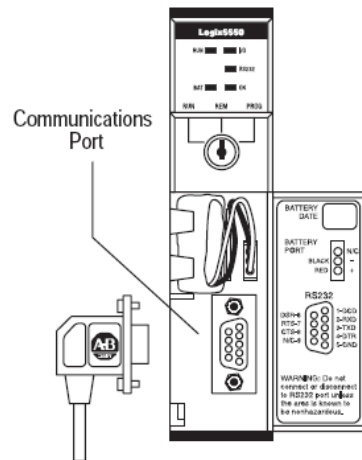

- 2 Connect the straight connector end of the cable to the serial port on your computer.

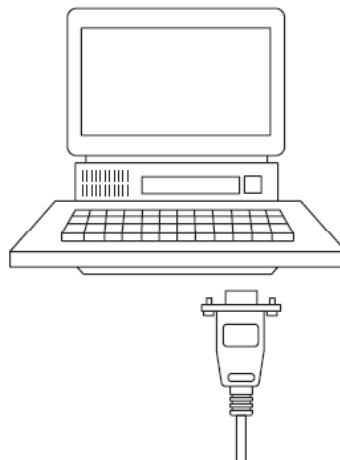

1.7 Open the Sample Ladder Logic

The sample program for your MVI56-KOS150 module includes custom tags, data types and ladder logic for data I/O and status monitoring. For most applications, you can run the sample ladder program without modification, or, for advanced applications, you can incorporate the sample program into your existing application.

The inRAX Solutions CD provides one or more versions of the sample ladder logic. The version number appended to the file name corresponds with the firmware version number of your ControlLogix processor. The firmware version and sample program version must match.

1.7.1 To Determine the Firmware Version of your Processor

Important: The RSLinx service must be installed and running on your computer in order for RSLogix to communicate with the processor. Refer to your RSLinx and RSLogix documentation for help configuring and troubleshooting these applications.

- 1 Connect an RS-232 serial cable from the COM (serial) port on your PC to the communication port on the front of the processor.
- 2 Start RSLogix 5000 and close any existing project that may be loaded.
- 3 Open the Communications menu and choose **Go Online**. RSLogix will establish communication with the processor. This may take a few moments.
- 4 When RSLogix has established communication with the processor, the Connected To Go Online dialog box will open.

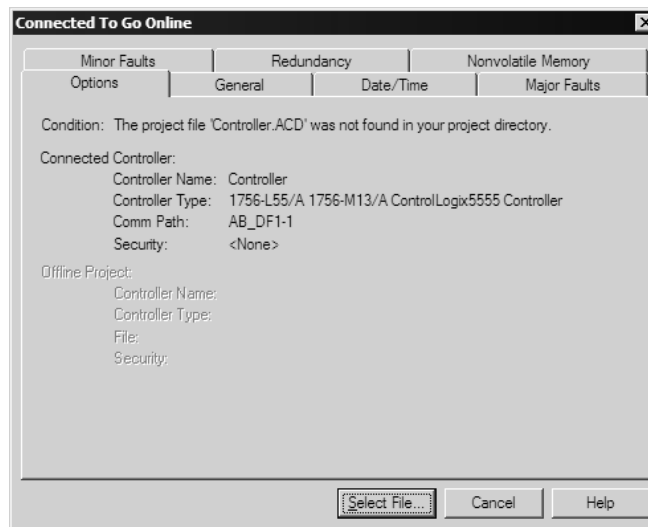

- On the Connected To Go Online dialog box, click the General tab. This tab shows information about the processor, including the Revision (firmware) version. In the following illustration, the firmware version is 11.32

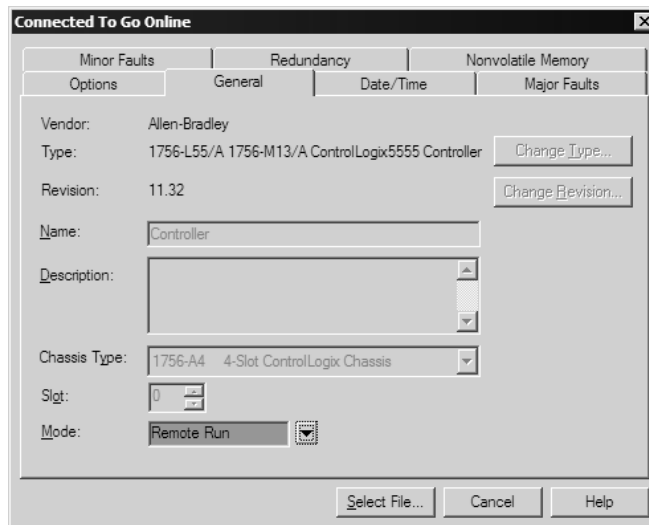

1.7.2 Select the Slot Number for the Module

The sample application is for a module installed in Slot 1 in a ControlLogix rack. The ladder logic uses the slot number to identify the module. If you are installing the module in a different slot, you must update the ladder logic so that program tags and variables are correct, and do not conflict with other modules in the rack.

To change the slot number

- In the Controller Organization list, select the module [1] 1756-MODULE MVI56, and then click the right mouse button to open a shortcut menu.
- On the shortcut menu, choose **Properties**. This action opens the Module Properties dialog box.

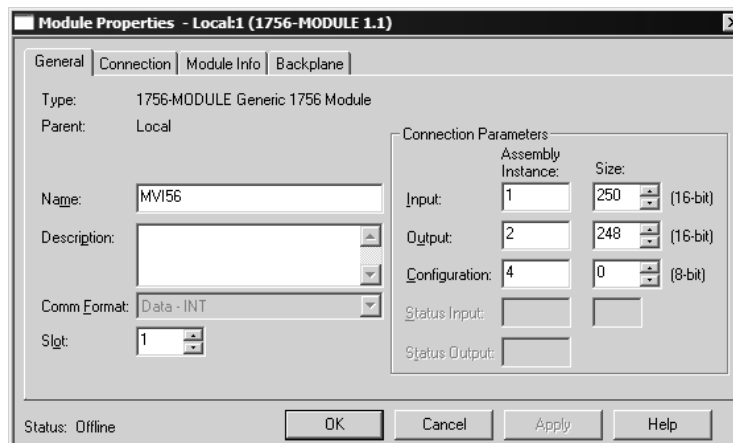

- 3 In the **Slot:** field, use the spinners on the right side of the field to select the slot number where the module will reside in the rack, and then click OK.

RSLogix will automatically apply the slot number change to all tags, variables and ladder logic rungs that use the MVI56-KOS150 slot number for computation.

1.7.3 Configuring RSLinx

If RSLogix is unable to establish communication with the processor, follow these steps:

- 1 Open RSLinx.
- 2 Open the Communications menu, and choose Configure Drivers.

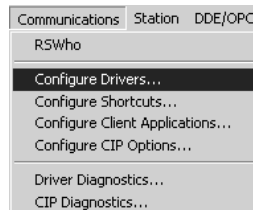

This action opens the Configure Drivers dialog box.

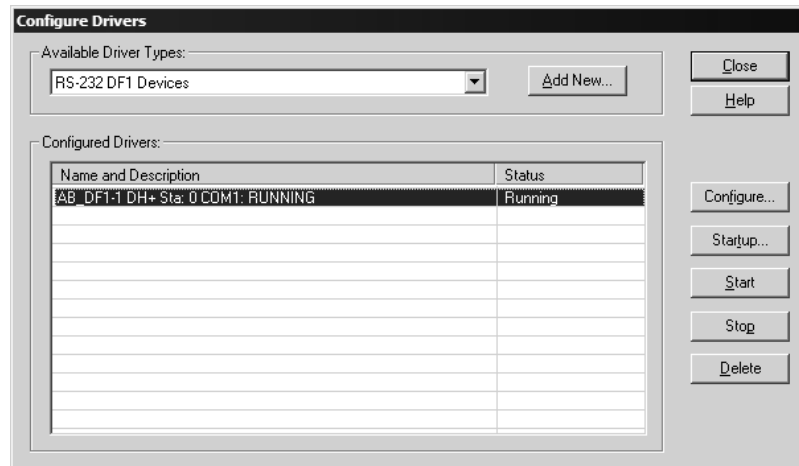

Note: If the list of configured drivers is blank, you must first choose and configure a driver from the Available Driver Types list. The recommended driver type to choose for serial communication with the processor is "RS-232 DF1 Devices".

- 3 Click to select the driver, and then click Configure. This action opens the Configure Allen-Bradley DF1 Communications Device dialog box.



- 4 Click the Auto-Configure button. RSLinx will attempt to configure your serial port to work with the selected driver.
- 5 When you see the message "Auto Configuration Successful", click the OK button to dismiss the dialog box.

Note: If the auto-configuration procedure fails, verify that the cables are connected correctly between the processor and the serial port on your computer, and then try again. If you are still unable to auto-configure the port, refer to your RSLinx documentation for further troubleshooting steps.

1.8 Download the Sample Program to the Processor

Note: The key switch on the front of the ControlLogix module must be in the REM position.

To download the sample program from RSLogix 5000 to the ControlLogix processor

- 1 If you are not already online to the processor, open the Communications menu, and then choose Download. RSLogix will establish communication with the processor.

- 2 When communication is established, RSLogix will open a confirmation dialog box. Click the Download button to transfer the sample program to the processor.

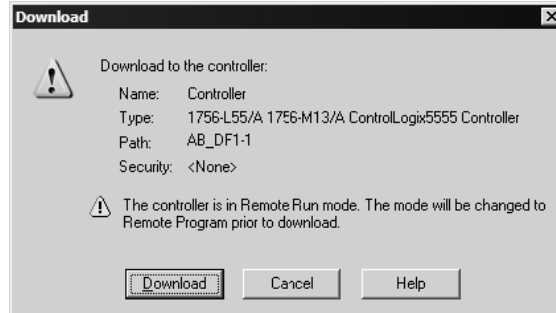

- 3 RSLogix will compile the program and transfer it to the processor. This process may take a few minutes.
- 4 When the download is complete, RSLogix will open another confirmation dialog box. Click OK to switch the processor from Program mode to Run mode.

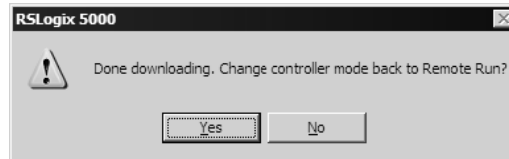

Note: If you receive an error message during these steps, refer to your RSLogix documentation to interpret and correct the error.

1.9 Connect your PC to the Module

With the module securely mounted, connect your PC to the **Configuration/Debug** port using an RJ45-DB-9 Serial Adapter Cable and a Null Modem Cable.

- 1 Attach both cables as shown.
- 2 Insert the RJ45 cable connector into the Configuration/Debug port of the module.

- 3 Attach the other end to the serial port on your PC or laptop.

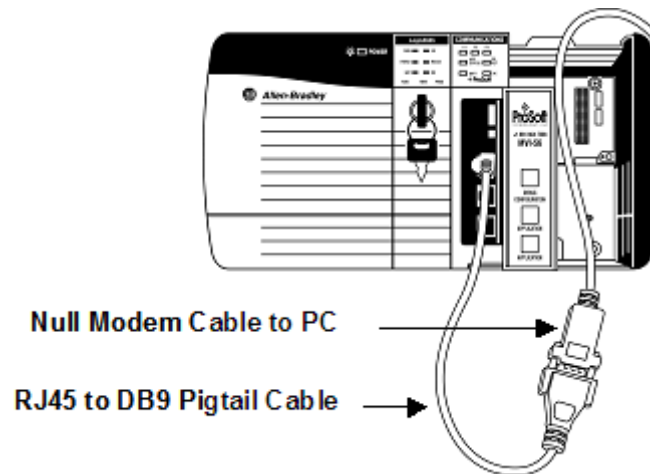

2 Module Configuration

In This Chapter

❖ Installing and Configuring the Module	21
❖ Module Data	26
❖ ProSoft Configuration Builder	29
❖ MVI56-KOS150 Configuration Data	34
❖ Download the Project to the Module.....	35

This section contains the setup procedure, data, and ladder logic for successful application of the MVI56-KOS150 module. Each step in the setup procedure is defined in order to simplify the use of the module.

2.1 Installing and Configuring the Module

This chapter describes how to install and configure the module to work with your application. The configuration process consists of the following steps.

- 1 Use RSLogix to identify the module to the processor and add the module to a project.

Note: The RSLogix software must be in "offline" mode to add the module to a project.

- 2 Modify the module's configuration files to meet the needs of your application, and copy the updated configuration to the module. Example configuration files are provided on the CD-ROM. Refer to the Modifying the Example Configuration File section, later in this chapter, for more information on the configuration files.
- 3 Modify the example ladder logic to meet the needs of your application, and copy the ladder logic to the processor. Example ladder logic files are provided on the CD-ROM.

Note: If you are installing this module in an existing application, you can copy the necessary elements from the example ladder logic into your application.

The rest of this chapter describes these steps in more detail.

The first step in installing and configuring the module is to define the module to the system. Right-click the mouse button on the I/O Configuration option in the Controller Organization window to display a pop-up menu. Select the New Module option from the I/O Configuration menu.

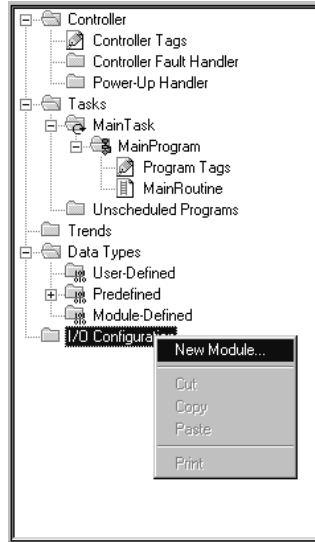

This action opens the following dialog box.

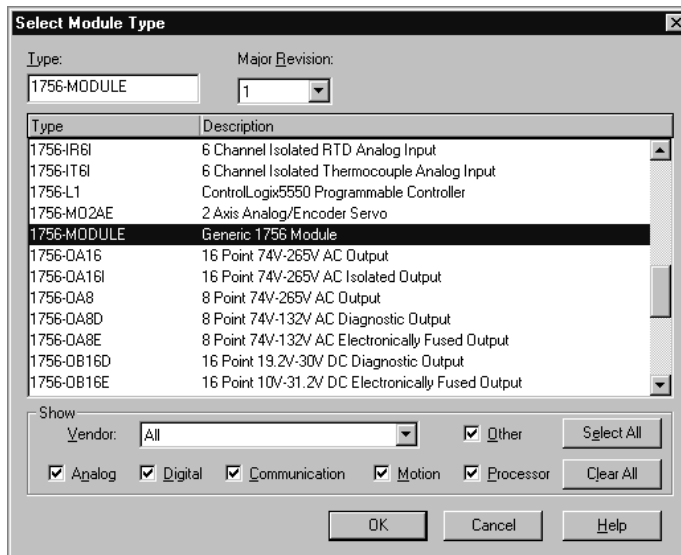

Select the 1756-Module (Generic 1756 Module) from the list and click OK. The following dialog box will be displayed.

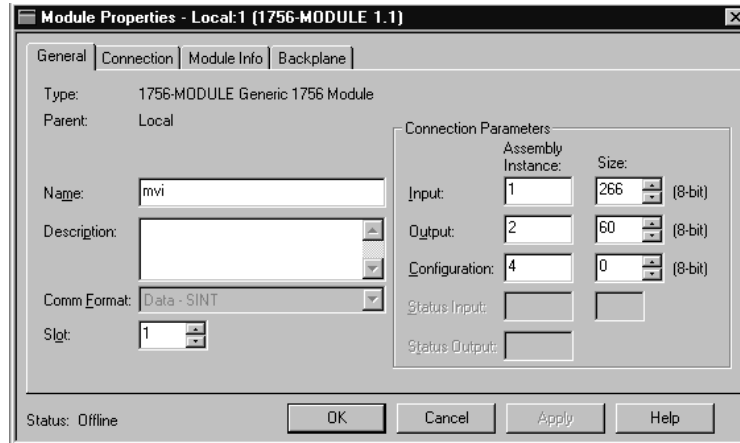

Fill in the dialog box as shown adjusting the Name, Description and Slot options for your application. You must select the **Comm Format** as **Data - SINT** in the dialog box. Failure to set the **Assembly Instance** and **Size** values correctly will result in a module that will not communicate over the backplane of the ControlLogix rack. Click Next to display the next dialog box.

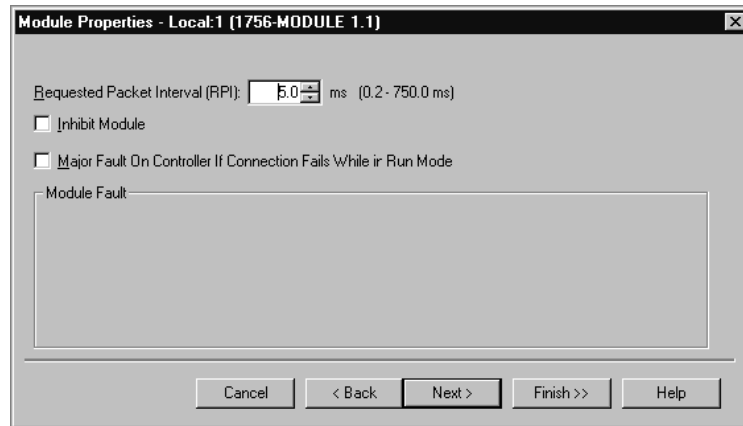

Select the Request Packet Interval value for scanning the I/O on the module. This value represents the minimum frequency that the module will handle scheduled events. This value should not be set to less than 1 millisecond. Values between 1 and 10 milliseconds should work with most applications.

After completing the module setup, the Controller Organization window will display the module's presence. The data required for the module will be defined to the application, and objects will be allocated in the Controller Tags data area. An example of the Controller Organization window is shown below.

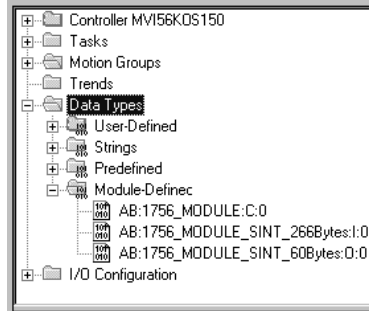

The next step in the module's setup is to define the User Defined Data Types to be used with the module. Copy these data types from the example ladder logic if you are not using the example. They will be defined if you are starting from the example ladder logic. The Controller Organization window should display the User Defined Data Types shown below:

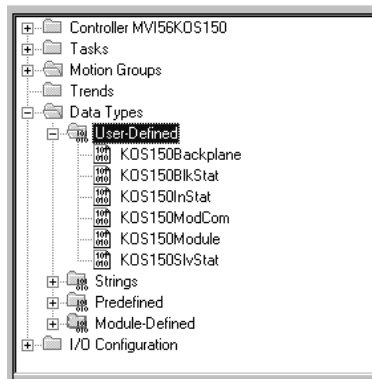

The next step in module setup is to define the data tags to be used to interface with the module and the ladder logic. Open the Controller Tags Edit Tags dialog box and enter the values shown in the following example. The MVI56-KOS150 module is defined in the example as KOS150Slot1 and has a type of KOS150Module. The tag name can be set to any valid tag name desired. When using the example ladder logic, this step has already been performed.

Tag Name	Value	Style	Type	Description
ColdBoot	2#0000_0000	Binary	BOOL	Cold boot MVI56-SMGC module
EndIndex	0	Decimal	SINT	
GetStatus	2#0000_0000	Binary	BOOL	Request the status data block 925
KOS150Slot1	{...}		KOS150Module	
Local:1:C	{...}		AB:1756_MODULE:C:0	
Local:1:I	{...}		AB:1756_MODULE_SINT_266Bytes:I:0	
Local:1:O	{...}		AB:1756_MODULE_SINT_60Bytes:O:0	
MJFAULTS	{...}	Decimal	DINT[12]	
MsgId	0	Decimal	SINT	Message ID for current request
Offline_0	2#0000_0000	Binary	BOOL	
PointIndex	0	Decimal	SINT	
SendClient	{...}	Binary	BDDL[32]	Bits to send different data blocks
SensorDataLen	0	Decimal	SINT	
SensorLen	0	Decimal	SINT	
Sensors	{...}	Decimal	INT[125]	Array to hold data received from s
Slave_Address	0	Decimal	INT	
SlaveId	0	Decimal	SINT	
StartIndex	0	Decimal	SINT	
ValveControl	0	Decimal	SINT	
WallClockTime	{...}	Decimal	DINT[7]	

The last step in the module setup is to add the ladder logic. If the example ladder logic is used, adjust the ladder to fit the application. When the ladder example is not used, copy the ladder logic shown in the Controller Organization window below to the application.

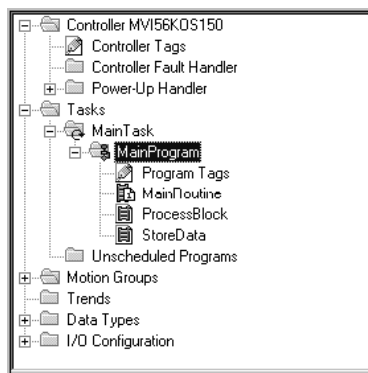

It is now time to edit the KOS150.CFG file to set up the module for the specific application. Refer to the Configuration File section of this document. The module is now set up and ready to be used with your application. Insert the module in the rack and attach the serial communication cables to the debug/configuration port and the application port.

Download the new application to the controller and place the processor in run mode. Download the new KOS150.CFG file to the processor using the debug/configuration port. If all the configuration parameters are set correctly and the module is attached to an Ethernet network, the module's Application LED (APP LED) should remain off and the backplane activity LED (BP ACT) should blink rapidly. Refer to the Trouble Shooting section if you encounter errors. Attach a computer or terminal to Port 1 on the module and look at the status of the module using the Configuration/Debug Menu in the module.

2.2 Module Data

All data related to the MVI56-KOS150 is stored in a user defined data types. An instance of the data types is required before the module can be used. This is accomplished by declaring a variable of the data type in the Controller Tags Edit Tags dialog box. Each of these object types is discussed in the following topics of the document.

2.2.1 Main Data Object (KOS150Module)

The KOS150Module object contains most of the data members and objects required by the MVI56-KOS150 module. An instance of this object should be declared in the controller tags of the processor. The following figure displays this object:

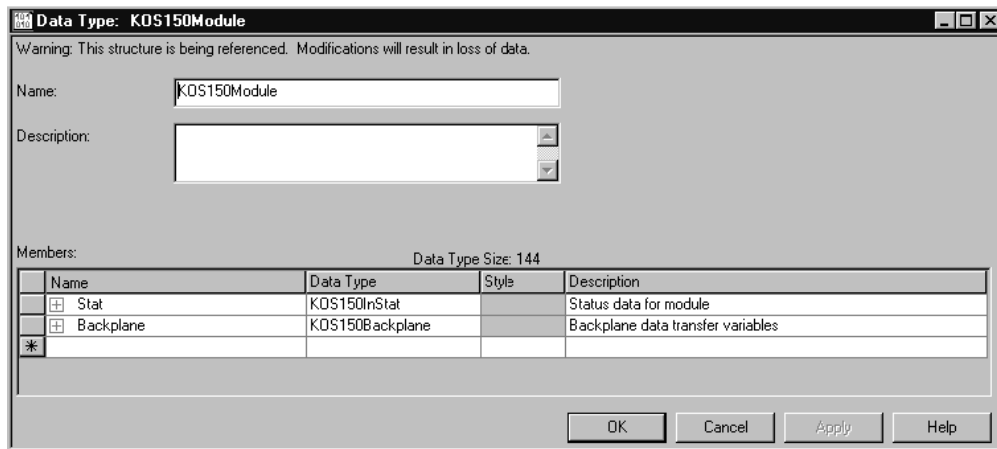

The members of this object are discussed in the following topics.

Status Object (KOS150InStat)

This object views the status of the module. The **KOS150InStat** object shown below is updated after each time the ladder logic makes a request for the data. Use this data to monitor the state of the module at a "real-time rate".

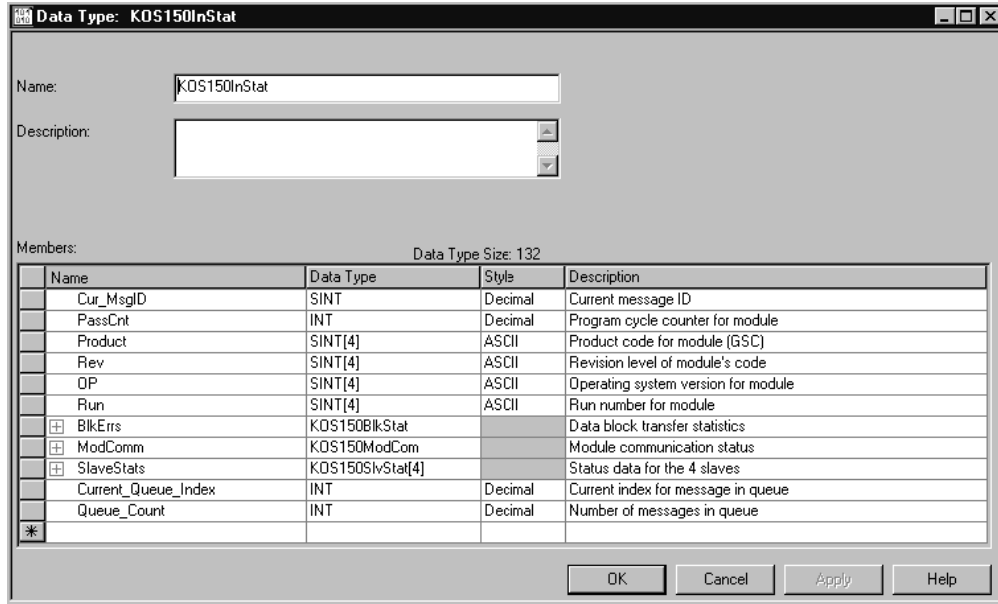

Within the KOS150InStat objects are objects containing the status information for the block transfer process, the port status and the status data for each slave device. The following displays the structure of the KOS150BlkStat object:

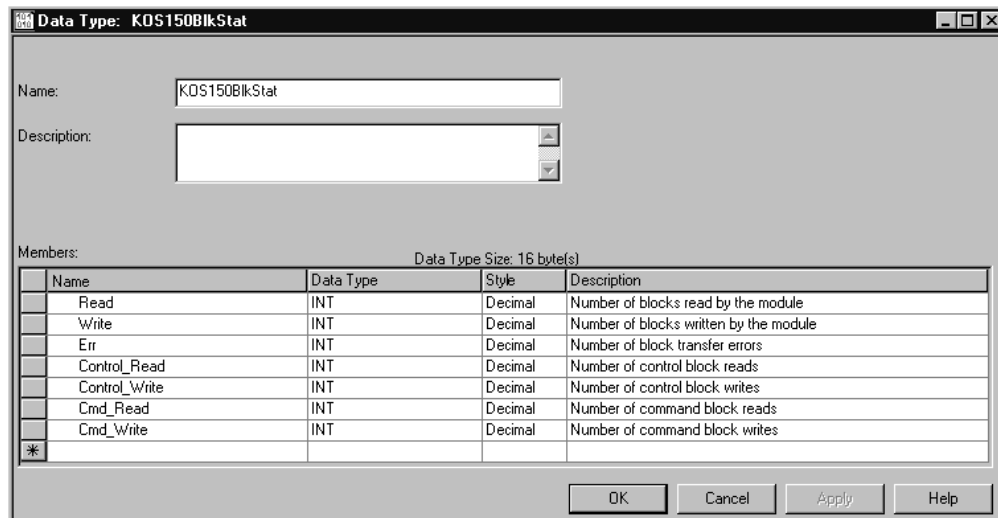

The following displays the structure of the module port status object (KOS150ModCom):

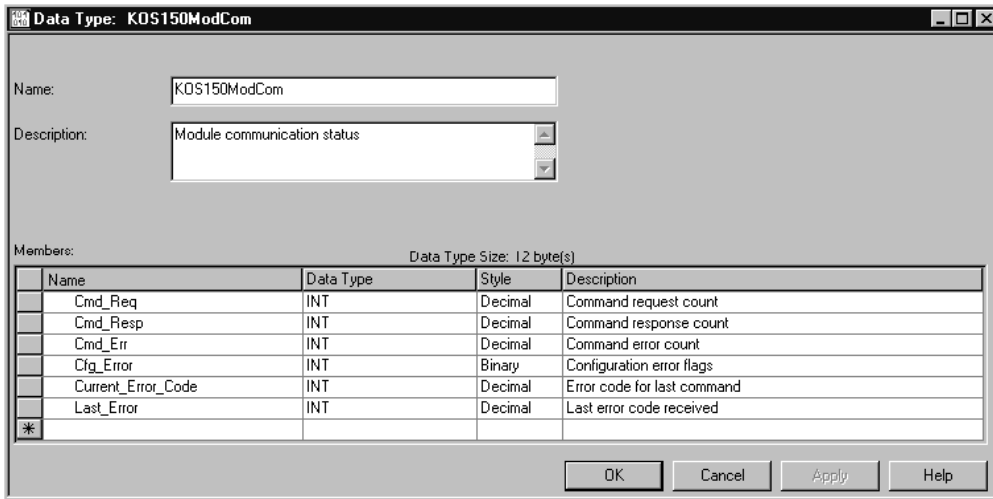

The following displays the structure of the slave status object (KOS150SlvStat) maintained for each of the four slaves:

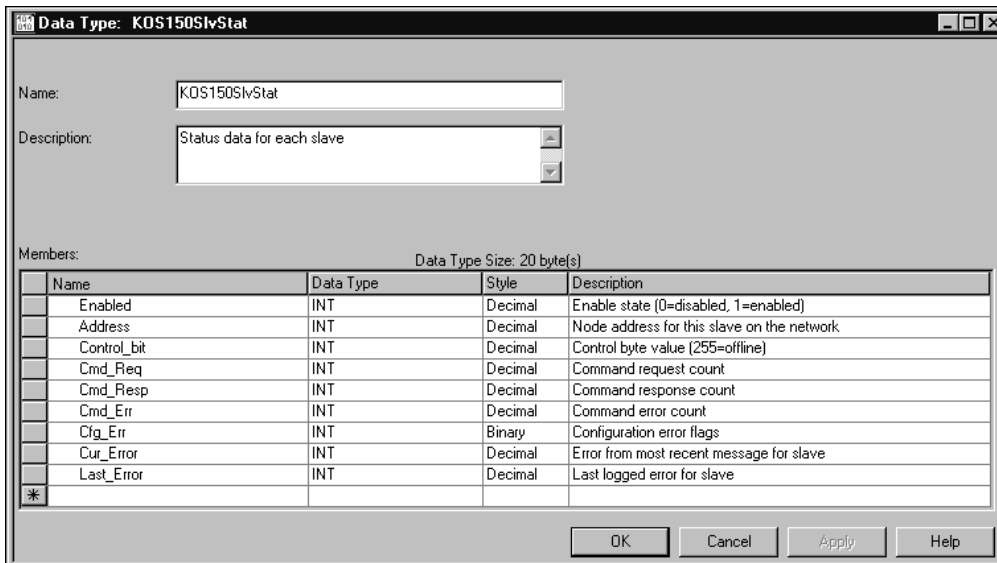

Backplane Variables (KOS150Backplane)

The KOS105Backplane object stores all the variables required for the data transfer operation between the module and the controller. The LastRead data member is used as the handshaking byte to indicate the arrival of new data from the module. The structure of this object is shown in the following illustration:

Data Type: KOS150Backplane				
Name:		KOS150Backplane		
Description:				
Members:		Data Type Size: 12 byte(s)		
Name	Data Type	Style	Description	
LastRead	SINT	Decimal	Sequence number of last block read	
Last_MsgID_Rec	SINT	Decimal	Message ID last received	
Last_MsgError	INT	Decimal	Last error code received (0=no error)	
Q_Count	SINT	Decimal	Number of messages placed in queue	
Q_Msg_IDs	SINT[3]	Decimal	Last number of bytes written	
*				

The other members of the object are utilized in the ladder logic to assist in the data transfer operation.

2.2.2 Helper Objects

Other data types can be defined in the ladder logic to help build request messages or to help parse response messages. Because the MVI56-KOS150 application is written to interface to all KOS 150 protocol slave devices with any configuration, it is the responsibility of the application engineer to construct the other data types required for their application. The sample ladder logic contains examples of such structures. Refer to the KOS 150 protocol specification for a complete understanding of each data block that can be transmitted by the protocol.

2.3 ProSoft Configuration Builder

ProSoft Configuration Builder (PCB) provides a quick and easy way to manage module configuration files customized to meet your application needs. PCB is not only a powerful solution for new configuration files, but also allows you to import information from previously installed (known working) configurations to new projects.

2.3.1 Set Up the Project

To begin, start ProSoft Configuration Builder. If you have used other Windows configuration tools before, you will find the screen layout familiar. ProSoft Configuration Builder's window consists of a tree view on the left, an information pane and a configuration pane on the right side of the window. When you first start ProSoft Configuration Builder, the tree view consists of folders for Default Project and Default Location, with a Default Module in the Default Location folder. The following illustration shows the ProSoft Configuration Builder window with a new project.

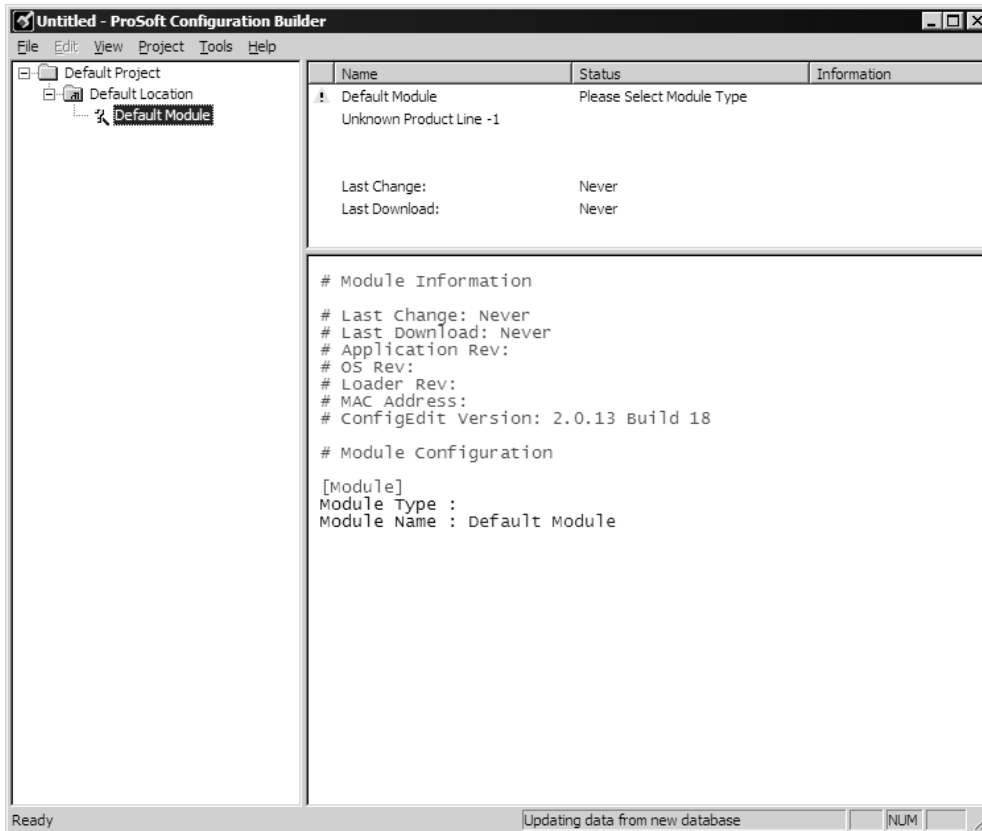

Your first task is to add the MVI56-KOS150 module to the project.

- 1 Use the mouse to select "Default Module" in the tree view, and then click the right mouse button to open a shortcut menu.

- On the shortcut menu, choose "Choose Module Type". This action opens the Choose Module Type dialog box.

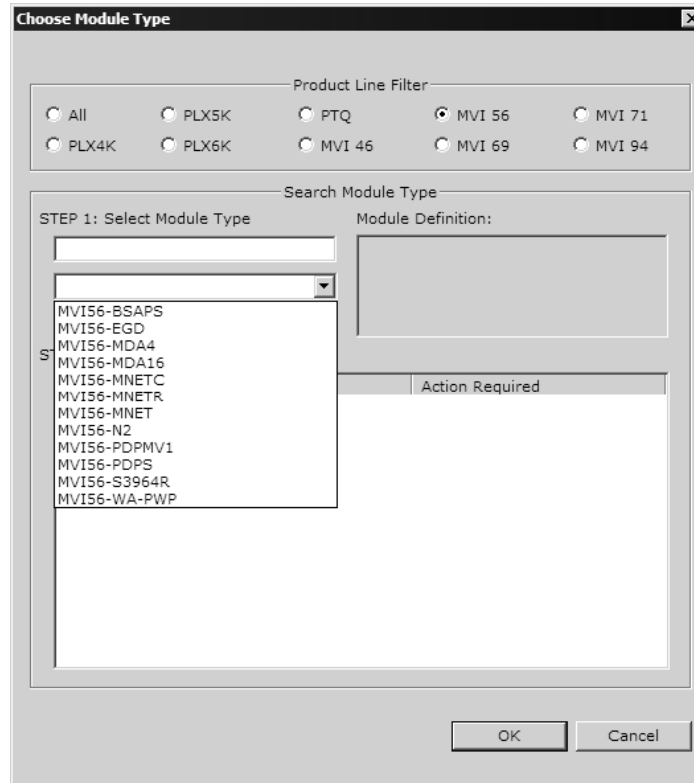

- In the Product Line Filter area of the dialog box, select MVI56. In the Select Module Type dropdown list, select MVI56-KOS150, and then click OK to save your settings and return to the ProSoft Configuration Builder window.

The next task is to set the module parameters.

Adding a Project

To add a project to an existing project file:

- Select the Default Project icon.
- Choose Project from the Project menu, then choose Add Project. A new project folder appears.

Adding a Module

To add a module to your project:

- Double-click the Default Module icon to open the Choose Module Type dialog box.
- On the Choose Module Type dialog box, select the module type.

Or

- Open the Project menu and choose Location.
- On the Location menu, choose Add Module.

To add a module to a different location:

- 1 Right-click the Location folder and choose Add Module. A new module icon appears.

Or

- 1 Select the Location icon.
- 2 From the Project menu, select Location, then select Add Module.

2.3.2 Set Module Parameters

Notice that the contents of the information pane and the configuration pane changed when you added the MVI56-KOS150 module to the project.

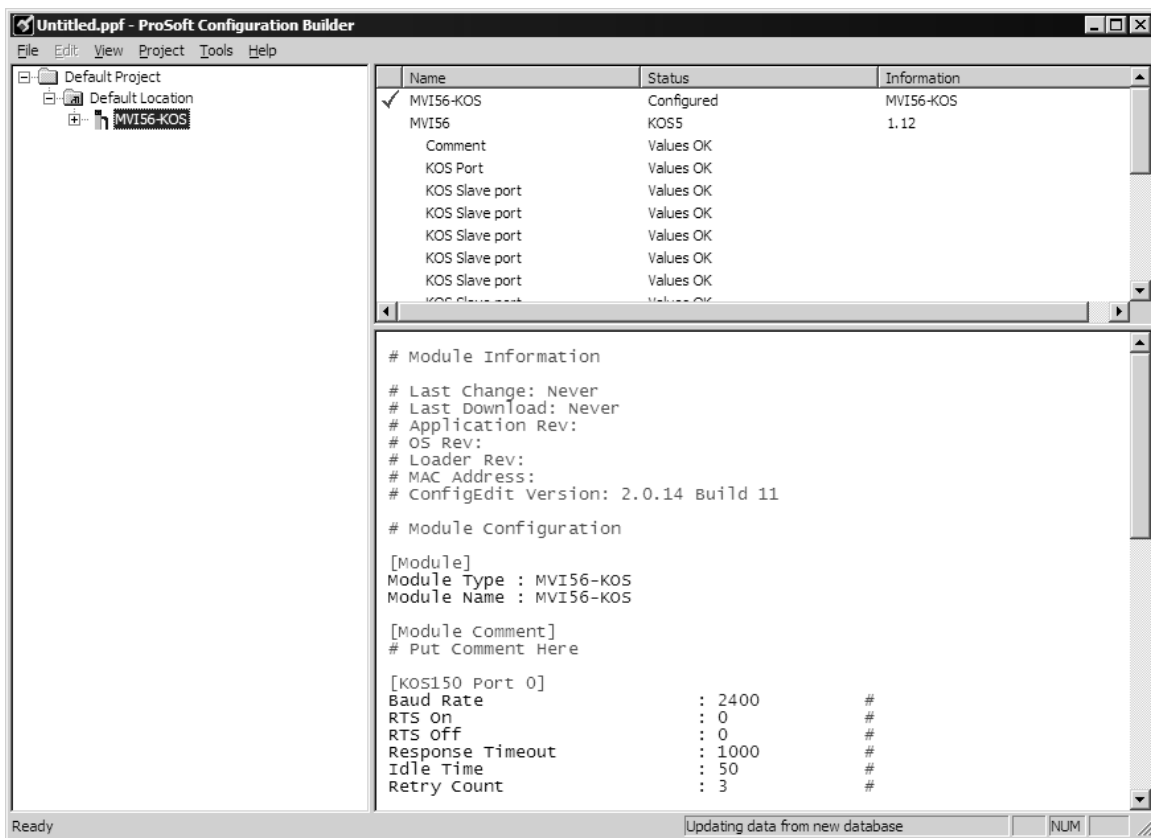



At this time, you may wish to rename the "Default Project" and "Default Location" folders in the tree view.

To rename an object:

- 1 Select the object, and then click the right mouse button to open a shortcut menu. From the shortcut menu, choose Rename.
- 2 Type the name to assign to the object.
- 3 Click away from the object to save the new name.



Module Entries

To configure module parameters

- 1 Click on the plus sign next to the icon  Comment to expand module information.
- 2 Double-click the  Module Comment icon to open the Edit dialog box.
- 3 To edit a parameter, select the parameter in the left pane and make your changes in the right pane.
- 4 Click OK to save your changes.

Comment Entries

To add comments to your configuration file:

- 1 Click the plus sign to the left of the  Comment icon to expand the Module Comments.
- 2 Double-click the  Module Comment icon. The Edit - Module Comment dialog appears.

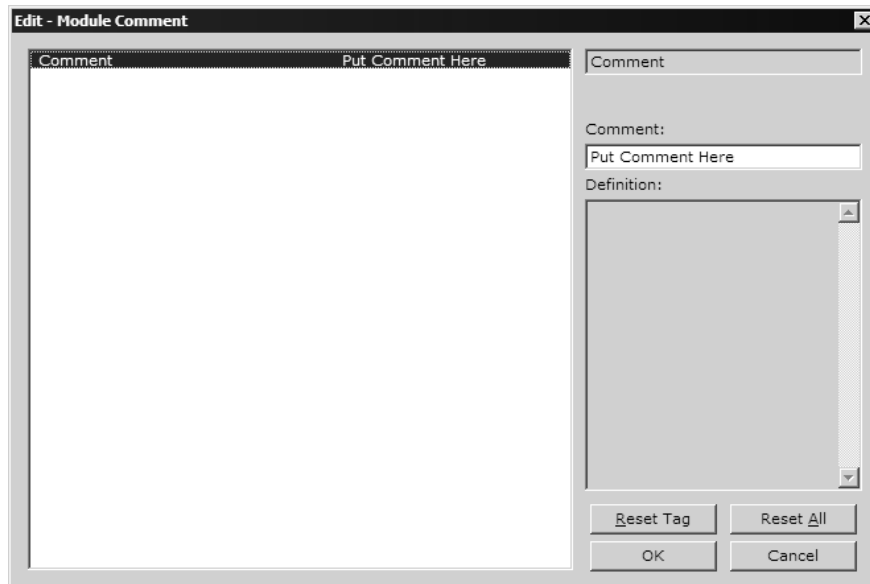

- 3 Enter your comment and click OK to save your changes.

Printing a Configuration File

To print a configuration file:

- 1 Select the Module icon, and then click the right mouse button to open a shortcut menu.
- 2 On the shortcut menu, choose View Configuration. This action opens the View Configuration window.
- 3 On the View Configuration window, open the File menu, and choose Print. This action opens the Print dialog box.
- 4 On the Print dialog box, choose the printer to use from the dropdown list, select printing options, and then click OK.

2.4 MVI56-KOS150 Configuration Data

This section contains a listing of the parameters and their definitions for the MVI56-KOS150 module configuration file definition.

Section	Value	Range	Description
[Module]			Contains the module level parameter set
Module Name:		1 to 79 characters	This parameter identifies the module on the debug port.
[KOS150 Port 0]			Contains serial port and protocol characteristics
Baud Rate:		Baud rate value	Baud Rate for the port: 110, 150, 300, 600, 1200, 2400, 4800, 9600, 19200, 384 (=38400), 576 (=57600), 115 (=115200)
RTS On:		0 to 65535	This parameter defines the number of milliseconds to hold RTS high before the CTS line must be recognized high. If the CTS line is not high before this timeout expires, a fatal error in the message will occur. This parameter is specified in milliseconds. This parameter is normally set to 40 to 50 milliseconds.
RTS Off:		0 to 65535	This parameter defines the number of milliseconds to wait after the last character is sent before dropping the RTS line. This parameter is normally set to 10 to 20 milliseconds.
Response Timeout:		100 to 65535	This parameter defines the number of milliseconds to wait for a response from a slave device after issuing a request. This value should usually be set to 1500 or greater.
Idle Time:		15 to 65535	This parameter defines the idle time defined for the network between messages when the CD line is low. This value should normally be set to 15 to 50. The parameter is in units of milliseconds.
Retry Count:		0 to 10	This parameter defines the number of retries that should be attempted if a negative response is received from the slave unit.

Section	Value	Range	Description
[KOS150 Slave 0 Port 0]			Contains the configuration for slave index 0
Enabled:		Y or N	This parameter determines if the slave will be utilized by the module. If set to yes, the slave will be used. If set to any other value, the slave will not be used.

Section	Value	Range	Description
[KOS150 Slave 1 Port 0]			Contains the configuration for slave index 1

Section	Value	Range	Description
Enabled:		Y or N	This parameter determines if the slave will be utilized by the module. If set to yes, the slave will be used. If set to any other value, the slave will not be used.

Section	Value	Range	Description
[KOS150 Slave 2 Port 0]			Contains the configuration for slave index 2
Enabled:		Y or N	This parameter determines if the slave will be utilized by the module. If set to yes, the slave will be used. If set to any other value, the slave will not be used.

Section	Value	Range	Description
[KOS150 Slave 3 Port 0]			Contains the configuration for slave index 3
Enabled:		Y or N	This parameter determines if the slave will be utilized by the module. If set to yes, the slave will be used. If set to any other value, the slave will not be used.

If there are configuration errors recognized by the module, the configuration error bits will be set. For module configuration errors, the error bits are as follows:

Bit	Description
0x0001	Invalid baud rate specified
0x0002	Invalid response timeout specified (< 100)
0x0004	Invalid idle time (< 15)
0x0008	Invalid retry count (0 to 10)
0x0010	Reserved for future use
0x8000	

For slave configuration errors word there are no configuration errors in the present version. This word may be used in future versions if required.

2.5 Download the Project to the Module

In order for the module to use the settings you configured, you must download (copy) the updated Project file from your PC to the module.

To Download the Project File

- 1 In the tree view in ProSoft Configuration Builder, click once to select the MVI56-KOS150 module.

- 2 Open the **Project menu**, and then choose **Module / Download**. The program will scan your PC for a valid com port (this may take a few seconds). When PCB has found a valid com port, the following dialog box will open.

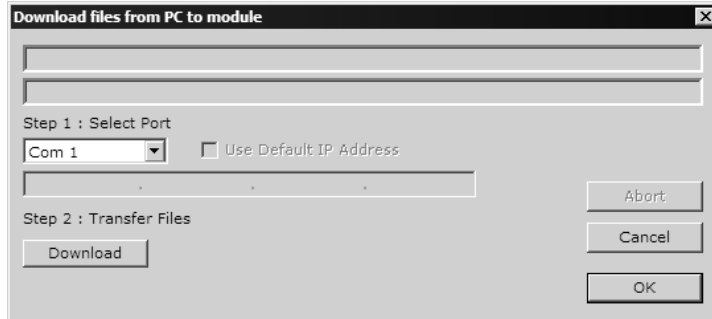

- 3 Choose the com port to use from the dropdown list, and then click the Download button.

The module will perform a platform check to read and load its new settings. When the platform check is complete, the status bar in ProSoft Configuration Builder will be updated with the message *"Module Running"*.

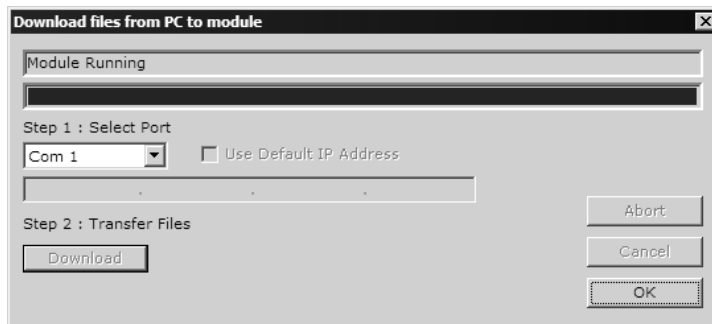

3 Ladder Logic

Ladder logic is required for application of the MVI56-KOS150 module. Tasks that must be handled by the ladder logic are module data transfer, special block handling and status data receipt. Additionally, a power-up handler may be needed to handle the initialization of the module's data and to clear any processor fault conditions.

The sample ladder logic, on the ProSoft Solutions CD-ROM, is extensively commented, to provide information on the purpose and function of each rung. For most applications, the sample ladder will work without modification.

4 Diagnostics and Troubleshooting

In This Chapter

- ❖ Reading Status Data from the Module 39
- ❖ LED Status Indicators..... 45

The module provides information on diagnostics and troubleshooting in the following forms:

- Status data values are transferred from the module to the processor.
- Data contained in the module can be viewed through the Configuration/Debug port attached to a terminal emulator.
- LED status indicators on the front of the module provide information on the module's status.

4.1 Reading Status Data from the Module

The MVI56-KOS150 module returns a status data set to the ControlLogix processor when requested by the ladder logic with a control block with a control code of 50.

The Configuration/Debug port provides the following functionality:

- Full view of the module's configuration data
- View of the module's status data
- Version Information
- Control over the module (warm boot and cold boot)
- Facility to upload and download the module's configuration file

4.1.1 Required Hardware

You can connect directly from your computer's serial port to the serial port on the module to view configuration information, perform maintenance, and send (upload) or receive (download) configuration files.

ProSoft Technology recommends the following minimum hardware to connect your computer to the module:

- 80486 based processor (Pentium preferred)
- 1 megabyte of memory
- At least one UART hardware-based serial communications port available. USB-based virtual UART systems (USB to serial port adapters) often do not function reliably, especially during binary file transfers, such as when uploading/downloading configuration files or module firmware upgrades.
- A null modem serial cable.

4.1.2 The Configuration/Debug Menu

The Configuration and Debug menu for this module is arranged as a tree structure, with the Main Menu at the top of the tree, and one or more sub-menus for each menu command. The first menu you see when you connect to the module is the Main menu.

Because this is a text-based menu system, you enter commands by typing the command letter from your computer keyboard in the diagnostic window in ProSoft Configuration Builder (PCB). The module does not respond to mouse movements or clicks. The command executes as soon as you press the command letter — you do not need to press **[Enter]**. When you type a command letter, a new screen will be displayed in your terminal application.

Using the Diagnostic Window in ProSoft Configuration Builder

To connect to the module's Configuration/Debug serial port:

- 1 Start PCB program with the application file to be tested. Right click over the module icon.

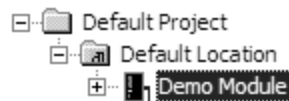

- 2 On the shortcut menu, choose Diagnostics.

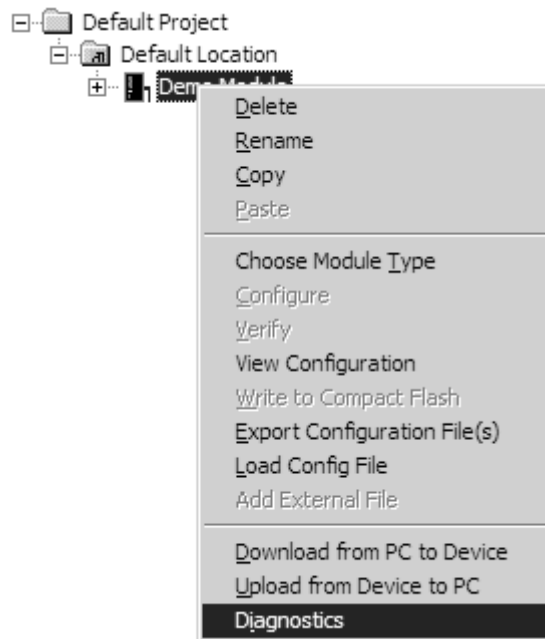

- 3 This action opens the Diagnostics dialog box. Press "?" to display the Main Menu.

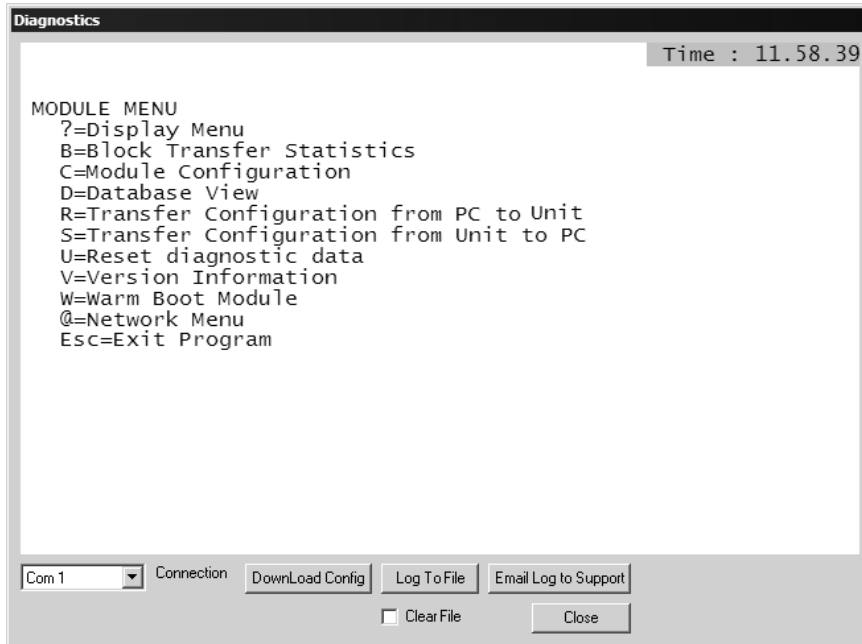

Important: The illustrations of configuration/debug menus in this section are intended as a general guide, and may not exactly match the configuration/debug menus in your own module.

If there is no response from the module, follow these steps:

- 1 Verify that the null modem cable is connected properly between your computer's serial port and the module. A regular serial cable will not work.
- 2 On computers with more than one serial port, verify that your communication program is connected to the same port that is connected to the module.

If you are still not able to establish a connection, contact ProSoft Technology for assistance.

Navigation

All of the sub-menus for this module contain commands to redisplay the menu or return to the previous menu. You can always return from a sub-menu to the next higher menu by pressing **[M]** on your keyboard.

The organization of the menu structure is represented in simplified form in the following illustration:

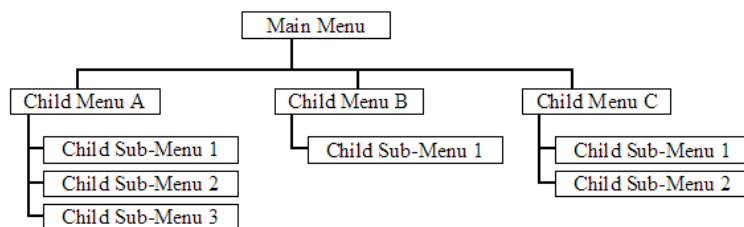

The remainder of this section shows you the menus available for this module, and briefly discusses the commands available to you.

Keystrokes

The keyboard commands on these menus are almost always non-case sensitive. You can enter most commands in lower case or capital letters.

The menus use a few special characters ([**?**], [**-**], [**+**], [**@**]) that must be entered exactly as shown. Some of these characters will require you to use the [**Shift**], [**Ctrl**] or [**Alt**] keys to enter them correctly. For example, on US English keyboards, enter the [**?**] command as [**Shift**]/.

Also, take care to distinguish capital letter [**I**] from lower case letter [**l**] (L) and number [**1**]; likewise for capital letter [**O**] and number [**0**]. Although these characters look nearly the same on the screen, they perform different actions on the module.

4.1.3 Main Menu

When you first connect to the module from your computer, your terminal screen will be blank. To activate the main menu, press the [**?**] key on your computer's keyboard. If the module is connected properly, the following menu will appear on your terminal screen:

```
MVI56-KOS150 COMMUNICATION MODULE MENU
? = Display Menu
B = Block Transfer Statistics
C = Module Configuration
R = Transfer Configuration from PC to MUI Unit
S = Transfer Configuration from MUI Unit to PC
V = Version Information
1 = Port 0 Status
6 = Port 0 Configuration
Esc = Exit Program
```

Caution: Some of the commands available to you from this menu are designed for advanced debugging and system testing only, and can cause the module to stop communicating with the processor or with other devices, resulting in potential data loss or other failures. Only use these commands if you are specifically directed to do so by ProSoft Technology Technical Support staff. Some of these command keys are not listed on the menu, but are active nevertheless. Please be careful when pressing keys so that you do not accidentally execute an unwanted command.

Viewing Block Transfer Statistics

Press [**B**] from the Main Menu to view the Block Transfer Statistics screen.

Use this command to display the configuration and statistics of the backplane data transfer operations between the module and the processor. The information on this screen can help determine if there are communication problems between the processor and the module.

Tip: To determine the number of blocks transferred each second, mark the numbers displayed at a specific time. Then some seconds later activate the command again. Subtract the previous numbers from the current numbers and divide by the quantity of seconds passed between the two readings.

Viewing Module Configuration

Press **[C]** to view the Module Configuration screen.

Use this command to display the current configuration and statistics for the module.

Transferring the Configuration File from PC to MVI56 module

Press **[R]** to send (upload) the configuration file from your PC to the module and store the file on the module's Compact Flash Disk.

Press **[Y]** to confirm the file transfer, and then follow the instructions on the terminal screen to complete the file transfer process.

After the file has been successfully downloaded, the module will restart the program and load the new configuration information. Review the new configuration using menu commands **[6]** and **[0]** to verify that the module is configured correctly.

Transferring the Configuration File from MVI56 module to PC

Press **[S]** to receive (download) the configuration file from the module to your PC.

Press **[Y]** to confirm the file transfer, and then follow the instructions on the terminal screen to complete the file transfer process.

After the file has been successfully downloaded, you can open and edit the file to change the module's configuration.

Viewing Version Information

Press **[V]** to view Version information for the module.

Use this command to view the current version of the software for the module, as well as other important values. You may be asked to provide this information when calling for technical support on the product.

Values at the bottom of the display are important in determining module operation. The Program Scan Counter value is incremented each time a module's program cycle is complete.

Tip: Repeat this command at one-second intervals to determine the frequency of program execution.

Viewing Port 0 Status

Press **[1]** to view the communication status for the port and the slaves. Use this command when trouble-shooting communication problems.

```
KOS150 PORT 0 STATUS:
CURRENT QUEUE INDEX: 0      QUEUE COUNT: 0
MODULE COMMAND STATUS COUNTERS:
REQUESTS : 9      RESPONSES: 9      ERRORS : 0
CFG ERRORS: 0x0000 CUR ERROR: 0      LAST ERROR: 0
SLAVE 0 COMMAND STATUS COUNTERS: Online Address = 1:
REQUESTS : 9      RESPONSES: 9      ERRORS : 0
CFG ERRORS: 0x0000 CUR ERROR: 0      LAST ERROR: 0
SLAVE 1 COMMAND STATUS COUNTERS: Offline Address = 0:
REQUESTS : 0      RESPONSES: 0      ERRORS : 0
CFG ERRORS: 0x0000 CUR ERROR: 0      LAST ERROR: 0
SLAVE 2 COMMAND STATUS COUNTERS: Offline Address = 0:
REQUESTS : 0      RESPONSES: 0      ERRORS : 0
CFG ERRORS: 0x0000 CUR ERROR: 0      LAST ERROR: 0
SLAVE 3 COMMAND STATUS COUNTERS: Offline Address = 0:
REQUESTS : 0      RESPONSES: 0      ERRORS : 0
CFG ERRORS: 0x0000 CUR ERROR: 0      LAST ERROR: 0
```

Viewing Port 0 Configuration

Press **[6]** to view Port 0 configuration. Use this command to view and troubleshoot communication problems between the MVI56-KOS150 and attached devices.

```
KOS150 PORT 0 CONFIGURATION:
BAUD RATE : 2400      RTS ON : 80      RTS OFF: 8
RESP TMOU: 1500     IDLE TM: 60      RETRIES: 1
SLAVE 1: Enabled: Yes Address: 1      Status: Online
SLAVE 2: Enabled: Yes Address: 2      Status: Offline
SLAVE 3: Enabled: Yes Address: 3      Status: Offline
SLAVE 4: Enabled: Yes Address: 4      Status: Offline
```

Exiting the Program

Caution: Some of the commands available to you from this menu are designed for advanced debugging and system testing only, and can cause the module to stop communicating with the processor or with other devices, resulting in potential data loss or other failures. Only use these commands if you are specifically directed to do so by ProSoft Technology Technical Support staff. Some of these command keys are not listed on the menu, but are active nevertheless. Please be careful when pressing keys so that you do not accidentally execute an unwanted command.

Press **[Esc]** to restart the module and force all drivers to be loaded. The module will use the configuration stored in the module's Flash ROM to configure the module.

4.2 LED Status Indicators

The LEDs indicate the module's operating status as follows:

ProSoft Module	Color	Status	Indication
CFG	Green	On	Data is being transferred between the module and a remote terminal using the Configuration/Debug port.
		Off	No data is being transferred on the Configuration/Debug port.
P1	Green	On	Data is being transferred between the module and the serial network (slaves)
		Off	The port is not currently active
P2	Green	On	Port not used
		Off	Port not used
APP Status	Amber	Off	The MVI56-KOS150 is working normally.
		On	The MVI56-KOS150 module program has recognized a communication error.
BP ACT	Amber	On	The LED is on when the module is performing a write operation on the backplane.
		Off	The LED is off when the module is performing a read operation on the backplane. Under normal operation, the LED should blink rapidly on and off.
OK	Red/ Green	Off	The card is not receiving any power and is not securely plugged into the rack.
		Green	The module is operating normally.
		Red	The program has detected an error or is being configured. If the LED remains red for over 10 seconds, the program has probably halted. Remove the card from the rack and re-insert the card to restart the module's program.
BAT	Red	Off	The battery voltage is OK and functioning.
		On	The battery voltage is low or battery is not present. Allow battery to charge by keeping module plugged into rack for 24 hours. If BAT LED still does not go off, contact ProSoft Technology, as this is not a user serviceable item.

4.2.1 Clearing a Fault Condition

Typically, if the OK LED on the front of the module turns red for more than ten seconds, a hardware problem has been detected in the module, or the program has exited.

To clear the condition, follow these steps:

- 1 Turn off power to the rack
- 2 Remove the card from the rack
- 3 Verify that all jumpers are set correctly
- 4 If the module requires a Compact Flash card, verify that the card is installed correctly
- 5 Re-insert the card in the rack and turn the power back on
- 6 Verify the configuration data being transferred to the module from the ControlLogix processor.

If the module's OK LED does not turn green, verify that the module is inserted completely into the rack. If this does not cure the problem, contact ProSoft Technology Support.

4.2.2 Troubleshooting

Use the following troubleshooting steps if you encounter problems when the module is powered up. If these steps do not resolve your problem, please contact ProSoft Technology Technical Support.

Processor Errors

Problem Description	Steps to take
Processor Fault	Verify that the module is plugged into the slot that has been configured for the module. Verify that the slot in the rack configuration has been set up correctly in the ladder logic.
Processor I/O LED flashes	This indicates a problem with backplane communications. Verify that all modules in the rack are configured in the ladder logic.

Module Errors

Problem Description	Steps to take
BP ACT LED remains off or blinks slowly	This indicates that backplane transfer operations are failing. Connect to the module's Configuration/Debug port to check this. To establish backplane communications, verify the following items: <ul style="list-style-type: none">▪ The processor is in Run mode.▪ The backplane driver is loaded in the module.▪ The module is configured for read and write block data transfer.▪ The ladder logic handles all read and write block situations.▪ The module is configured in the processor.
OK LED remains red	The program has halted or a critical error has occurred. Connect to the Configuration/Debug port to see if the module is running. If the program has halted, turn off power to the rack, remove the card from the rack and re-insert the card in the rack, and then restore power to the rack.

5 Reference

In This Chapter

❖ Product Specifications	47
❖ Functional Overview	49
❖ Cable Connections	59

5.1 Product Specifications

The MVI56 KOS 150 Communication Protocol Module allows Rockwell Automation ControlLogix I/O compatible processors to interface easily with KOS 150 Communication Protocol devices over a serial network.

5.1.1 Features and Benefits

The MVI56-KOS150 module interfaces a serial communication device using the KOS 150 Communication Protocol with the Rockwell Automation ControlLogix processor. A single serial port is present on the module to interface with one to four devices. The serial port acts as a master device polling and sending commands to the slave devices. Ladder logic in the ControlLogix processor completely handles all messages sent out the serial port and is responsible for processing all received messages. The KOS 150 driver in the module is responsible for building the messages from a queue controlled by the ladder logic and sending and receiving all messages between the module and the slaves. Data and errors received on the serial port are passed from the module to the user ladder logic for processing.

5.1.2 General Specifications

- Single Slot - 1756 backplane compatible
- The module is recognized as an Input/Output module and has access to processor memory for data transfer between processor and module
- Ladder Logic is used for data transfer between module and processor. Sample ladder file included.
- Configuration data obtained from configuration text file downloaded to module. Sample configuration file included
- Local or remote rack

5.1.3 Hardware Specifications

Specification	Description
Backplane Current Load	800 mA @ 5 V DC 3mA @ 24V DC
Operating Temperature	0 to 60°C (32 to 140°F)
Storage Temperature	-40 to 85°C (-40 to 185°F)
Shock	30g Operational 50g non-operational Vibration: 5 g from 10 to 150 Hz
Relative Humidity	5% to 95% (non-condensing)
LED Indicators	Module Status Backplane Transfer Status Application Status Serial Activity
Debug/Configuration port (CFG)	
CFG Port (CFG)	RJ45 (DB-9M with supplied cable) RS-232 only
Application ports (PRT1 & PRT2)	
Full hardware handshaking control, providing radio, modem and multi-drop support	
Software configurable communication parameters	Baud rate: 110 to 115,200 baud, depending on protocol RS-232 and 422 Parity: none, odd or even Data bits: 5, 6, 7, or 8 Stop bits: 1 or 2 RTS on/off delay: 0 to 65535 milliseconds
App Ports (P1,P2) (Serial modules)	RJ45 (DB-9M with supplied cable) RS-232 handshaking configurable 500V Optical isolation from backplane
Shipped with Unit	RJ45 to DB-9M cables for each port 6-foot RS-232 configuration cable

5.1.4 Functional Specifications

Some of the general specifications include:

- One serial port to issue and receive KOS 150 protocol messages. This driver uses a command queue of 3 maximum messages.
- Data exchange between the ControlLogix processor and the MVI module is optimized for use on a Control Net network.
- Configurable parameters for the serial interface include:
 - All timing parameters
 - Retry count
 - Slave node enable and addressing
- The module contains a debug/configuration port to monitor status and to upload and download the module's configuration.

5.2 Functional Overview

This section provides an overview of how the MVI56-KOS150 module transfers data using the KOS protocol. You should understand the important concepts in this chapter before you begin installing and configuring the module.

5.2.1 General Concepts

The following discussion explains several concepts that are important for understanding the operation of the MVI56-KOS150 module.

Module Power Up

On power up, the module begins performing the following logical functions:

- 1 Initialize hardware components
 - Initialize ControlLogix backplane driver
 - Test and clear all RAM
 - Initialize the serial communication ports
- 2 Read configuration for module from KOS150.CFG file on Compact Flash Disk
- 3 Initialize the application serial port
- 4 Set up the serial communication interface for the debug/configuration port

After the module has received the configuration, the module will be ready to receive messages from the user ladder logic.

Main Logic Loop

Upon completing the power up configuration process, the module enters an infinite loop that performs the following functions:

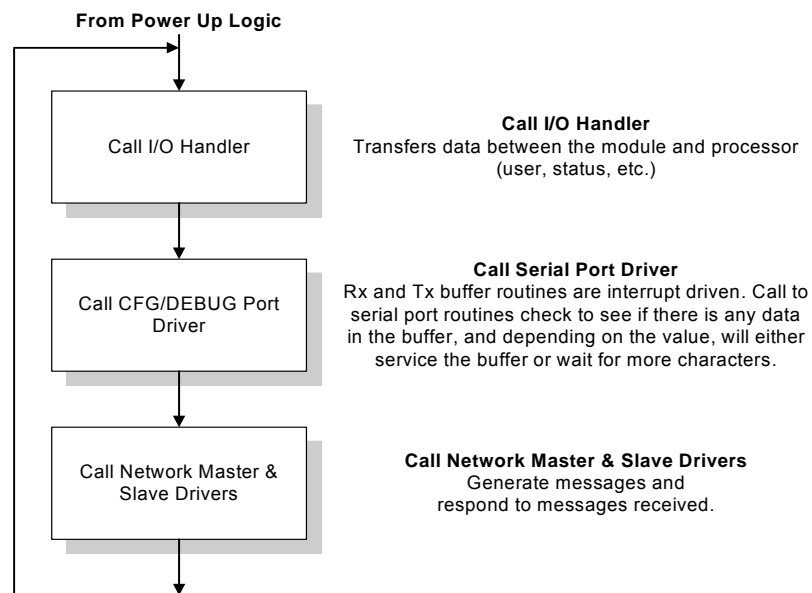

Backplane Data Transfer

The MVI56-KOS150 module communicates directly over the ControlLogix backplane. Data travels between the module and the ControlLogix processor across the backplane using the module's input and output images. The update frequency of the data is determined by the scan rate defined by the user for the module and the communication load on the module. Typical updates are in the range of 1 to 10 milliseconds.

Data received by the module is placed in the module's input image. This data is processed by the ladder logic in the ControlLogix processor. The input image for the module is set to 266 bytes. This data area permits fast throughput between the module and the processor and permits space for the maximum response message.

The processor's ladder logic inserts data in the module's output image to transfer to the module. Command messages received are placed in the command queue of the module. This queue can hold up to three commands. The module's program extracts messages from the queue and constructs KOS 150 protocol messages to send out the serial port. The output image for the module is set to 60 bytes. This data area permits fast throughput of data from the processor to the module and is large enough to hold the largest request message.

The following illustration shows the data transfer method used to move data between the ControlLogix processor, the MVI56-KOS150 module, and the serial network.

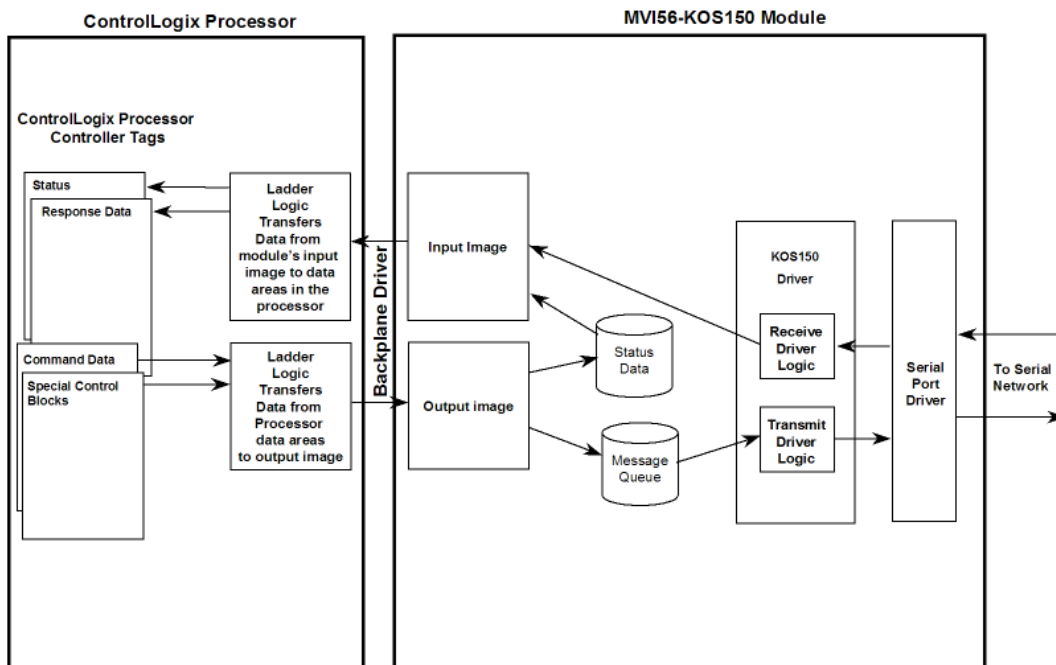

As shown in the previous diagram, all data transferred between the module and the processor over the backplane is through the input and output images. Ladder logic must be written in the ControlLogix processor to interface the input and output image data to the user defined controller tags. The user is responsible for handling and interpreting all data received on the application port and transferred to the input image. Additionally, the user is responsible for constructing messages to be transferred out of the module by building the messages in the output image of the module

Normal Data Transfer

Normal data transfer includes the transferring of data received by or to be transmitted from the module and the status data. These data are transferred through read (input image) and write (output image) blocks. Refer to Module Configuration for a description of the data objects used with the blocks and the ladder logic required. The following topics discuss the structure and function of each block.

Read Block

These blocks of data transfer information from the module to the ControlLogix processor. The structure of the input image used to transfer this data is shown in the following table:

Offset	Definition
0	Number of commands in queue
1	Type (0=Control or 1=Command Port 0)
2 to 264	Block data
265	Sequence Number for block (0 to 255)

The Block Sequence Number (byte 265) is an index value used to signal to the ControlLogix processor that a new block is ready for processing. The ladder logic must recognize a change in this value and process the data encapsulated in the input image. If data is available, the ladder logic must determine the content type and place the data in the correct controller tags. Byte 1 in the block defines if the block contains control data or command response data. The format of the command block is as follows:

Offset	Definition								
0	Reserved								
1	Type (1= Command Port 0)								
2	Message identification code (1 to 255)								
3	Status (0=Ack, 1=Data, 2=Nack, 3=Err)								
	<table border="1"> <tbody> <tr> <td>0</td> <td>Single ACK received</td> </tr> <tr> <td>1</td> <td>Data response (control function 8)</td> </tr> <tr> <td>2</td> <td>Error received (control function 1 or 9)</td> </tr> <tr> <td>3</td> <td>Driver error recognized</td> </tr> </tbody> </table>	0	Single ACK received	1	Data response (control function 8)	2	Error received (control function 1 or 9)	3	Driver error recognized
0	Single ACK received								
1	Data response (control function 8)								
2	Error received (control function 1 or 9)								
3	Driver error recognized								
4	Length of message								

Offset	Definition								
5	Control function (0, 1, 8 or 9)								
	<table border="1"> <tr> <td>0</td> <td>None for message</td> </tr> <tr> <td>1</td> <td>NACK to send/confirm</td> </tr> <tr> <td>8</td> <td>Response to request/response</td> </tr> <tr> <td>9</td> <td>NAC to request/response</td> </tr> </table>	0	None for message	1	NACK to send/confirm	8	Response to request/response	9	NAC to request/response
0	None for message								
1	NACK to send/confirm								
8	Response to request/response								
9	NAC to request/response								
6	Slave index 0 to 3								
7	Reserved								
8	Type identification code (1 to 255)								
9 to 264	ASDU Data								
265	Sequence Number for block (0 to 255)								

Byte 2 of the message contains the message identification code passed to the module as specified in the request from the ladder logic. This byte can be used to match requests with responses. Byte 3 determines if the command requested was executed successfully. If the return value is 0, the command was executed as a Send/Confirm message and the request was successful with no data in the returned message. If a value of 1 is returned, the message was executed successfully and the input image contains the response data. If a value of 2 is returned, there was a protocol error returned from the slave device. The data in the ASDU (bytes 8 to 264) contain the error response message. Refer to the protocol document for the structure of this response message and a complete list of all error numbers. If a value of 3 is returned, there was an error found in the message by the driver. The following table lists the module driver errors returned:

Error Code	Definition
0	No error
1	RTS on timer expired before CTS detected
2	Response message too long from subsea unit
3	No CD when waiting for response
4	Response timeout
5	Check byte error
6	Message queue is full
7	Invalid slave index in block (0 to 3)
8	Invalid length specified (11 to 50)
9	Invalid ASDU code or message id (1 to 255)
10	Invalid control function code (1, 3 or 11)
11	Could not get FCB synchronized

If a value of 1 is returned for byte 3, byte 4 contains the length of data in the response message. This length includes all bytes from byte 5 in the message to the end of the ASDU. Refer to the protocol documentation to determine how to parse the response message data. The ASDU starts at byte 8 and is as presented in the protocol documentation.

The only control block sent from the module to the processor, the status block (50), which must be handled by the ladder logic has the following format:

Offset	Definition
0	Reserved
1	0
2	50
3	Last message identification code
4	Program scan counter
6	Product code
10	Revision
14	Operating system level
18	Run number
22	Read block count
24	Write block count
26	Error block count
28	Control block count read
30	Control block count write
32	Command block count read
34	Command block count write
Module	
36	Command requests
38	Command responses
40	Command errors
42	Configuration error
44	Current error
46	Last error
Unit 1	
48	Enabled
50	Address
52	Control bit (FCB)
54	Command requests
56	Command responses
58	Command errors
60	Configuration error
62	Current error
64	Last error
Unit 2	
66	Enabled
68	Address
70	Control bit (FCB)
72	Command requests
74	Command responses

Offset	Definition
76	Command errors
78	Configuration error
80	Current error
82	Last error
Unit 3	
84	Enabled
86	Address
88	Control bit (FCB)
90	Command requests
92	Command responses
94	Command errors
96	Configuration error
98	Current error
100	Last error
Unit 4	
102	Enabled
104	Address
106	Control bit (FCB)
108	Command requests
110	Command responses
112	Command errors
114	Configuration error
116	Current error
118	Last error
Common	
120	Current queue index
122	Number in queue
124 to 264	Reserved
265	Sequence Number for block (0 to 255)

The ladder logic should place this information into the correct controller tags of the user application. A control request for this information should be executed periodically to retrieve this block of information.

The last byte of the input image (byte 265) is the block sequence number. This byte's value is changed each time the module has processed the previous output image or is sending new information to the processor. This value should be copied to the first byte of the output image (write block sequence number). Using this sequence number, the arrival of new data can easily be recognized by both the processor and the module.

Write Block

These blocks of data transfer information from the ControlLogix processor to the module. The structure of the output image used to transfer this data is shown in the following table.

Offset	Definition
0	Sequence Number for block (0 to 255)
1	Type (0=Control or 1=Command)
2 to 57	Block data
58 to 59	Slave Address for command

The Block Sequence Number is that received on the last read block transfer through the input image on the module. The ladder logic should copy this value from byte 265 of the input image to byte 0 of output image in the ladder logic. This is the last operation performed when constructing the write block. The module's program will trigger the process write block function when a new value is recognized in byte 0 of the output image.

Byte 1 of the block determines if the block contains control or command message data. If the byte contains a value of 0, the block contains control data with the value in byte 2 determining the control function to be performed. The following table lists the valid values for control blocks:

Code	Definition
0	No operation
50	Status block
90	Set slave offline
99	Cold boot request

When no operation is to be performed and no command message is ready for the module, the ladder logic should use control blocks with code 0 to pass control from the processor back to the module. The format for control block 90 to set a slave offline is as follows:

Offset	Definition
0	Sequence Number for block (0 to 255)
1	0
2	90
3	Slave index (0 to 3) to place offline
4 to 59	No data in write block

After the module processes the block, it will return a block with the following format:

Offset	Definition
0	Number of commands in queue
1	0
2	90
3	Slave index (0 to 3) to placed offline or -1 if error.
4 to 264	No data in write block
265	Sequence Number for block (0 to 255)

If the slave index specified in the request block is out of range (<0 or >3), the module will return with a value of -1 in the slave index field to indicate the error.

If byte 1 of the write block is set to 1, the block contains a command message to be sent to a specific slave on the serial network. The format of this block must be as defined in the protocol definition documentation in order for the module to execute it correctly. When the module receives a command message block, it will validate the parameters of the block to make sure they are correct. If an error is found, an output block will be generated containing the driver-recognized error. If the message is valid, the driver will add the message to the command queue for execution. Up to three commands can be present in the command queue ready for execution. The format of a command message block is as follows:

Offset	Definition						
0	Sequence Number for block (0 to 255)						
1	Type (1= Command Port 0)						
2	Message identification code (1 to 255)						
3	Reserved						
4	Length of message						
5	Control function (1, 3 or 11)						
	<table border="1"> <tbody> <tr> <td>1</td> <td>Send/Confirm (Reset)</td> </tr> <tr> <td>3</td> <td>Send/Confirm</td> </tr> <tr> <td>11</td> <td>Request/Response</td> </tr> </tbody> </table>	1	Send/Confirm (Reset)	3	Send/Confirm	11	Request/Response
1	Send/Confirm (Reset)						
3	Send/Confirm						
11	Request/Response						
6	Slave index 0 to 3						
7	Reserved						
8	Type identification code (1 to 255)						
9 to 57	ASDU Data						
58 to 59	Slave address to consider with command						

Byte 2 of the message can be used by the ladder logic to match request and response messages. The length specified in byte 4 is the number of data bytes in the message starting at byte 8 in the block. The minimum length for a message is 11 for this parameter as specified in the protocol specification. Any unused bytes in the message should be set to 0. The maximum length value that can be specified for a block is 50 as this is the number of bytes from byte 8 to 57 of the block. The protocol specification must be consulted to determine the proper values for the length, control, type identification code and ASDU data. Byte 6 selects the slave index to be used to send the message to. Up to four slaves can be defined for the module indexes 0 to 3 as defined in the configuration file.

Bytes 58 to 59 define the slave address for the message. This will be the address used in the message sent out the serial port. The value entered will be stored with the slave index passed in the block. When the module recognizes that the address specified in bytes 58 to 59 is different, the module will store the new address and set the slave to the offline status. This will cause the module to synchronize the FCB for the new slave. This feature insulates the user from the lower level of the protocol and makes the module easier to use.

Data Flow

This section describes the flow of data blocks between the ControlLogix processor and the remote slaves. Ladder logic in the ControlLogix processor is responsible for generating requests and parsing messages received from the slaves. The parsed data from the received messages are placed in the controller tags of the processor.

The following illustration shows the data flow for a request message:

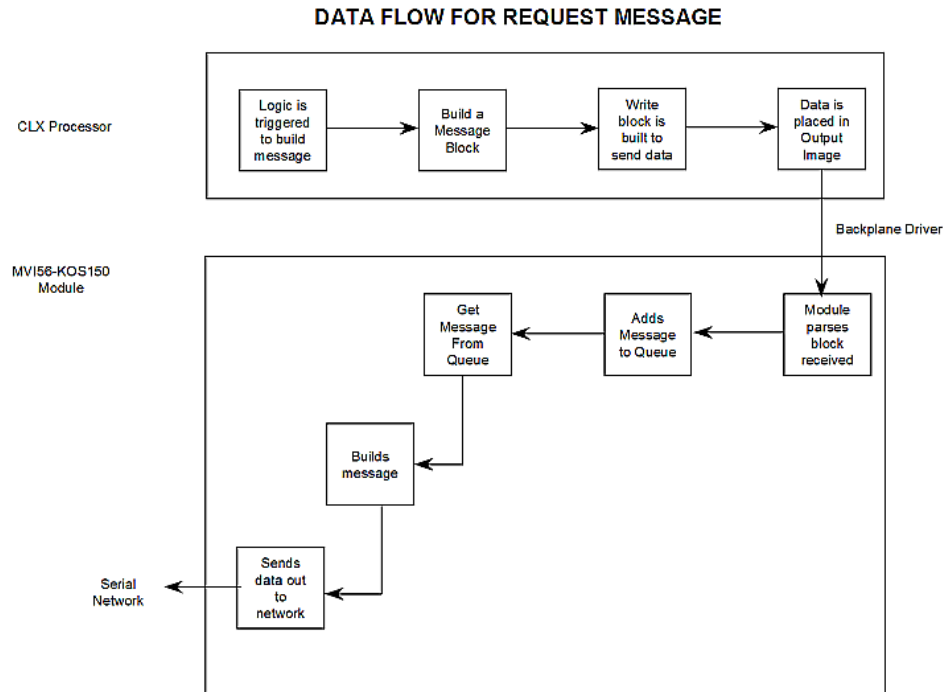

The ladder logic determines when a request message is to be built. This request can be triggered by an external or internal event in the processor. It is the responsibility of the application engineer to construct ladder logic for each request message to be sent to the remote slaves.

The following illustration shows the data flow for a response message:

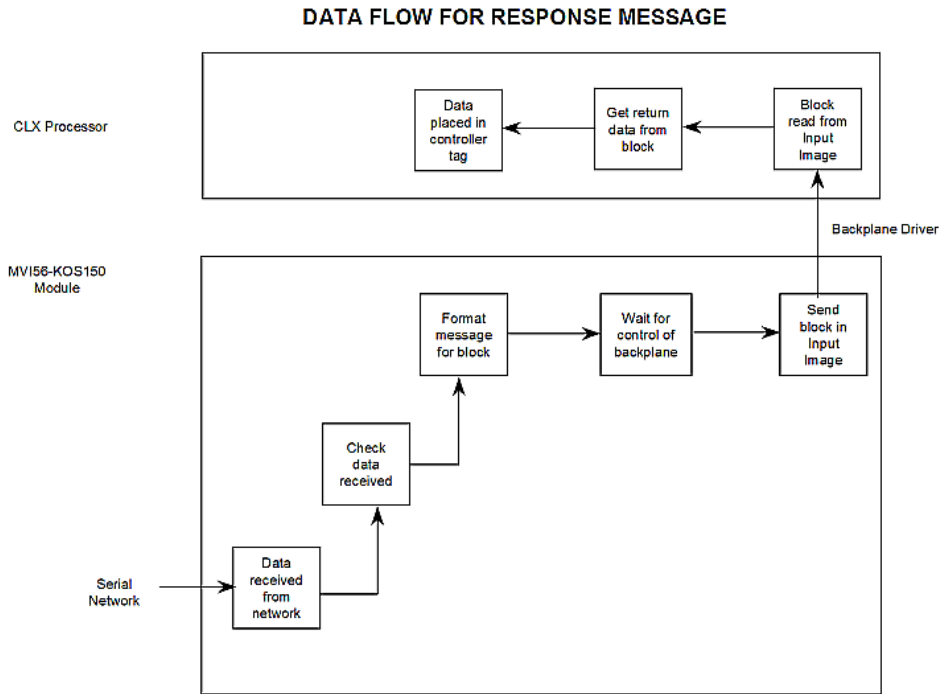

The remote slave unit generates the response message. It will only be generated in response to a request message sent from the ladder logic. Ladder logic is responsible for parsing each data block received over the backplane and for placing the data in the correct controller tags.

Data Storage

All data utilized by the module is stored in the ControlLogix processor. It is the responsibility of the ladder logic program to define the method to build and parse messages. The storage of the data is completely up to the application programmer. The data can be stored as arrays for each data type, can be stored as arrays of objects or can be stored as individual tags. The ladder logic will use this data to trigger when messages must be requested and will store the response information into the areas. The user can also define an error log to store the error codes returned for each request. The simplicity or complexity of the application is left for the user to define.

5.3 Cable Connections

The application ports on the MVI56-KOS150 module support RS-232 interfaces. Please look at the module to ensure that the jumpers are set correctly to correspond with the type of interface you are using. The following diagrams show the cable configurations for the various interfaces:

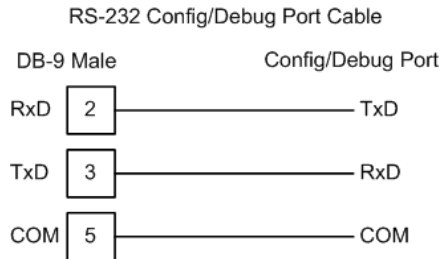

Note: When using RS-232 with radio modem applications, the module requires hardware handshaking.

5.3.1 RS-232

When the RS-232 interface is selected, the use of hardware handshaking (control and monitoring of modem signal lines) is user definable. If no hardware handshaking will be used, the cable to connect to the port is as shown below:

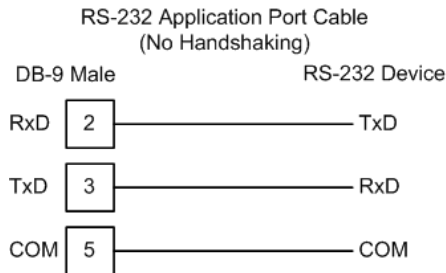

RS-232: Modem Connection

This type of connection is required between the module and a modem or other communication device.

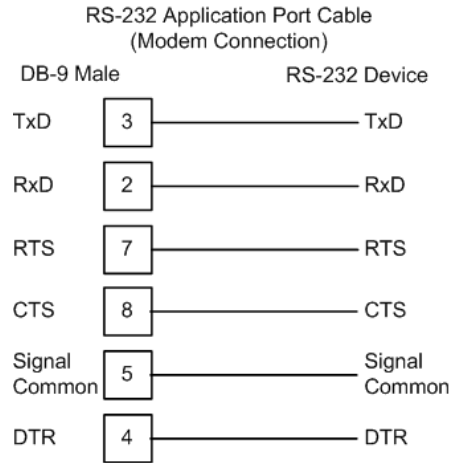

The "Use CTS Line" parameter for the port configuration should be set to 'Y' for most modem applications.

RS-232: Null Modem Connection (Hardware Handshaking)

This type of connection is used when the device connected to the module requires hardware handshaking (control and monitoring of modem signal lines).

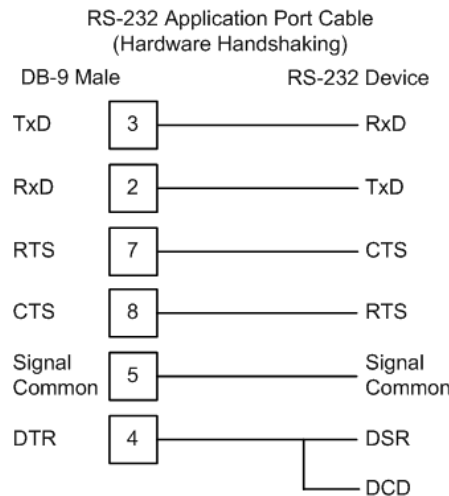

RS-232: Null Modem Connection (No Hardware Handshaking)

This type of connection can be used to connect the module to a computer or field device communication port.

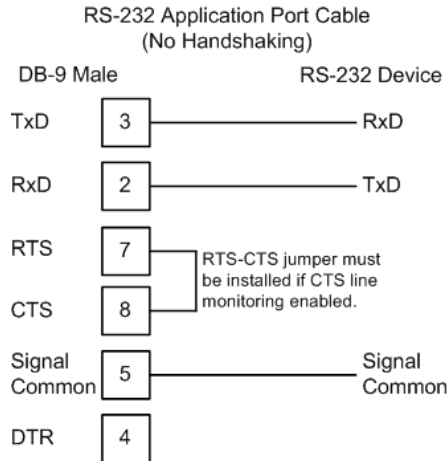

Note: If the port is configured with the "Use CTS Line" set to 'Y', then a jumper is required between the RTS and the CTS line on the module connection.

5.3.2 RS-232 Configuration/Debug Port

This port is physically an RJ45 connection. An RJ45 to DB-9 adapter cable is included with the module. This port permits a PC based terminal emulation program to view configuration and status data in the module and to control the module. The cable for communications on this port is shown in the following diagram:

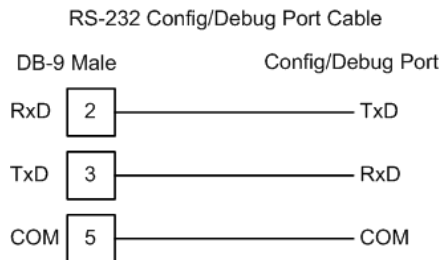
**Disabling the RSLinx Driver for the Com Port on the PC**

The communication port driver in RSLinx can occasionally prevent other applications from using the PC's COM port. If you are not able to connect to the module's configuration/debug port using ProSoft Configuration Builder (PCB), HyperTerminal or another terminal emulator, follow these steps to disable the RSLinx Driver.

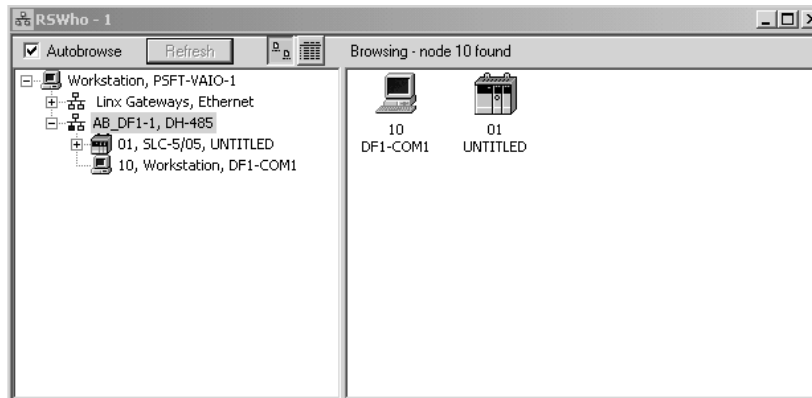

- 1 Open RSLinx and go to Communications>RSWho

- 2 Make sure that you are not actively browsing using the driver that you wish to stop. The following shows an actively browsed network:

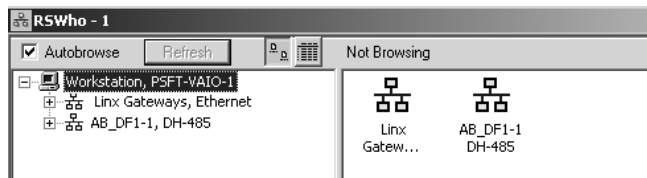

- 3 Notice how the DF1 driver is opened, and the driver is looking for a processor on node 1. If the network is being browsed, then you will not be able to stop this driver. To stop the driver your RSWHo screen should look like this:



Branches are displayed or hidden by clicking on the  or the  icons.

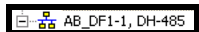

- 4 When you have verified that the driver is not being browsed, go to **Communications>Configure Drivers**
You may see something like this:

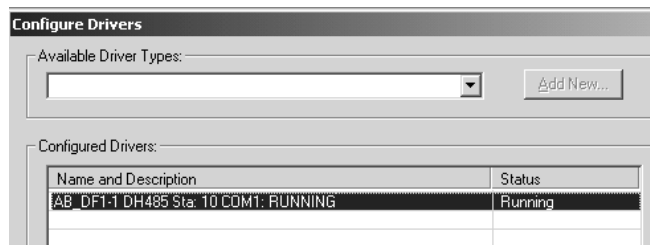

If you see the status as running, you will not be able to use this com port for anything other than communication to the processor. To stop the driver press the "Stop" on the side of the window:



5 After you have stopped the driver you will see the following:

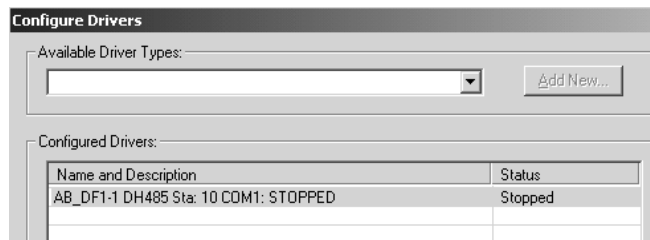

6 Upon seeing this, you may now use that com port to connect to the debug port of the module.

Note: You may need to shut down and restart your PC before it will allow you to stop the driver (usually only on Windows NT machines). If you have followed all of the above steps, and it will not stop the driver, then make sure you do not have RSLogix open. If RSLogix is not open, and you still cannot stop the driver, then reboot your PC.

5.3.3 DB9 to RJ45 Adaptor (Cable 14)

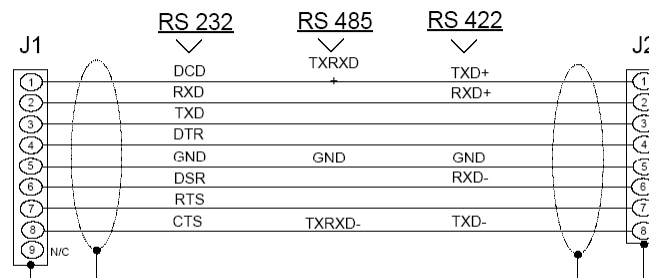
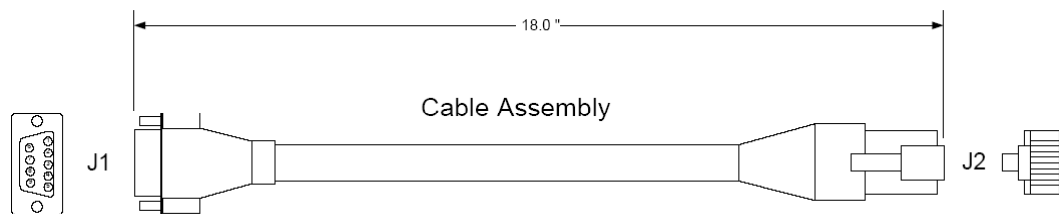

Wiring Diagram

6 Support, Service & Warranty

In This Chapter

- ❖ How to Contact Us: Sales and Support 66
- ❖ Return Material Authorization (RMA) Policies and Conditions..... 66
- ❖ Procedures for Return of Units Under Warranty 67
- ❖ Procedures for Return of Units Out of Warranty 68
- ❖ LIMITED WARRANTY 69

Be sure and read the full Warranty that can be found on our web site at www.prosoft-technology.com for details and other terms and conditions. The content in this summary is subject to change without notice. The content is current at date of publication.

ProSoft Technology, Inc. strives to provide meaningful support to its customers. Should any questions or problems arise, please feel free to contact us at:

Internet	Web Site: http://www.prosoft-technology.com/support
	E-mail address: support@prosoft-technology.com

Those of us at ProSoft Technology, Inc. want to provide the best and quickest support possible, so before calling please have the following information available. You may wish to fax this information to us prior to calling.

- 1 Product Version Number
- 2 System architecture
- 3 Network details

In the case of hardware, we will also need the following information:

- 1 Module configuration and contents of file
- 2 Module Operation
- 3 Configuration/Debug status information
- 4 LED patterns
- 5 Information about the processor and user data files as viewed through the development software and LED patterns on the processor
- 6 Details about the networked devices interfaced, if any

For technical support calls within the United States, an after-hours answering system allows pager access to one of our qualified technical and/or application support engineers at any time to answer your questions.

6.1 How to Contact Us: Sales and Support

All ProSoft Technology Products are backed with full technical support. Contact our worldwide Technical Support team and Customer Service representatives directly by phone or email:

USA / Latin America (excluding Brasil) (Office in California)

+1(661) 716-5100
+1(661) 716-5101 (Fax)
1675 Chester Avenue, 4th Floor
Bakersfield, California 93301
U.S.A.
+1.661.716.5100, support@prosoft-technology.com
Languages spoken include: English, Spanish

Asia Pacific Sales (office in Malaysia)

+603.7724.2080
+603.7724.2090 (Fax)
C210, Damansara Intan,
1 Jalan SS20/27, 47400 Petaling Jaya
Selangor, Malaysia
+603.7724.2080, asiapc@prosoft-technology.com
Languages spoken include: Chinese, Japanese, English

Asia Pacific Support (office in China)

+86.21.64518356 x 8011
+86.21.64756957 (Fax)
4/F, No. 16 Hongcao Road
Shanghai, China 200233
China
+86.21.64518356 x 8011, zhang@prosoft-technology.com
Languages spoken include: Chinese, English

Europe / Middle East / Africa (office in Toulouse, France)

+33 (0) 5.34.36.87.20
+33 (0) 5.61.78.40.52 (Fax)
Zone d'activité de Font Grasse
17, rue des Briquetiers
F-31700 Blagnac
France
+33 (0) 5.34.36.87.20. support.emea@prosoft-technology.com
Languages spoken include: French, English

Brasil (office in Sao Paulo)

+55-11-5084-5178
+55-11-5083-3776 (Fax)
Rua Vergueiro, 2949 - sala 182 - Edifício Vergueiro Work Center
Vila Mariana - São Paulo
Cep: 04101-300 - Brasil
+55-11-5084-5178, eduardo@prosoft-technology.com
Languages spoken include: Portuguese, English

6.2 Return Material Authorization (RMA) Policies and Conditions

The following RMA Policies and Conditions apply to any returned product. These RMA Policies are subject to change by ProSoft without notice. For warranty information, see Section C below entitled "Limited Warranty". In the event of any inconsistency between the RMA Policies and the Warranty, the Warranty shall govern.

6.2.1 All Product Returns

- 1** In order to return a Product for repair, exchange or otherwise, the Customer must obtain a Returned Material Authorization (RMA) number from ProSoft and comply with ProSoft shipping instructions.
- 2** In the event that the Customer experiences a problem with the Product for any reason, Customer should contact ProSoft Technical Support at one of the telephone numbers listed above in Section A. A Technical Support Engineer will request several tests in an attempt to isolate the problem. If after these tests are completed, the Product is found to be the source of the problem, ProSoft will issue an RMA.
- 3** All returned Products must be shipped freight prepaid, in the original shipping container or equivalent, to the location specified by ProSoft, and be accompanied by proof of purchase. The RMA number is to be prominently marked on the outside of the shipping box. Customer agrees to insure the Product or assume the risk of loss or damage in transit. Products shipped to ProSoft without an RMA number will be returned to the Customer, freight collect. Contact ProSoft Technical Support for further information.
- 4** Out of warranty returns are not allowed on RadioLinX accessories such as antennas, cables, and brackets.

The following policy applies for Non-Warranty Credit Returns:

- A** 10% Restocking Fee if Factory Seal is *not* broken
- B** 20% Restocking Fee if Factory Seal is broken

ProSoft retains the right, in its absolute and sole discretion, to reject any non-warranty returns for credit if the return is not requested within three (3) months after shipment of the Product to Customer, if the Customer fails to comply with ProSoft's shipping instructions, or if the Customer fails to return the Product to ProSoft within six (6) months after Product was originally shipped.

6.3 Procedures for Return of Units Under Warranty

- 1** A Technical Support Engineer must pre-approve all product returns.
- 2** Module is repaired or replaced after a Return Material Authorization Number is entered and a replacement order is generated.
- 3** Credit for the warranted item is issued within 10 business days after receipt of product and evaluation of the defect has been performed by ProSoft. The credit will only be issued provided the product is returned with a valid Return Material Authorization Number and in accordance with ProSoft's shipping instructions.

- a) If no defect is found, a credit is issued.
- b) If a defect is found and is determined to be customer generated or if the defect is otherwise not covered by ProSoft's Warranty, or if the module is not repairable, a credit is not issued and payment of the replacement module is due.

6.4 Procedures for Return of Units Out of Warranty

- 1 Customer sends unit in for evaluation.
- 2 If no defect is found, Customer will be charged the equivalent of US \$100 plus shipping, duties and taxes that may apply. A new Purchase Order will be required for this evaluation fee.

If the unit is repaired the charge to the Customer will be 30%* of the list price plus any shipping, duties and taxes that may apply. A new Purchase Order will be required for a product repair.

- 3 For an immediate exchange, a new module may be purchased and sent to Customer while repair work is being performed. Credit for purchase of the new module will be issued when the new module is returned in accordance with ProSoft's shipping instructions and subject to ProSoft's policy on non-warranty returns. This is in addition to charges for repair of the old module and any associated charges to Customer.
- 4 If, upon contacting ProSoft Customer Service, the Customer is informed that unit is believed to be unrepairable, the Customer may choose to send unit in for evaluation to determine if the repair can be made. Customer will pay shipping, duties and taxes that may apply. If unit cannot be repaired, the Customer may purchase a new unit.

6.4.1 Un-repairable Units

- 3150-All
- 3750
- 3600-All
- 3700
- 3170-All
- 3250
- 1560 can be repaired, if defect is the power supply
- 1550 can be repaired, if defect is the power supply
- 3350
- 3300
- 1500-All

*** 30% of list price is an estimated repair cost only. The actual cost of repairs will be determined when the module is received by ProSoft and evaluated for needed repairs.**

6.4.2 Purchasing Warranty Extension

As detailed below in ProSoft's Warranty, the standard Warranty Period is one year (or in the case of RadioLinx modules, three years) from the date of delivery. The Warranty Period may be extended for an additional charge, as follows:

- Additional 1 year = 10% of list price
- Additional 2 years = 20% of list price
- Additional 3 years = 30% of list price

6.5 LIMITED WARRANTY

This Limited Warranty ("Warranty") governs all sales of hardware, software and other products (collectively, "Product") manufactured and/or offered for sale by ProSoft, and all related services provided by ProSoft, including maintenance, repair, warranty exchange, and service programs (collectively, "Services"). By purchasing or using the Product or Services, the individual or entity purchasing or using the Product or Services ("Customer") agrees to all of the terms and provisions (collectively, the "Terms") of this Limited Warranty. All sales of software or other intellectual property are, in addition, subject to any license agreement accompanying such software or other intellectual property.

6.5.1 What Is Covered By This Warranty

A *Warranty On New Products:* ProSoft warrants, to the original purchaser only, that the Product that is the subject of the sale will (1) conform to and perform in accordance with published specifications prepared, approved, and issued by ProSoft, and (2) will be free from defects in material or workmanship; provided these warranties only cover Product that is sold as new. This Warranty expires one year (or in the case of RadioLinx modules, three years) from the date of shipment (the "Warranty Period"). If the Customer discovers within the Warranty Period a failure of the Product to conform to specifications, or a defect in material or workmanship of the Product, the Customer must promptly notify ProSoft by fax, email or telephone. In no event may that notification be received by ProSoft later than 15 months (or in the case of RadioLinx modules, 39 months) from the date of delivery. Within a reasonable time after notification, ProSoft will correct any failure of the Product to conform to specifications or any defect in material or workmanship of the Product, with either new or used replacement parts. Such repair, including both parts and labor, will be performed at ProSoft's expense. All warranty service will be performed at service centers designated by ProSoft. If ProSoft is unable to repair the Product to conform to this Warranty after a reasonable number of attempts, ProSoft will provide, at its option, one of the following: a replacement product, a full refund of the purchase price or a credit in the amount of the purchase price. All replaced product and parts become the property of ProSoft. These remedies are the Customer's only remedies for breach of warranty.

- B** *Warranty On Services:* Material and labor used by ProSoft to repair a verified malfunction or defect are warranted on the terms specified above for new Product, provided said warranty will be for the period remaining on the original new equipment warranty or, if the original warranty is no longer in effect, for a period of 90 days from the date of repair.
- C** The Warranty Period for RadioLinx accessories (such as antennas, cables, brackets, etc.) are the same as for RadioLinx modules, that is, three years from the date of shipment.

6.5.2 What Is Not Covered By This Warranty

- A** ProSoft makes no representation or warranty, expressed or implied, that the operation of software purchased from ProSoft will be uninterrupted or error free or that the functions contained in the software will meet or satisfy the purchaser's intended use or requirements; the Customer assumes complete responsibility for decisions made or actions taken based on information obtained using ProSoft software.
- B** With the exception of RadioLinx accessories referenced in paragraph 1(c) this Warranty does not cover any product, components, or parts not manufactured by ProSoft.
- C** This Warranty also does not cover the failure of the Product to perform specified functions, or any other non-conformance, defects, losses or damages caused by or attributable to any of the following: (i) shipping; (ii) improper installation or other failure of Customer to adhere to ProSoft's specifications or instructions; (iii) unauthorized repair or maintenance; (iv) attachments, equipment, options, parts, software, or user-created programming (including, but not limited to, programs developed with any IEC 61131-3 programming languages, or "C") not furnished by ProSoft; (v) use of the Product for purposes other than those for which it was designed; (vi) any other abuse, misapplication, neglect or misuse by the Customer; (vii) accident, improper testing or causes external to the Product such as, but not limited to, exposure to extremes of temperature or humidity, power failure or power surges outside of the limits indicated on the product specifications; or (viii) disasters such as fire, flood, earthquake, wind or lightning.
- D** The information in this Agreement is subject to change without notice. ProSoft shall not be liable for technical or editorial errors or omissions made herein; nor for incidental or consequential damages resulting from the furnishing, performance or use of this material. The user guides included with your original product purchased by you from ProSoft, contains information protected by copyright. No part of the guide may be duplicated or reproduced in any form without prior written consent from ProSoft.

6.5.3 *DISCLAIMER REGARDING HIGH RISK ACTIVITIES*

PRODUCT MANUFACTURED OR SUPPLIED BY PROSOFT IS NOT FAULT TOLERANT AND IS NOT DESIGNED, MANUFACTURED OR INTENDED FOR USE IN HAZARDOUS ENVIRONMENTS REQUIRING FAIL-SAFE PERFORMANCE (INCLUDING, WITHOUT LIMITATION, THE OPERATION OF NUCLEAR FACILITIES, AIRCRAFT NAVIGATION OF COMMUNICATION SYSTEMS, AIR TRAFFIC CONTROL, DIRECT LIFE SUPPORT MACHINES OR WEAPONS SYSTEMS), IN WHICH THE FAILURE OF THE PRODUCT COULD LEAD DIRECTLY OR INDIRECTLY TO DEATH, PERSONAL INJURY, OR SEVERE PHYSICAL OR ENVIRONMENTAL DAMAGE (COLLECTIVELY, "HIGH RISK ACTIVITIES"). PROSOFT SPECIFICALLY DISCLAIMS ANY EXPRESS OR IMPLIED WARRANTY OF FITNESS FOR HIGH RISK ACTIVITIES.

6.5.4 *DISCLAIMER OF ALL OTHER WARRANTIES*

THE WARRANTIES SET FORTH IN PARAGRAPH 1 ABOVE ARE IN LIEU OF ALL OTHER WARRANTIES, EXPRESS OR IMPLIED, INCLUDING BUT NOT LIMITED TO THE IMPLIED WARRANTIES OF MERCHANTABILITY AND FITNESS FOR A PARTICULAR PURPOSE.

6.5.5 *LIMITATION OF REMEDIES***

IN NO EVENT WILL PROSOFT (OR ITS DEALER) BE LIABLE FOR ANY SPECIAL, INCIDENTAL, OR CONSEQUENTIAL DAMAGES BASED ON BREACH OF WARRANTY, BREACH OF CONTRACT, NEGLIGENCE, STRICT TORT, OR ANY OTHER LEGAL THEORY. DAMAGES THAT PROSOFT AND ITS DEALER WILL NOT BE RESPONSIBLE FOR INCLUDE, BUT ARE NOT LIMITED TO: LOSS OF PROFITS; LOSS OF SAVINGS OR REVENUE; LOSS OF USE OF THE PRODUCT OR ANY ASSOCIATED EQUIPMENT; LOSS OF DATA; COST OF CAPITAL; COST OF ANY SUBSTITUTE EQUIPMENT, FACILITIES, OR SERVICES; DOWNTIME; THE CLAIMS OF THIRD PARTIES, INCLUDING CUSTOMERS OF THE PURCHASER; AND INJURY TO PROPERTY.

** Some areas do not allow time limitations on an implied warranty, or allow the exclusion or limitation of incidental or consequential damages. In such areas the above limitations may not apply. This Warranty gives you specific legal rights, and you may also have other rights which vary from place to place.

6.5.6 *Time Limit for Bringing Suit*

Any action for breach of warranty must be commenced within 15 months (or in the case of RadioLinx modules, 39 months) following shipment of the Product.

6.5.7 No Other Warranties

Unless modified in writing and signed by both parties, this Warranty is understood to be the complete and exclusive agreement between the parties, suspending all oral or written prior agreements and all other communications between the parties relating to the subject matter of this Warranty, including statements made by salesperson. No employee of ProSoft or any other party is authorized to make any warranty in addition to those made in this Warranty. The Customer is warned, therefore, to check this Warranty carefully to see that it correctly reflects those terms that are important to the Customer.

6.5.8 Intellectual Property

- A** Any documentation included with Product purchased from ProSoft is protected by copyright and may not be photocopied or reproduced in any form without prior written consent from ProSoft.
- B** ProSoft's technical specifications and documentation that are included with the Product are subject to editing and modification without notice.
- C** Transfer of title shall not operate to convey to Customer any right to make, or have made, any Product supplied by ProSoft.
- D** Customer is granted no right or license to use any software or other intellectual property in any manner or for any purpose not expressly permitted by any license agreement accompanying such software or other intellectual property.
- E** Customer agrees that it shall not, and shall not authorize others to, copy software provided by ProSoft (except as expressly permitted in any license agreement accompanying such software); transfer software to a third party separately from the Product; modify, alter, translate, decode, decompile, disassemble, reverse-engineer or otherwise attempt to derive the source code of the software or create derivative works based on the software; export the software or underlying technology in contravention of applicable US and international export laws and regulations; or use the software other than as authorized in connection with use of Product.

6.5.9 Additional Restrictions Relating To Software And Other Intellectual Property

In addition to complying with the Terms of this Warranty, Customers purchasing software or other intellectual property shall comply with any license agreement accompanying such software or other intellectual property. Failure to do so may void this Warranty with respect to such software and/or other intellectual property.

6.5.10 Allocation of risks

This Warranty allocates the risk of product failure between ProSoft and the Customer. This allocation is recognized by both parties and is reflected in the price of the goods. The Customer acknowledges that it has read this Warranty, understands it, and is bound by its Terms.

6.5.11 Controlling Law and Severability

This Warranty shall be governed by and construed in accordance with the laws of the United States and the domestic laws of the State of California, without reference to its conflicts of law provisions. If for any reason a court of competent jurisdiction finds any provisions of this Warranty, or a portion thereof, to be unenforceable, that provision shall be enforced to the maximum extent permissible and the remainder of this Warranty shall remain in full force and effect. Any cause of action with respect to the Product or Services must be instituted in a court of competent jurisdiction in the State of California.

Index**A**

Adding a Module • 31
 Adding a Project • 31
 Additional Restrictions Relating To Software And Other
 Intellectual Property • 72
 All Product Returns • 67
 Allocation of risks • 72

B

Backplane Data Transfer • 50
 Backplane Variables (KOS150Backplane) • 29
 Battery Life Advisory • 3

C

Cable Connections • 59
 Clearing a Fault Condition • 45
 Comment Entries • 33
 Configuring RSLinx • 17
 Connect your PC to the Module • 19
 Connect your PC to the Processor • 14
 Controlling Law and Severability • 73

D

Data Flow • 57
 Data Storage • 58
 DB9 to RJ45 Adaptor (Cable 14) • 63
 Diagnostics and Troubleshooting • 7, 39
 Disabling the RSLinx Driver for the Com Port on the
 PC • 61
 DISCLAIMER OF ALL OTHER WARRANTIES • 71
 DISCLAIMER REGARDING HIGH RISK ACTIVITIES •
 71
 Download the Project to the Module • 35
 Download the Sample Program to the Processor • 18

E

Exiting the Program • 44

F

Features and Benefits • 47
 Functional Overview • 7, 49
 Functional Specifications • 48

G

General Concepts • 49
 General Specifications • 47
 Guide to the MVI56-KOS150 User Manual • 7

H

Hardware Specifications • 48

Helper Objects • 29
 How to Contact Us
 Sales and Support • 66

I

Install ProSoft Configuration Builder Software • 10
 Install the Module in the Rack • 12
 Installing and Configuring the Module • 21
 Intellectual Property • 72

K

Keystrokes • 42

L

Ladder Logic • 37
 LED Status Indicators • 7, 45
 LIMITATION OF REMEDIES** • 71
 LIMITED WARRANTY • 69

M

Main Data Object (KOS150Module) • 26
 Main Logic Loop • 49
 Main Menu • 42
 Module Configuration • 21
 Module Data • 26
 Module Entries • 33
 Module Power Up • 49
 MVI56-KOS150 Configuration Data • 34

N

Navigation • 41
 No Other Warranties • 72
 Normal Data Transfer • 51

O

Open the Sample Ladder Logic • 15

P

Package Contents • 10
 Please Read This Notice • 2
 Printing a Configuration File • 33
 Procedures for Return of Units Out of Warranty • 68
 Procedures for Return of Units Under Warranty • 67
 Product Specifications • 7, 47
 ProSoft Configuration Builder • 29
 ProSoft® Product Documentation • 3
 Purchasing Warranty Extension • 69

R

Read Block • 51
 Reading Status Data from the Module • 39
 Reference • 7, 47
 Required Hardware • 39
 Return Material Authorization (RMA) Policies and
 Conditions • 66
 RS-232 • 59
 Modem Connection • 60

- Null Modem Connection (Hardware Handshaking)
• 60
- Null Modem Connection (No Hardware
Handshaking) • 61
- RS-232 Configuration/Debug Port • 61

S

- Select the Slot Number for the Module • 16
- Set Module Parameters • 32
- Set Up the Project • 30
- Setting Jumpers • 12
- Start Here • 7, 9
- Status Object (KOS150InStat) • 27
- Support, Service & Warranty • 7, 65
- System Requirements • 9

T

- The Configuration/Debug Menu • 40
- Time Limit for Bringing Suit • 71
- To Determine the Firmware Version of your Processor
• 15
- Transferring the Configuration File from MVI56 module
to PC • 43
- Transferring the Configuration File from PC to MVI56
module • 43
- Troubleshooting • 46

U

- Un-repairable Units • 68
- Using the Diagnostic Window in ProSoft Configuration
Builder • 40

V

- Viewing Block Transfer Statistics • 42
- Viewing Module Configuration • 43
- Viewing Port 0 Configuration • 44
- Viewing Port 0 Status • 44
- Viewing Version Information • 43

W

- Warnings • 2
- What Is Covered By This Warranty • 69
- What Is Not Covered By This Warranty • 70
- Write Block • 55

Y

- Your Feedback Please • 4