



Where Automation Connects.



## **ILX69-PBS**

**CompactLogix or MicroLogix Platform**  
PROFIBUS Slave Communication  
Module

October 12, 2016

**USER MANUAL**

## Your Feedback Please

We always want you to feel that you made the right decision to use our products. If you have suggestions, comments, compliments or complaints about our products, documentation, or support, please write or call us.

### **ProSoft Technology, Inc.**

9201 Camino Media, Suite 200

Bakersfield, CA 93311

+1 (661) 716-5100

+1 (661) 716-5101 (Fax)

[www.prosoft-technology.com](http://www.prosoft-technology.com)

support@prosoft-technology.com

© 2016 ProSoft Technology, Inc. All rights reserved.

ILX69-PBS User Manual

October 12, 2016

ProSoft Technology® is a registered copyright of ProSoft Technology, Inc. All other brand or product names are or may be trademarks of, and are used to identify products and services of, their respective owners.

## ProSoft Technology® Product Documentation

In an effort to conserve paper, ProSoft Technology no longer includes printed manuals with our product shipments. User Manuals, Datasheets, Sample Ladder Files, and Configuration Files are provided at:

[www.prosoft-technology.com](http://www.prosoft-technology.com)

## Important Safety Information

THIS EQUIPMENT IS AN OPEN-TYPE DEVICE AND IS MEANT TO BE INSTALLED IN AN ENCLOSURE SUITABLE FOR THE ENVIRONMENT SUCH THAT THE EQUIPMENT IS ONLY ACCESSIBLE WITH THE USE OF A TOOL.

SUITABLE FOR USE IN CLASS I, DIVISION 2, GROUPS A, B, C AND D HAZARDOUS LOCATIONS, OR NONHAZARDOUS LOCATIONS ONLY.

WARNING - EXPLOSION HAZARD - DO NOT DISCONNECT EQUIPMENT WHILE THE CIRCUIT IS LIVE OR UNLESS THE AREA IS KNOWN TO BE FREE OF IGNITABLE CONCENTRATIONS.

WARNING - EXPLOSION HAZARD - SUBSTITUTION OF COMPONENT MAY IMPAIR SUITABILITY FOR CLASS I, DIVISION 2.

DEVICES SHALL BE USED WITH ALLEN BRADLEY 1769 BACKPLANES

INPUT TO THE DEVICES SHALL BE FUSED AT 5A MAXIMUM.

# Contents

Your Feedback Please.....	2
ProSoft Technology® Product Documentation.....	2
Important Safety Information.....	2
<b>1 Introduction</b>	<b>7</b>
1.1 About the User Manual.....	7
1.1.1 Intended Audience .....	7
1.2 General Information ILX69-PBS.....	7
1.3 Reference Systems .....	8
1.4 1769 Programmable Controller Functionality.....	8
1.5 Requirements .....	9
1.5.1 Software Requirements.....	9
1.5.2 Hardware Requirements .....	9
<b>2 Safety</b>	<b>11</b>
2.1 General Note .....	11
2.2 Personnel Qualification .....	11
2.3 Safety Instructions to Avoid Personal Injury.....	11
2.3.1 Electrical Shock Hazard .....	12
2.3.2 Communication Stop During Firmware Update .....	12
2.4 Safety Instructions to Avoid Property Damage .....	12
2.4.1 Device Destruction if ILX69-PBS is Installed to Powered PLC .....	13
2.4.2 Device Destruction by Exceeding Allowed Supply Voltage .....	13
2.4.3 Device Destruction by Exceeding Allowed Signaling Voltage.....	13
2.4.4 Electrostatically sensitive devices .....	13
2.5 Labeling of Safety Messages .....	14
2.6 Safety References.....	15
<b>3 About the ILX69-PBS</b>	<b>17</b>
3.1 Device Drawing ILX69-PBS .....	17
3.2 PROFIBUS Interface .....	18
3.2.1 Wiring Instructions.....	18
3.3 Ethernet Interface.....	20
3.3.1 Ethernet Pin Assignment at the RJ45 Socket .....	20
3.3.2 Ethernet Connection Data .....	21
3.4 Removable Memory Card .....	21
3.5 Power Supply .....	21
<b>4 Installation</b>	<b>23</b>
4.1 Consideration when planning the system .....	23
4.2 ILX69-PBS Hardware Installation.....	24
4.2.1 Safety Precautions .....	24
4.2.2 Installing the ILX69-PBS Module .....	24
4.3 Uninstalling ILX69-PBS Hardware .....	25

<b>5</b>	<b>Configuration and Start-Up</b>	<b>27</b>
5.1	Creating the Module in an RSLogix 5000 Project.....	27
5.1.1	Creating a Module in the Project Using an Add-On Profile .....	28
5.1.2	Manually Creating a Module in the Project.....	35
5.1.3	Importing the Ladder Rung .....	39
5.2	Slave Configuration .....	45
5.2.1	GSD File .....	45
5.2.2	Configuration by Master.....	45
5.2.3	Configuration by Controller Application .....	46
5.2.4	Configuration Parameters.....	47
5.3	SD Card .....	49
5.3.1	Start-up Behavior with or without SD Card.....	49
5.3.2	STARTUP.INI File.....	50
5.3.3	Reset Device to Factory Settings with Memory Card .....	50
<b>6</b>	<b>Communication</b>	<b>51</b>
6.1	Studio 5000 PROFIBUS Data Values .....	51
6.1.1	PROFIBUS Network Input Data.....	51
6.1.2	PROFIBUS Network Output Data.....	52
6.2	I/O Communication and Memory Map.....	52
6.2.1	I/O Arrays Overview.....	52
6.2.2	Input Array .....	53
6.2.3	Output Array.....	59
6.3	Acyclic Messaging .....	60
6.3.1	Supported PROFIBUS DP Messages .....	60
6.3.2	Standard Messaging.....	61
6.3.3	DPV1 Messaging .....	64
6.3.4	CIP Messaging Error Codes.....	68
<b>7</b>	<b>Diagnostics and Troubleshooting</b>	<b>71</b>
7.1	Web Page .....	71
7.1.1	General Device and Diagnostics Information .....	72
7.1.2	Firmware Update .....	76
7.2	Hardware LEDs.....	84
7.2.1	CompactLogix LEDs .....	84
7.2.2	ILX69-PBS LEDs .....	85
7.3	Troubleshooting .....	87
<b>8</b>	<b>Technical Data</b>	<b>89</b>
8.1	Technical Data - ILX69-PBS.....	89
8.2	Technical Data - PROFIBUS .....	92
<b>9</b>	<b>Annex</b>	<b>93</b>
9.1	PROFIBUS Functionality .....	93
9.1.1	DPV0 Services.....	93
9.1.2	DPV1 Services.....	94
9.2	Disposal of Electronic Equipment Waste.....	95

---

9.3	References .....	95
9.4	Glossary .....	96
<b>10</b>	<b>Support, Service &amp; Warranty</b>	<b>99</b>

---

10.1	Contacting Technical Support .....	99
10.2	Warranty Information .....	100

---

<b>Index</b>		<b>101</b>
--------------	--	------------

---



# 1 Introduction

## *In This Chapter*

❖ About the User Manual .....	7
❖ General Information ILX69-PBS .....	7
❖ Reference Systems.....	8
❖ 1769 Programmable Controller Functionality .....	8
❖ Requirements .....	9

## 1.1 About the User Manual

This user manual provides descriptions and detailed information about:

- How to assemble the ILX69-PBS into a CompactLogix™ system.
- PROFIBUS wiring
- Configuration and start-up
- Communication
- Diagnostics
- LED displays
- Technical data and electrical/environmental specifications

### 1.1.1 Intended Audience

The intended audiences for this manual are the individuals responsible for designing, installing, programming, or troubleshooting control systems that use the Rockwell CompactLogix™ 1769 programmable controller and the ILX69-PBS. You should have a basic understanding of electrical circuitry and familiarity with relay logic. If you do not, obtain the proper training before using this product.

## 1.2 General Information ILX69-PBS

The ILX69-PBS is a slot extension module for Rockwell's CompactLogix™ 1769 system which allows the PLC to exchange data on a PROFIBUS network.

The ILX69-PBS PROFIBUS DPV1 slave exchanges data with the connected PROFIBUS DP master.

The configuration is stored permanently in the on-board FLASH memory of the ILX69-PBS and is available immediately on power up. The data exchange between controller and module is done via the I/O process data image using CompactLogix™ backplane technology.

The diagnostics of the ILX69-PBS can be done using the CompactLogix™ PLC program, via the ProSoft web pages or by help of the master configuration and diagnostics software.

### 1.3 Reference Systems

The firmware of the ILX69-PBS was developed and tested with the following CompactLogix™ controller types and firmware revisions.

#### CompactLogix System

Controller	Firmware
CompactLogix™ 1769-L23	V17.05
CompactLogix™ 1769-L32E	V20.13
CompactLogix™ 1769-L36ERM	V21.11

### 1.4 1769 Programmable Controller Functionality

PROFIBUS DP supports acyclic services through messages. These PROFIBUS DP services are supported by the Studio 5000 programming tool using CIP messages. Not all of the 1769 programmable controllers support CIP messaging.

The basic PROFIBUS DP acyclic services Global Control or slave Diagnostics request are also executable in addition to the CIP method by using the I/O area. The following table displays the 1769 programmable controllers and the functionalities they support.

#### CompactLogix System

Processor	I/O (cyclic)	CIP Messaging (acyclic)
CompactLogix™ 5370 L2x and L3x	Yes	Yes
CompactLogix™ 1769-L23	Yes	Yes
CompactLogix™ 1769-L24x *	Yes	Yes
CompactLogix™ 1769-L30	Yes	No
CompactLogix™ 1769-L31	Yes	Yes
CompactLogix™ 1769-L32E	Yes	Yes
CompactLogix™ 1769-L33ER	Yes	Yes
CompactLogix™ 1769-L35E	Yes	Yes
CompactLogix™ 1769-L36ERM	Yes	Yes

(\*) Only one ILX69-PBS is supported on the bus due to power restrictions.

Yes = Functionality supported

No = Functionality not supported



## 1.5 Requirements

### 1.5.1 Software Requirements

The software requirements for using the ILX69-PBS within a CompactLogix™ system are listed below. You must have the following software installed on your PC unless otherwise noted:

#### CompactLogix System

- Studio 5000 programming software, V21.00 or higher
- RSLogix™ 5000 programming software, V20.00 or higher

### 1.5.2 Hardware Requirements

The following minimum hardware is required to use the ILX69-PBS:

- Windows PC with SD card slot or SD card reader
- Ethernet cable for ILX69-PBS web page connection

#### CompactLogix System

- Personal Computer
- 1769 – Programmable controller (1769-L23, 1769-L32E and 1769-L36ERM)
- 1769 – Power supply
- 1769 – Right or left handed termination end cap
- Ethernet cable for interface to the 1769 programmable controller



## 2 Safety

### *In This Chapter*

❖ General Note .....	11
❖ Personnel Qualification .....	11
❖ Safety Instructions to Avoid Personal Injury.....	11
❖ Safety Instructions to Avoid Property Damage .....	12
❖ Labeling of Safety Messages .....	14
❖ Safety References .....	15

### 2.1 General Note

The documentation in the form of a user manual, an operating instruction manual or other manual types, as well as the accompanying texts have been created for the use of the products by educated personnel. When using the products, all Safety Messages, Integrated Safety Messages, Property Damage Messages and all valid legal regulations must be obeyed. Technical knowledge is presumed. The user must assure that all legal regulations are obeyed.

### 2.2 Personnel Qualification

The ILX69-PBS must only be installed, configured, and removed by qualified personnel. Job-specific technical skills for people professionally working with electricity must be present concerning the following topics:

- Safety and health at work
- Mounting and connecting of electrical equipment
- Measurement and analysis of electrical functions and systems
- Evaluation of the safety of electrical systems and equipment
- Installing and configuring IT systems

### 2.3 Safety Instructions to Avoid Personal Injury

To ensure your own personal safety and to avoid personal injury, you necessarily must read, understand and follow the safety instructions and safety messages in this manual before you install and operate the ILX69-PBS.

### **2.3.1 Electrical Shock Hazard**

The danger of a lethal electrical shock caused by parts with more than 50V may occur if you power a PLC power supply module when its housing is open.

- HAZARDOUS VOLTAGE is present inside of a powered PLC power supply module.
- Strictly obey all safety rules provided by the device manufacturer in the documentation.
- Disconnect the network power (power plug) from the power supply module before you disconnect the PLC module from the backplane.
- When you disconnect the PLC module from the power supply module, use end cap terminators and close the power supply module housing.

An electrical shock is the result of a current flowing through the human body. The resulting effect depends on the intensity and duration of the current and on its path through the body. Currents in the range of approximately ½ mA can cause effects in persons with good health, and indirectly cause injuries resulting from startling responses. Higher currents can cause more direct effects, such as burns, muscle spasms, or ventricular fibrillation.

In dry conditions, permanent voltages up to approximately 42.4 V peak or 60 V are not considered as dangerous if the contact area is equivalent to the size of a human hand.

More information is located at Safety References (page 15).

### **2.3.2 Communication Stop During Firmware Update**

If you plan a firmware update via the ProSoft web pages, please yield:

- During the firmware update procedure, a device reset is performed and stops all module communication functions with network devices. An unintended plant stop can cause personal injury.
- Initiating a device reset causes a device reboot. A reboot stops all communication immediately.
- Personal injury by consequence of careless use caused plant stop can not be excluded.
- All fieldbus devices should be placed in a fail-safe condition under direct supervision before starting a firmware update.
- Before you initiate a reset, make sure your system is in an idle state and operating under maintenance conditions in order to prevent personal injury.
- Stop the PLC program before you start the firmware update.

More firmware update information is located at Firmware Update.

## **2.4 Safety Instructions to Avoid Property Damage**

To avoid system damage and device destruction to the ILX69-PBS, you necessarily must read, understand and follow the following safety instructions and safety messages in this manual before you install and operate the ILX69-PBS.

### **2.4.1 Device Destruction if ILX69-PBS is Installed to Powered PLC**

To avoid device destruction when the ILX69-PBS is powered up:

- Strictly obey to all safety rules provided by the PLC device manufacturer documentation.
- Shut off the power supply of the PLC, before you install the ILX69-PBS module.

### **2.4.2 Device Destruction by Exceeding Allowed Supply Voltage**

To avoid device destruction due to high supply voltage to the ILX69-PBS, you must observe the following instructions.

- The ILX69-PBS may only be operated with the specified supply voltage. Make sure that the limits of the allowed range for the supply voltage are not exceeded.
- A supply voltage above the upper limit can cause severe damage to the ILX69-PBS.
- A supply voltage below the lower limit can cause malfunction in the ILX69-PBS.
- The allowed range for the supply voltage is defined by the tolerances specified in this manual.



Mandatory supply voltage information is located at Power Supply (page 21).

---

### **2.4.3 Device Destruction by Exceeding Allowed Signaling Voltage**

To avoid device destruction due to high signal voltage to the ILX69-PBS, you must observe the following instructions.

- All I/O signal pins at the ILX69-PBS tolerate only the specified signaling voltage.
- Operation of the ILX69-PBS with a signaling voltage other than the specified signaling voltage may lead to severe damage to the module.



Mandatory signaling voltage information is located at Power Supply (page 21).

---

### **2.4.4 Electrostatically sensitive devices**







This equipment is sensitive to electrostatic discharge, which can cause internal damage and affect normal operation. Therefore, adhere to the necessary safety precautions for components that are vulnerable with electrostatic discharge when handling the ILX69-PBS. Follow the guidelines listed when you handle this equipment:



- Touch a grounded object to discharge potential static.
- Wear an approved grounding wrist strap.
- Do not touch connectors or pins on the ILX69-PBS.
- Do not touch circuit components inside the equipment.
- If available, use a static-safe workstation.
- When not in use, store the equipment in appropriate static-safe packaging.

More information is located at Safety References (page 15).

## 2.5 Labeling of Safety Messages

- The **Safety Messages** at the beginning of a chapter are pinpointed particularly and highlighted by a signal word according to the degree of endangerment. The type of danger is specified by the safety message text and optionally by a specific safety sign.
- The **Integrated Safety Messages** within an instruction description are highlighted with a signal word according to the degree of endangerment. The type of danger is specified by the safety message text.

Signal Word	Meaning (International)		Meaning (USA)
	Indicates a direct hazard with high risk, which will have a consequence of death or grievous bodily harm if it is not avoided.		Indicates a hazardous situation which if not avoided, will result in death or serious injury.
	Indicates a possible hazard with medium risk, which will have a consequence of death or (grievous) bodily harm if it is not avoided.		Indicates a hazardous situation which if not avoided, could result in death or serious injury.
	Indicates a minor hazard with medium risk, which could have a consequence of simple battery if it is not avoided.		Indicates a hazardous situation which if not avoided, may result in minor or moderate Injury.
Safety Sign	USA	Warning or Principle	
		Warning of lethal electrical shock	
		Principle: Disconnect the power plug	

Signal Word	Meaning (International and USA)	
	Indicates a property damage message.	
Safety Sign	Warning or Principle	
	Warning on damages by electrostatic discharge	
-	Example: Warning of device destruction due to exceedingly high supply voltage	

In this document, all Safety Instructions and Safety Messages are designed according both to the international used safety conventions as well as to the ANSI Z535.6 standard, refer to Safety References (page 15).

In this document, the signal words 'WARNING', 'CAUTION' and 'NOTICE' are used according to ANSI Z535.6 standard. The meaning given in ISO/IEC 26514 [4] section '11.11 Contents of warnings and cautions is not relevant in this manual.

## 2.6 Safety References

- [S1] ANSI Z535.6-2006 American National Standard for Product Safety Information in Product Manuals, Instructions, and Other Collateral Materials
- [S2] IEC 60950-1, Information technology equipment - Safety - Part 1: General requirements, (IEC 60950-1:2005, modified); German Edition EN 60950-1:2006
- [S3] EN 61340-5-1 and EN 61340-5-2 as well as IEC 61340-5-1 and IEC 61340-5-2
- [S4] 26514-2010 - IEEE Standard for Adoption of ISO/IEC 26514:2008 Systems and Software Engineering--Requirements for Designers and Developers of User Documentation





### 3 About the ILX69-PBS

*In This Chapter*

- ❖ Device Drawing ILX69-PBS .....17
- ❖ PROFIBUS Interface.....18
- ❖ Ethernet Interface .....20
- ❖ Removable Memory Card .....21
- ❖ Power Supply.....21

#### 3.1 Device Drawing ILX69-PBS

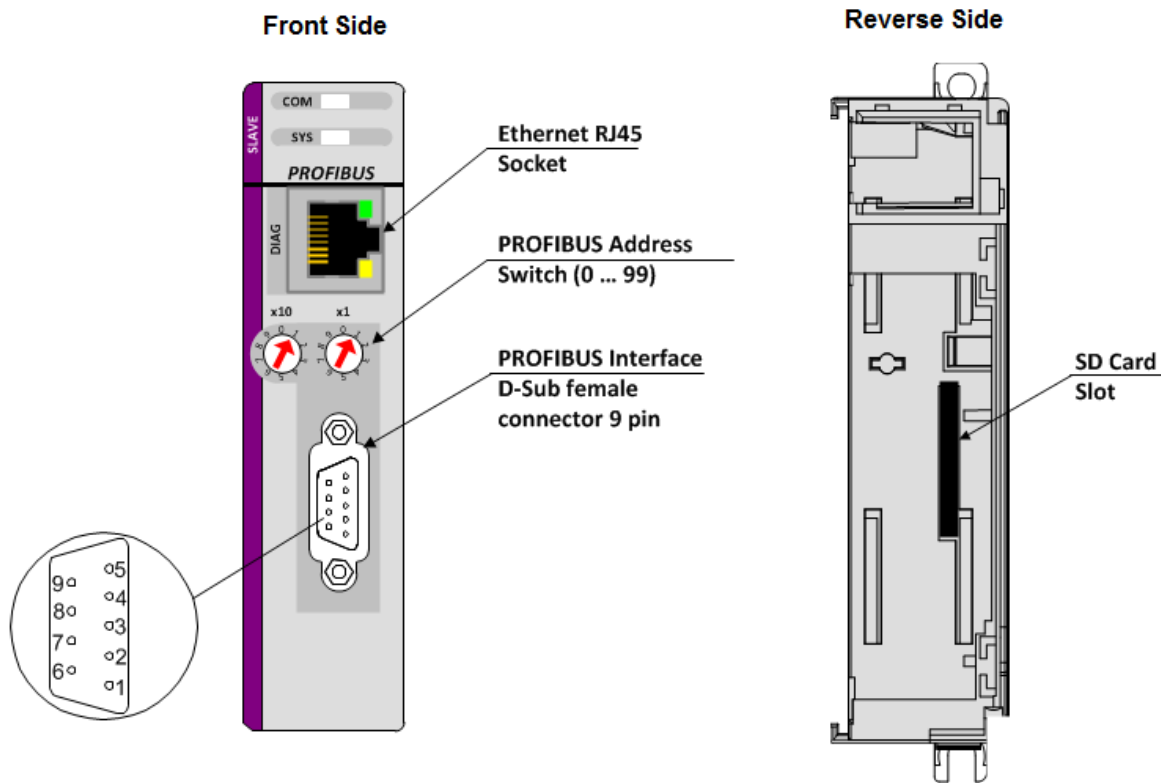

### 3.2 PROFIBUS Interface

PROFIBUS Interface (D-Sub female connector, 9 pin):

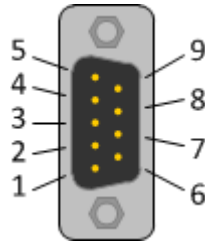

Connection with D-Sub female connector	Signal	Description
3	RxD / TxD-P	Receive/Send Data-P, respectively connection B plug
4	CNTR-P	Repeater-Control
5	DGND	Data Ground
6	VP	Positive supply voltage
8	RxD / TxD-N	Receive/Send Data-N, respectively connection A plug

#### 3.2.1 Wiring Instructions

Please ensure that termination resistors are available at both ends of the PROFIBUS network cable. If special PROFIBUS connectors are being used, these resistors are often found inside the connector and must be switched on at each end of the PROFIBUS network cable.

For baud rates above 1.5 MBaud, use only special connectors for higher baud rates. These include additional inductance.

It is not permitted to have T-stubs on PROFIBUS high baud rates. Use only a special cable which is approved for PROFIBUS DP. Make a solid connection from the cable shield to ground at every device and make sure that there is no potential difference between the grounds at the devices.

If the ILX69-PBS is linked with only one other device on the bus, both devices must be connected to the ends of the bus line. These devices must deliver the supply voltage for the termination resistors. If three or more devices are connected to the bus, the ILX69-PBS can be connected at any desired position.

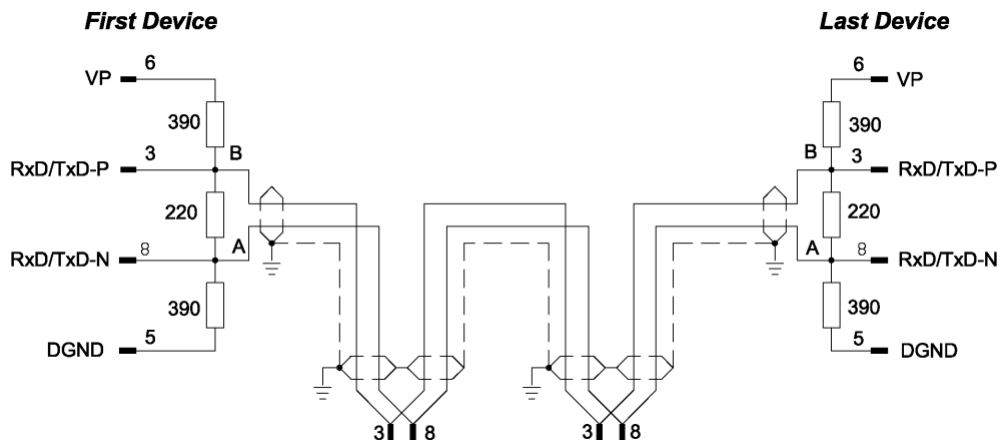

Up to 32 PROFIBUS devices can be connected to one bus segment, without repeaters. If several bus segments are linked to each other with repeaters, there can be up to 127 devices on the network.

The maximum permissible cable length of a PROFIBUS segment depends on the baud rate used, see the following table.

Baud rate in kBit/s	Maximum distance
9.6	1,200 meters 3,940 feet
19.2	1,200 m 3,940 ft
93.75	1,200 m 3,940 ft
187.5	1,000 m 3,280 ft
500	400 m 1,310 ft
1,500	200 m 656 ft
3,000	100 m 328 ft
6,000	100 m 328 ft
12,000	100 m 328 ft

Only PROFIBUS certified cables, preferably the cable type A, should be used. The following table contains important electrical data concerning PROFIBUS certified cable:

Parameter	Value
Impedance	35 to 165 Ohm at frequencies from 3 to 20 Mhz
Capacity per units length	< 30 pF/m
Loop resistance	110 Ohm/km
Wire gauge	0.64 mm

### 3.3 Ethernet Interface

The Ethernet cable should contain an RJ45 connector. It should have a twisted pair cable of category 5 (CAT5) or higher, which consists of 4 twisted cores and has a maximum transmission rate of 100 MBit/s (CAT5).

#### 3.3.1 Ethernet Pin Assignment at the RJ45 Socket



**Note:** The device supports the **Auto Crossover** function. The RX and TX can be switched. The following figure shows the RJ45 standard pin assignment.

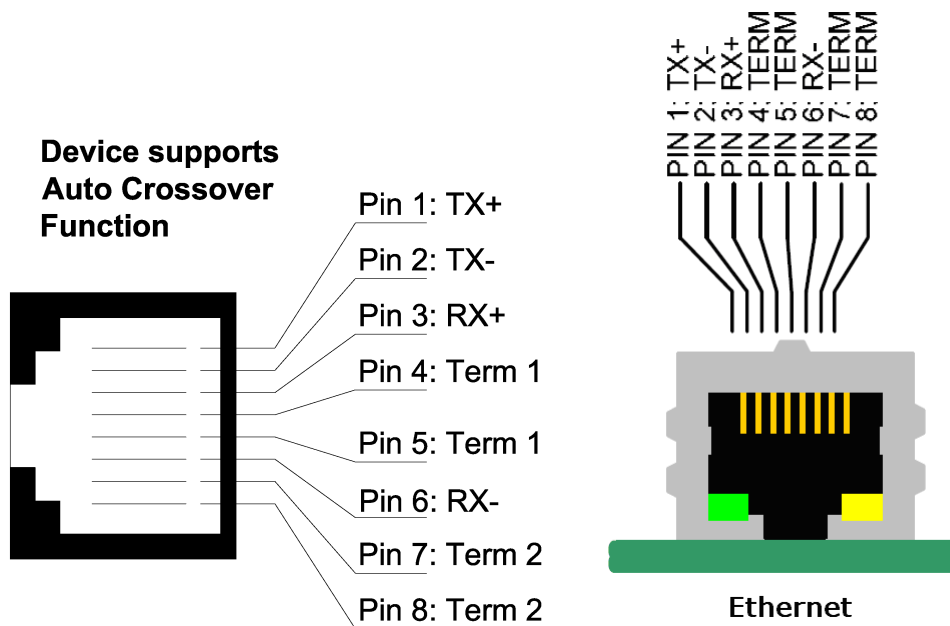

Pin	Signal	Description
1	TX+	Transmit Data +
2	TX-	Transmit Data -
3	RX+	Receive Data +
4	Term 1	Connected to each other and terminated to PE through RC circuit*
5	Term 1	
6	RX-	Receive Data -
7	Term 2	Connected to each other and terminated to PE through RC circuit*
8	Term 2	
		*Bob Smith Termination

### 3.3.2 Ethernet Connection Data

<b>Medium</b>	2 x 2 Twisted-pair copper cable, CAT5 (100 MBit/s) or better
<b>Length of cable</b>	Maximum 100 m
<b>Transmission rate</b>	10 MBit/s / 100 MBit/s

### 3.4 Removable Memory Card

#### Memory Card

<b>Type</b>	SD card (HDSC format is not supported)
<b>Maximum storage capacity</b>	4 GByte
<b>Required formatting</b>	FAT16 format (no FAT32)

#### SD Card Connector

SD Card Connector, e.g. FPS009-2405-0 push/push

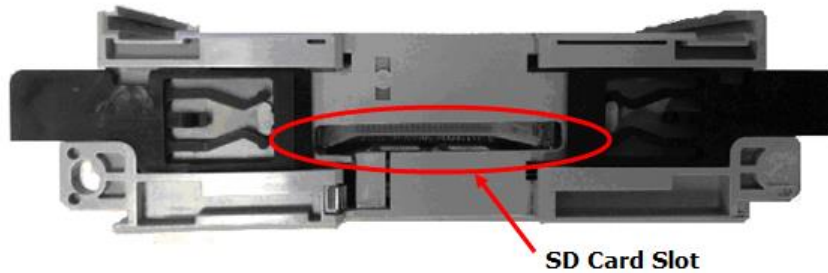

### 3.5 Power Supply

<b>Power supply</b>	5V from backplane
<b>Current Load CompactLogix</b>	570 mA Max. @ 5 VDC Power rating of 2
<b>Backplane power</b>	5 VDC: Min: 4.75 V at Module; Max: 5.40 V at Module 24 VDC: Min: 19.9 V at Module; Max: 26.4 V at Module



## 4 Installation

### In This Chapter

- ❖ Consideration when planning the system .....23
- ❖ ILX69-PBS Hardware Installation .....23
- ❖ Uninstalling ILX69-PBS Hardware .....25

### 4.1 Consideration when planning the system

#### Issues for the Network Conception

- The ILX69-PBS has address rotary switches to set an station address from 0 to 99. If set to 0, address will be taken from the configuration assembly. Using the PLCs configuration data, an address range from 0 to 125 is adjustable.
- The ILX69-PBS is capable of automatic baud rate detection.
- A 1769-ECR (right end cap) or 1769-ECL (left end cap) is required to terminate the end of the Compact I/O bus.
- Each bank of Compact I/O must have its own power supply.
- A Compact I/O power supply has limits on the amount of +5 VDC and +24 VDC current it can supply to modules in its I/O bank. These limits depend on the catalog number (e.g. 1769-PA2) of the supply. A bank of modules must not exceed the current limits of the I/O bank power supply. Refer to the Compact 1769 Expansion I/O Power Supplies Installation Instructions.
- The ILX69-PBS has a distance rating of 2. Therefore, the module must be within 2 slots of the I/O bank's power supply.

#### Configuration and Network Communication

- Determine the PROFIBUS baud rate based on standard PROFIBUS system considerations.
- Identify the number of words of I/O data each slave supports.

## 4.2 ILX69-PBS Hardware Installation

This section describes how to install/uninstall the ILX69-PBS into a CompactLogix™ system.

### 4.2.1 Safety Precautions

Obey the following property damage messages when installing, uninstalling or replacing the ILX69-PBS.

---

#### NOTICE

##### Electrostatically sensitive devices

- To prevent damage to the PLC and the ILX69-PBS, make sure that the ILX69-PBS is grounded via the backplane of the PLC. Also make sure that you are discharged when you install/uninstall the ILX69-PBS.

---

#### NOTICE

##### Device Destruction

- Shut off the power supply of the PLC before you install the ILX69-PBS. Then install or remove the ILX69-PBS to/from the PLC..
  - Use only the permissible supply voltage to operate the ILX69-PBS.
  - All I/O signal pins at the ILX69-PBS tolerate only the specified signaling voltage.
- 

### 4.2.2 Installing the ILX69-PBS Module



A detailed description the installation of communication modules in CompactLogix™ systems can be found in the installation manual for the 1769 CompactLogix™ controller from Rockwell Automation.

---

- 1 Install the ILX69-PBS into a free slot in the CompactLogix™ controller. Make sure it is within 2 slots of a power supply.
- 2 Check that the bus lever of the ILX69-PBS is in the unlocked (fully right) position.
- 3 Assemble the ILX69-PBS and the CompactLogix™ module together by using the upper and lower tongue-and-groove slots.
- 4 Move the ILX69-PBS back along the tongue-and-groove slots until the bus connectors line up with each other.
- 5 Move the ILX69-PBS bus lever fully to the left until it clicks. Ensure it is locked firmly in place.
- 6 Attach and lock an end cap terminator to the ILX69-PBS by using the tongue-and-groove slots as before.
- 7 Apply power to the Rockwell CompactLogix™ controller.



### 4.3 Uninstalling ILX69-PBS Hardware

- 1 Adhere to the safety precautions.
- 2 Shut off the power of the Rockwell CompactLogix™ controller.
- 3 Discharge yourself.
- 4 Unlock the end cap bus terminator.
- 5 Remove the end cap terminator from the ILX69-PBS by using the tongue-and-groove slots.
- 6 Move the ILX69-PBS bus lever in the unlocked (fully right) position.
- 7 Remove the ILX69-PBS along the tongue-and-groove slots.
- 8 Reassemble the end cap terminator and the CompactLogix™ system together by using the upper and lower tongue-and-groove slots.



## 5 Configuration and Start-Up

### In This Chapter

- ❖ Creating the Module in an RSLogix 5000 Project .....27
- ❖ Slave Configuration .....45
- ❖ SD Card .....49

This chapter provides descriptions about the configuration and start-up of the ILX69-PBS.

### **ILX69-PBS Configuration and Parameterization Steps:**

The configuration and parameterization of the ILX69-PBS is carried out in three steps:

- 1 Configuration of the module in a CompactLogix™ project of the Studio 5000 or RSLogix 5000 programming tool.
- 2 Parameterization and configuration of the ILX69-PBS using the master configuration software. The slave module can use this configuration during startup.
- 3 Creating the data objects and the ladder diagram in Studio 5000/RSLogix 5000.

### **5.1 Creating the Module in an RSLogix 5000 Project**

In an RSLogix 5000 project, there are two ways you can add the ILX69-PBS module to the project.

- You can use an Add-On Profile (AOP) from ProSoft Technology. The AOP contains all the configuration information needed to add the module to the project. This is the preferred way, but requires RSLogix version 15 or later.
- You can manually create the module using a generic 1769 profile, and then manually configure the module parameters. Use this method if you have RSLogix version 14 or earlier.

### 5.1.1 Creating a Module in the Project Using an Add-On Profile

#### Installing an Add-On Profile

Download the **MPSetup.exe** file from the product web page (found at [www.prosoft-technology.com](http://www.prosoft-technology.com)) onto the local hard drive. Make sure RSLogix 5000 and RSLinx have been shut down before installing the Add-On Profile (AOP).

- 1 Run the **MPSetup.exe** file to start the Setup Wizard. Follow the Setup Wizard to install the AOP. (The version may be different than shown below).

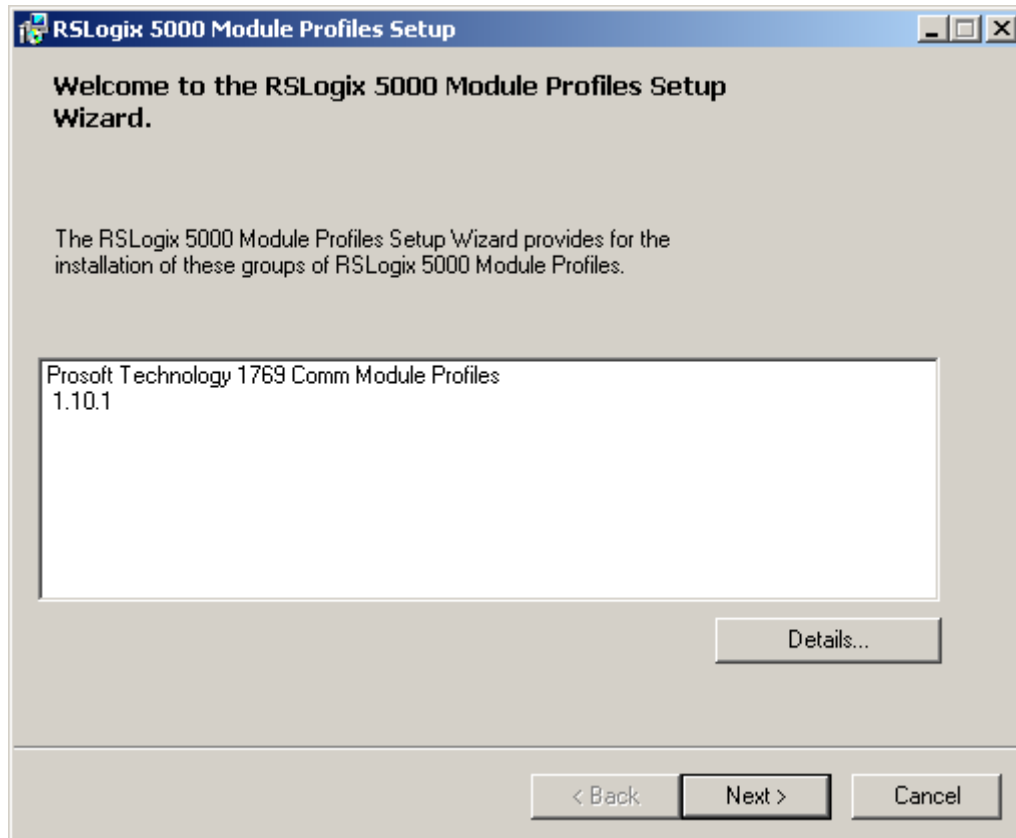

- 2 Continue to follow the steps in the wizard to complete the installation.

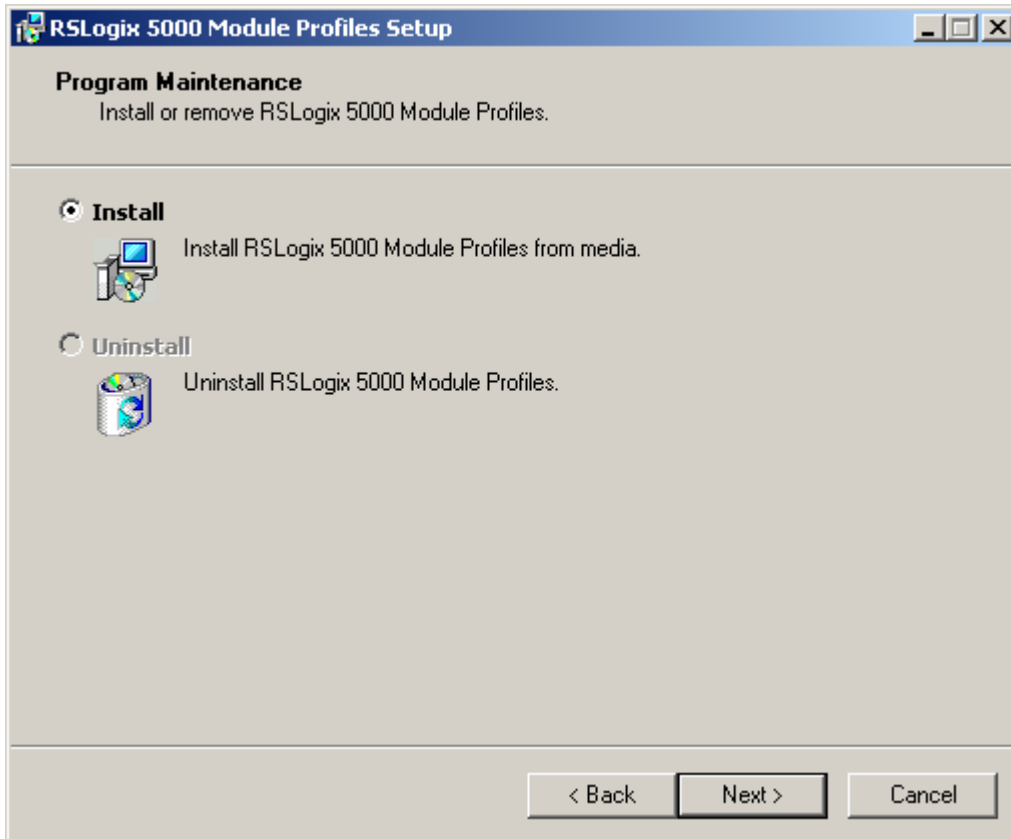

- 3 Click **FINISH** when complete. The AOP is now installed in RSLogix 5000. You do not need to reboot the PC.

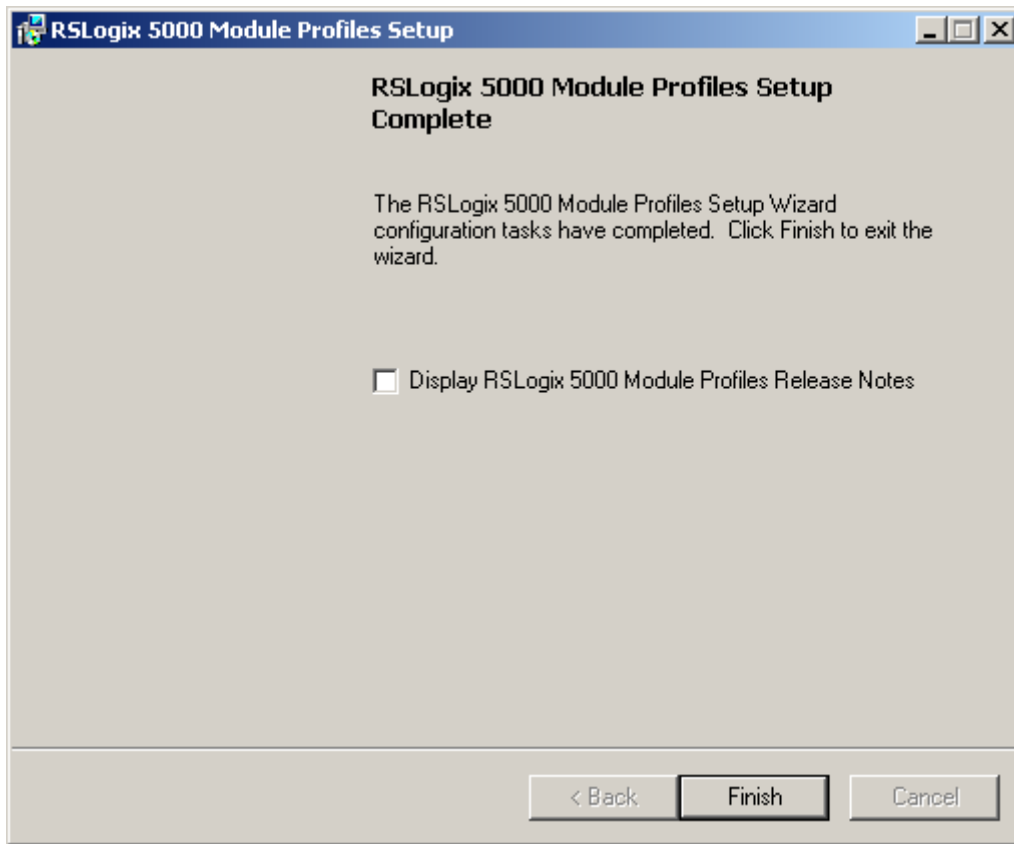

Using an Add-On Profile

- 1 In RSLogix 5000, expand the **I/O CONFIGURATION** folder in the Project tree. Right-click the appropriate communications bus and choose **NEW MODULE**.

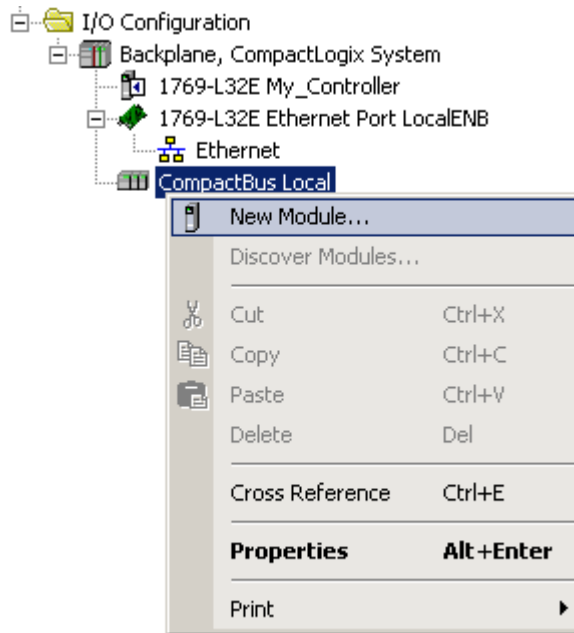

This opens the *Select Module Type* dialog box. In the *Module Type Vendor Filters* area, uncheck all boxes except the **PROSOFT TECHNOLOGY** box. A list of ProSoft Technology modules appears in the dialog box.

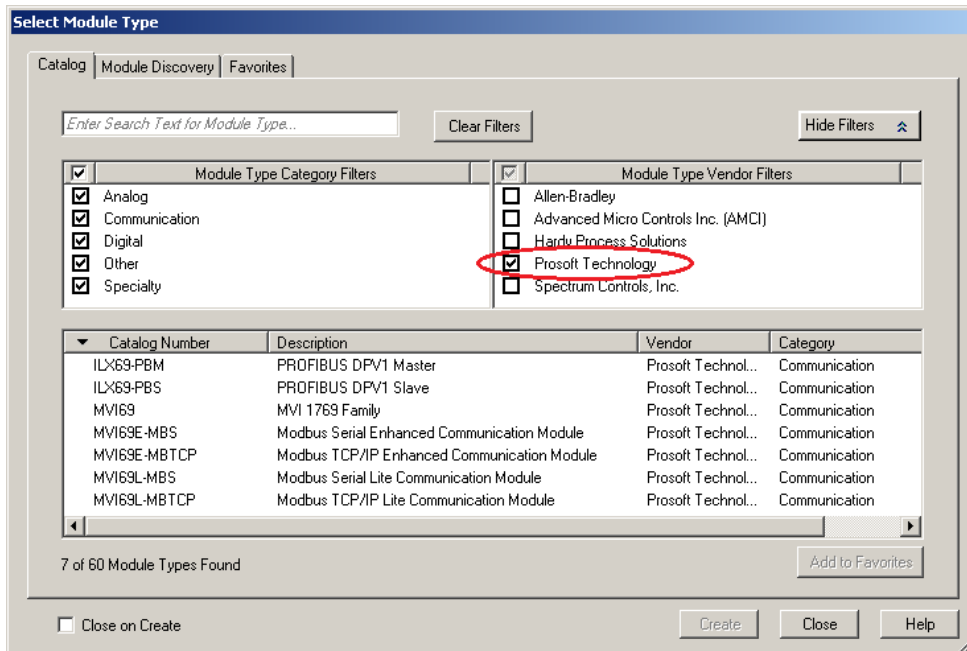

2 Select the **ILX69-PBS** module in the list and click **CREATE**:

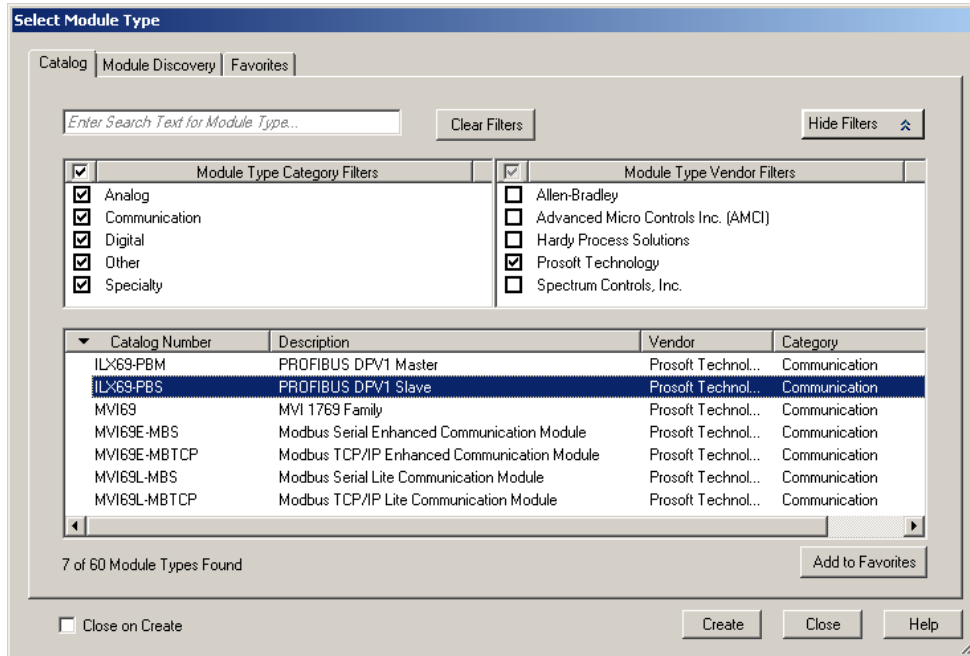



- 3 A *New Module* dialog box opens. In the **GENERAL** tab, enter "ILX69PBS" in the **NAME** field and the appropriate **SLOT** for the module.

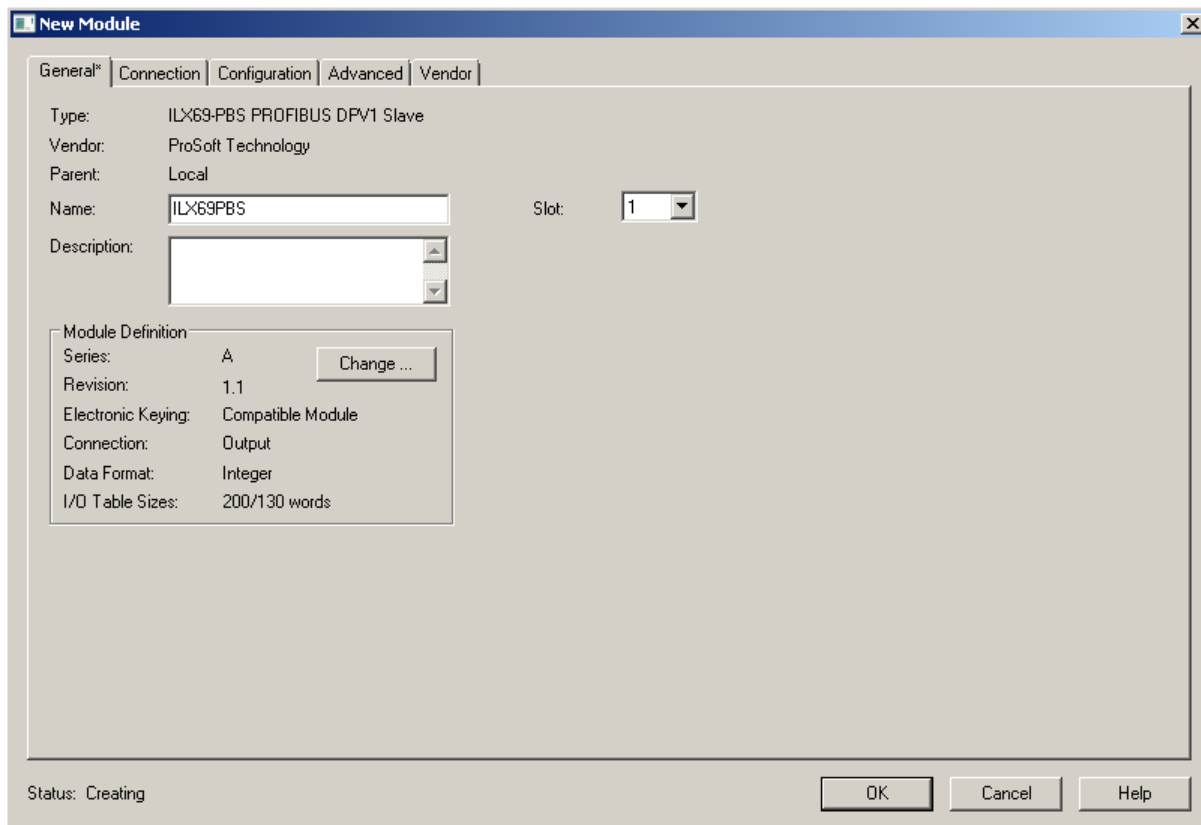

- 4 Click on the **CONFIGURATION** tab (Offline). This option assigns the IP Address, Subnet Mask, and Gateway Address of the module. If applicable, select **MANUALLY CONFIGURE IP SETTINGS** from the *IP Settings* field to manually enter your values.

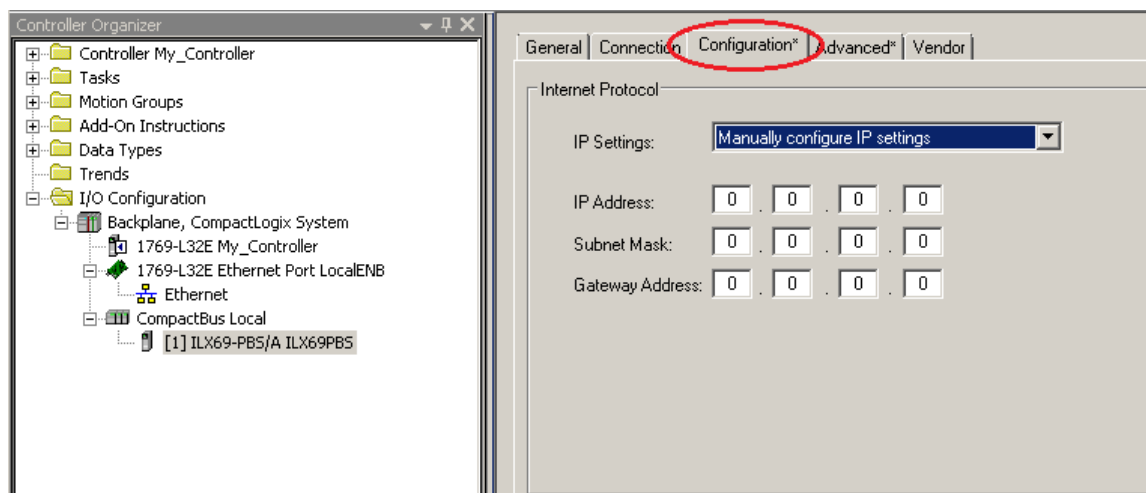

- 5 Click on the **ADVANCED** tab (Offline). This option assigns the **STATION ADDRESS** (PROFIBUS Slave ID) of the ILX69-PBS.

It also determines how the ILX69-PBS obtains its configuration by **CONFIGURATION TYPE**. In most applications, **OBTAIN FROM MASTER** is sufficient. With this option, the configuration is done within the PROFIBUS master software and sent to the ILX69-PBS.

The **OBTAIN FROM LADDER** option is a unique option that allows the CompactLogix controller to "lock" the ILX69-PBS PROFIBUS configuration. Once this option is selected, you will manually configure the PROFIBUS I/O data in the *Module Configuration* section of the tab. The PROFIBUS Master's configuration for this slave must match 100%, or communications will fail.

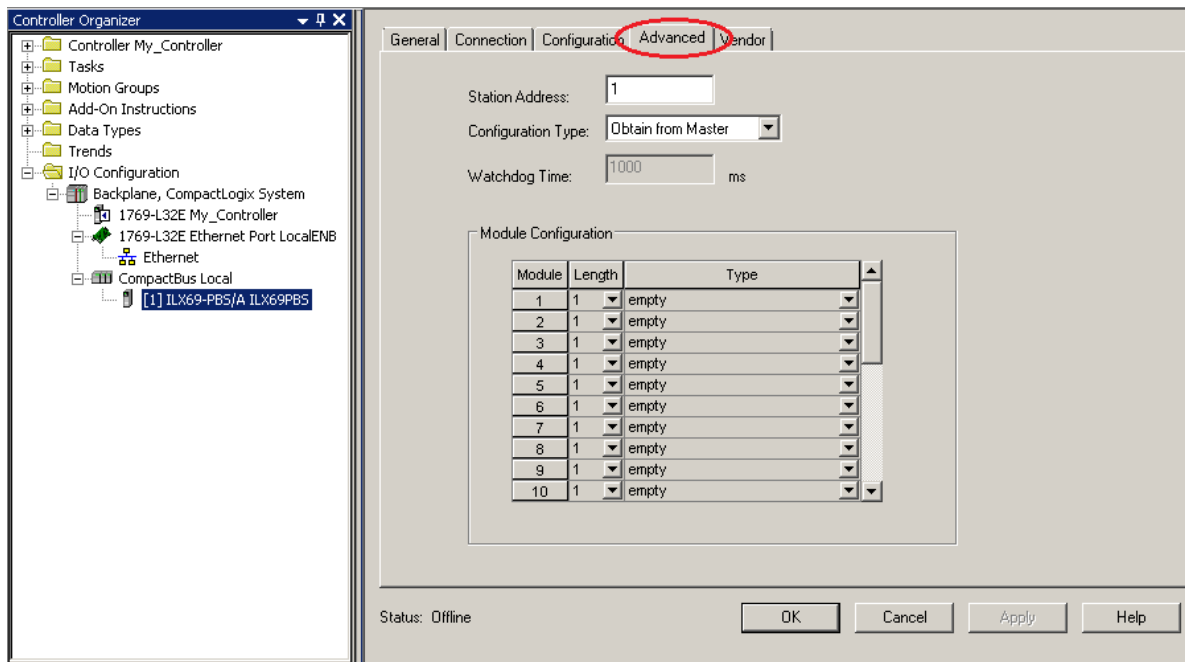

- 6 Click **OK**.
- 7 The ILX69-PBS module is now visible in the I/O Configuration tree.

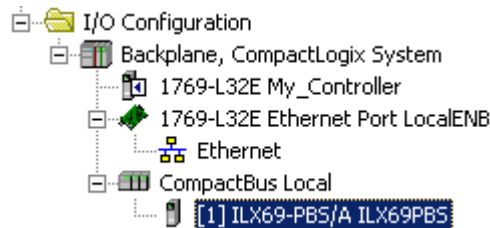

### 5.1.2 Manually Creating a Module in the Project

This section covers the manual configuration of the ILX69-PBS in a CompactLogix™ system. When complete, please see Configuration by Controller Application 46 for module-specific configuration parameters.

#### Creating a New Project

- 1 Open the **FILE** menu, and select **NEW**.

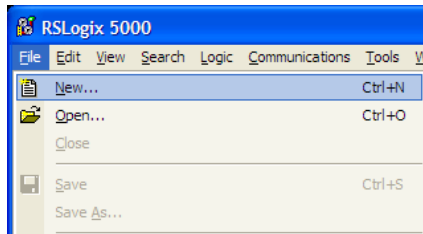

- 2 Select your controller **TYPE** and **REVISION 16** or newer.

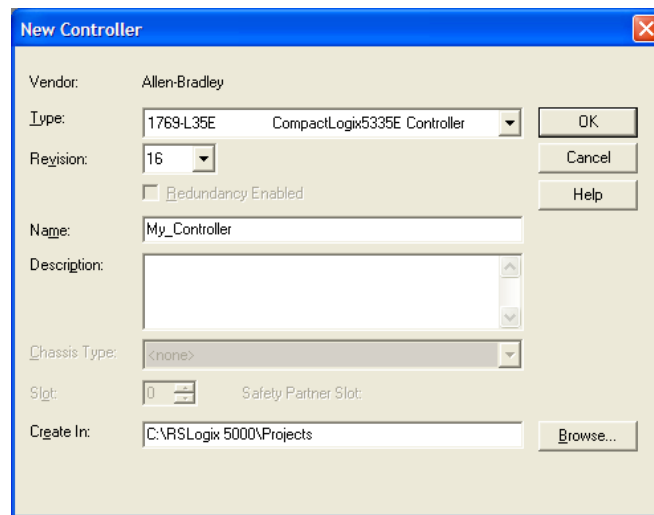

- 3 Click **OK**.
- 4 Right click on the **I/O configuration > CompactBus Local** of the controller project.

5 Select **New Module** from the context menu as shown below.

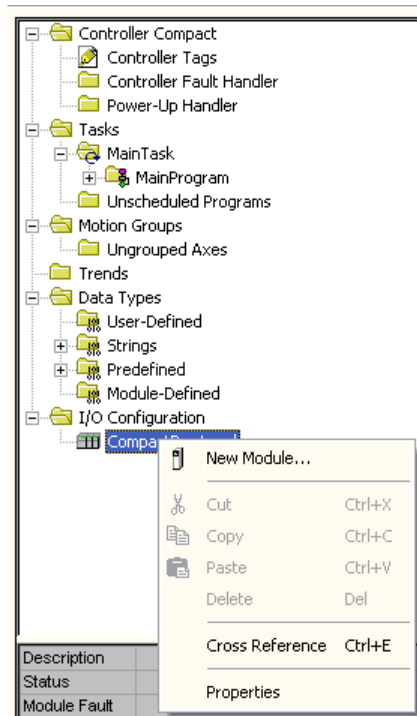

The following dialog box appears.

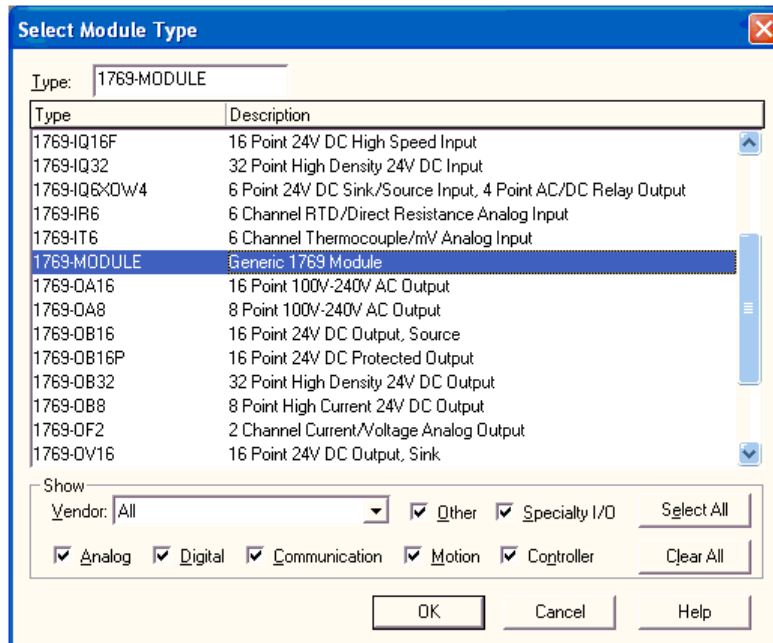

6 Select "**1769-MODULE Generic 1769 module**" and click **OK**. The *Module Properties* dialog will open.

### Module Properties 1

- 1 The communications parameters for the module should be set as shown in the dialog below.

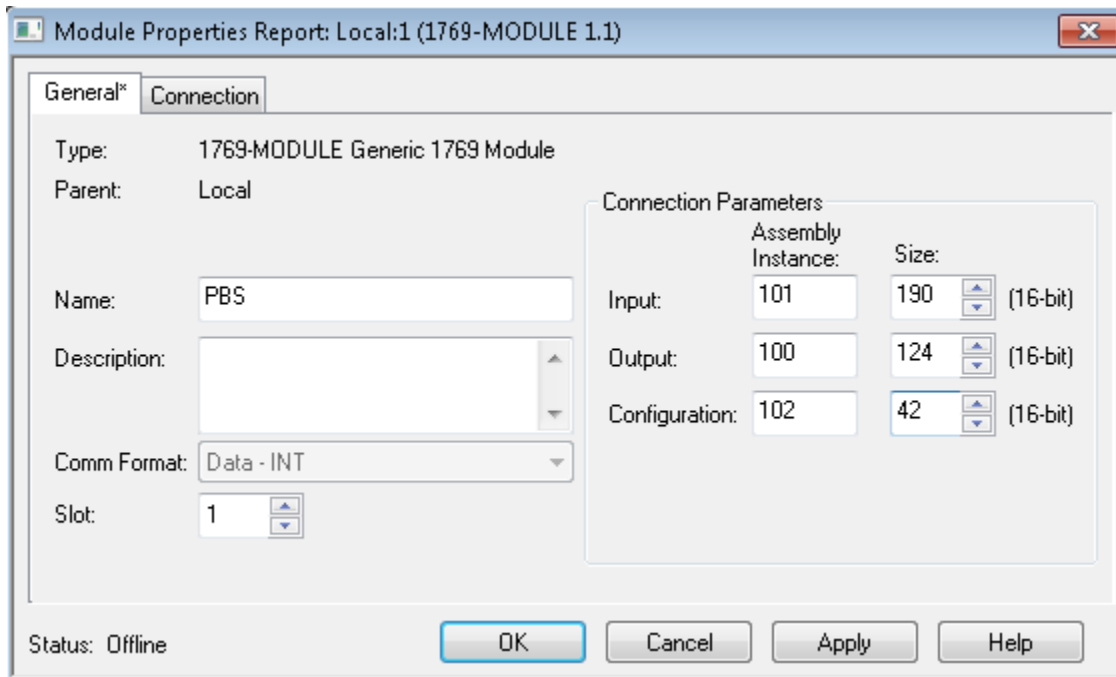

- 2 Enter **PBS** as the **NAME** and enter a short description for the module.
- 3 Select the **Slot** number in which the module is installed in the CompactLogix system. It must be within 2 slots of a power supply.
- 4 Select **Data - INT** as the **Comm\_Format**.
- 5 Set the *Connection Parameters* as they are shown in the dialog above.
- 6 Select **Next >>** or **OK** for the next configuration dialog.

Module Properties 2

The Requested Packet Interval RPI is shown in the following dialog. Within this time interval, the I/O data between module and controller are exchanged.

- 1 Edit the **REQUESTED PACKET INTERVAL (RPI)** value, if needed.

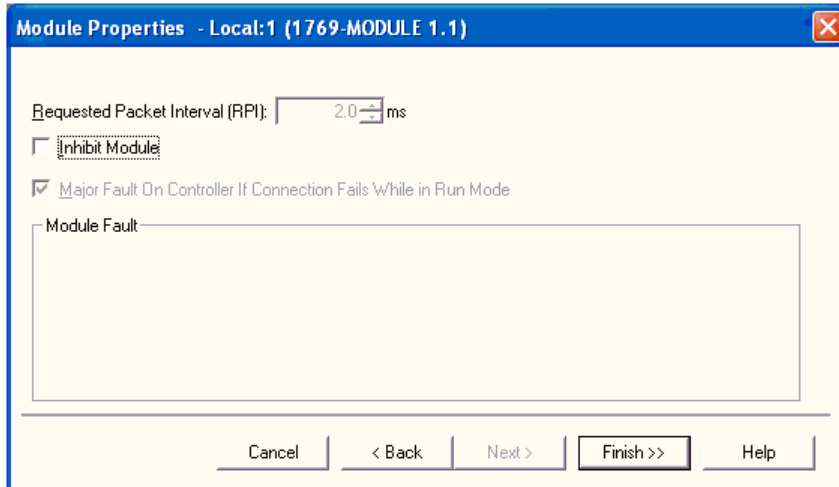

- 2 Click **Finish>>**
- 3 Save the project.

### 5.1.3 Importing the Ladder Rung

- 1 In the *Controller Organization* window, expand the **TASKS** folder and subfolder until you reach the **MAINPROGRAM** folder.
- 2 In the **MAINPROGRAM** folder, double-click to open the **MAINROUTINE** ladder.
- 3 Select an empty rung in the new routine, and then click the right mouse button to open a shortcut menu. On the shortcut menu, choose **IMPORT RUNGS**.

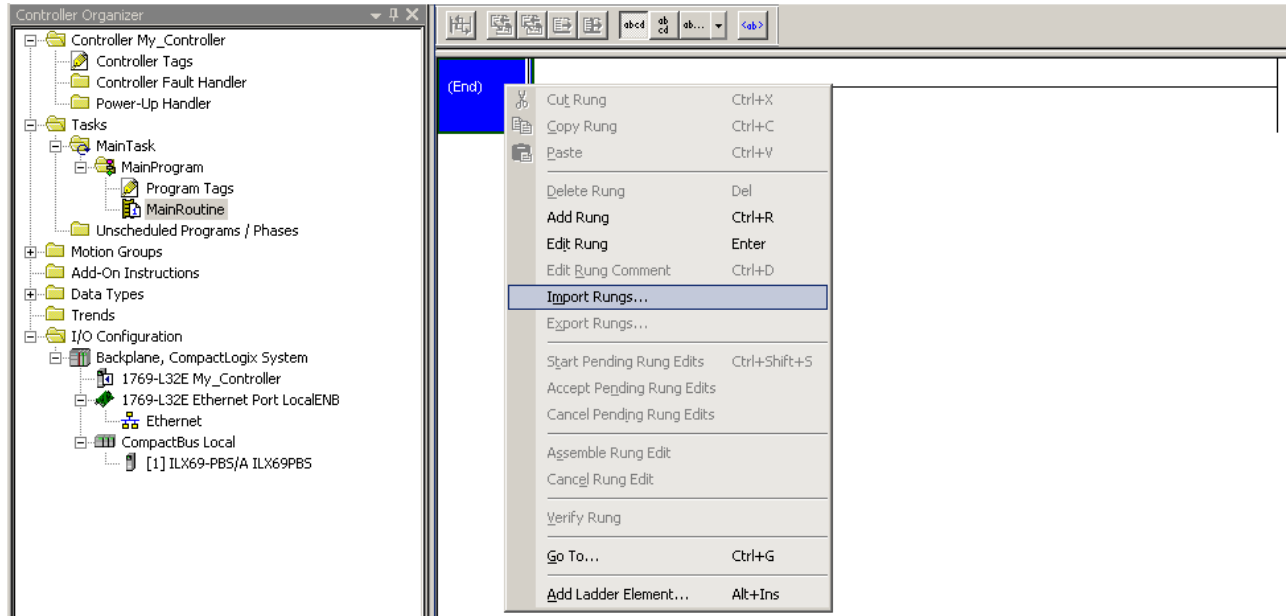

- 4 Navigate to the location on your PC where the **.L5X** Add-On Instruction (for example, *My Documents* or *Desktop*) is saved. Select **IMPORT...**

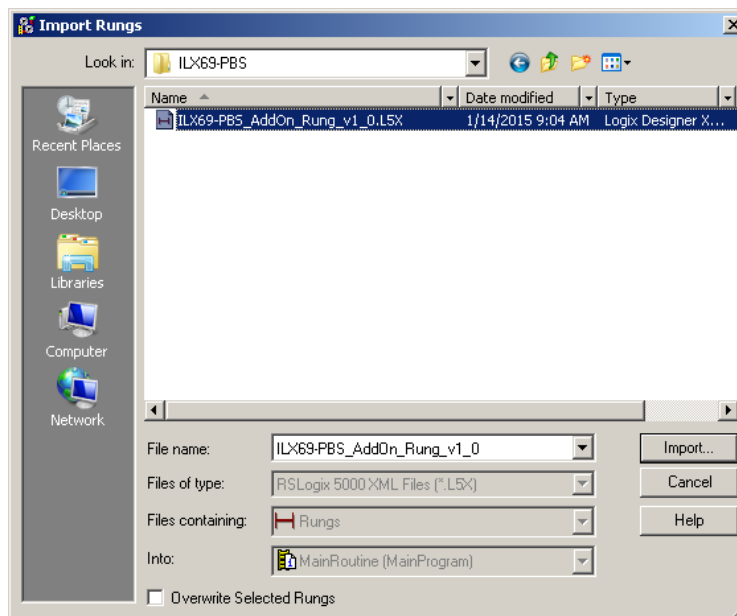

This action opens the *Import Configuration* dialog box, showing the controller tags that will be created.

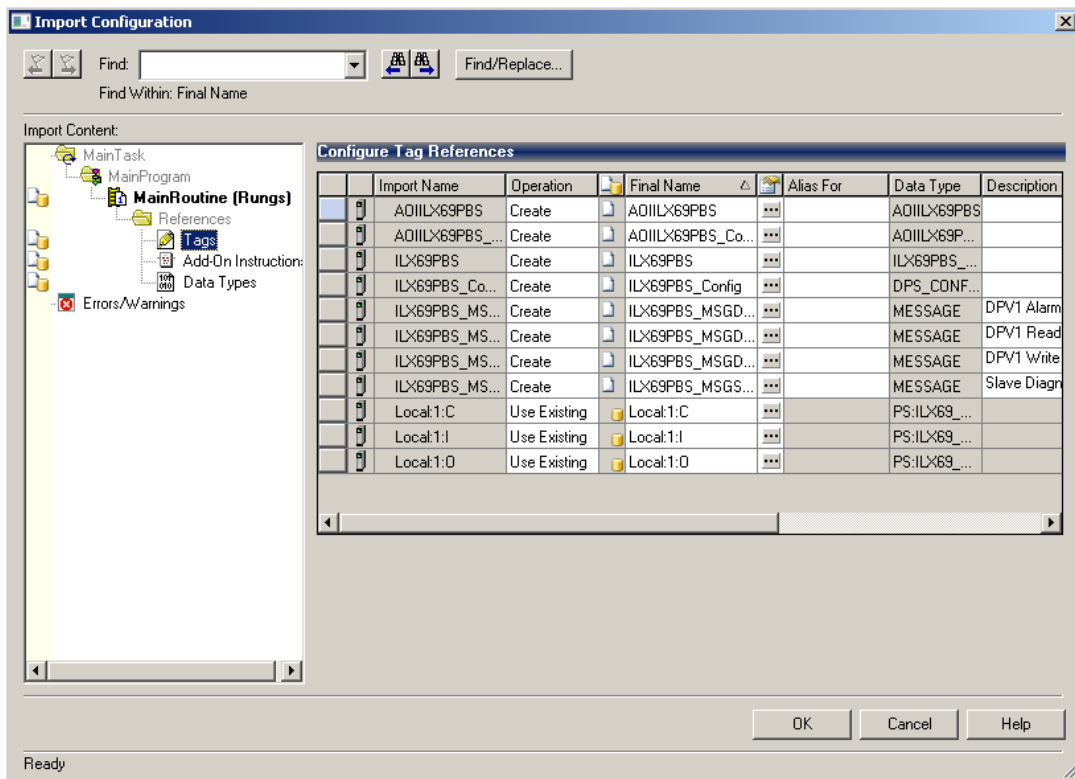

- Verify that the slot number is correct for the module in the *Local:x* tags. This must match the physical slot number location of the ILX69-PBS in the CompactLogix™ bus.

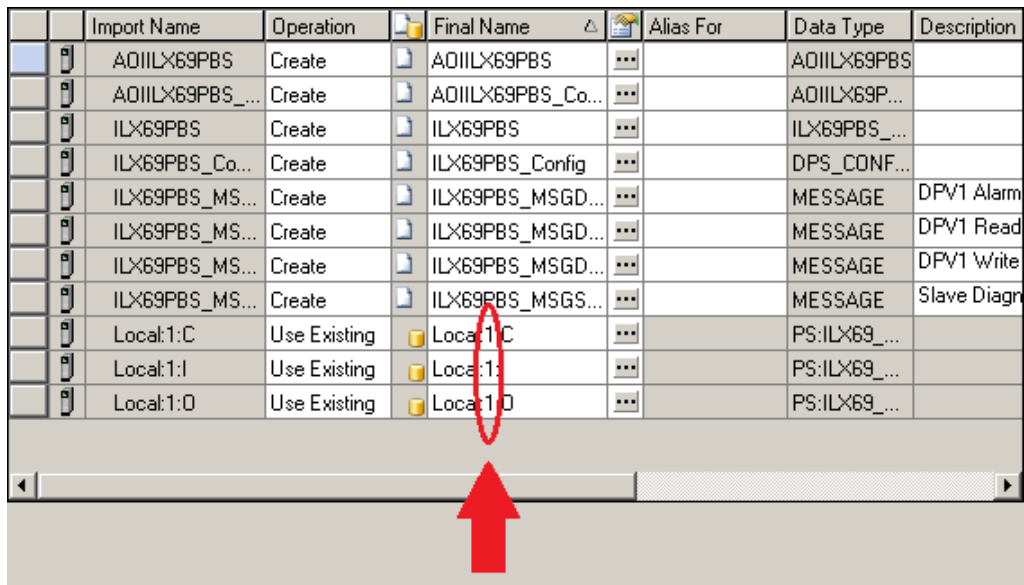



- 6 Click **OK** to confirm the import.

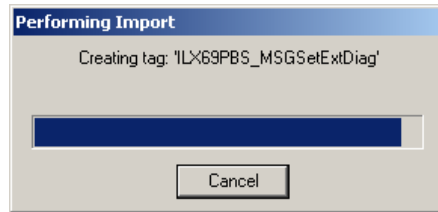

When the import is completed, the new Add-On Instruction rung will appear in the ladder.

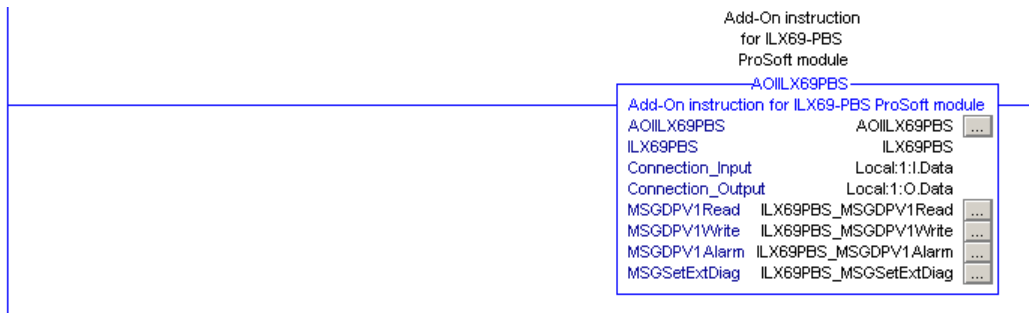

The procedure has also imported new user-defined data types, controller tags and the Add-On instruction for your project.



- 7 Save the project.

Read Request

When the AOI is imported into the project, the ILX69-PBS MSG tags reference slot 1 in its path configuration. If the ILX69-PBS is not located in slot 1, you will need to edit the MSG instruction Communication Path to the proper slot number.

- 1 Locate the MSG instructions within the ILX69-PBS AOI rung.

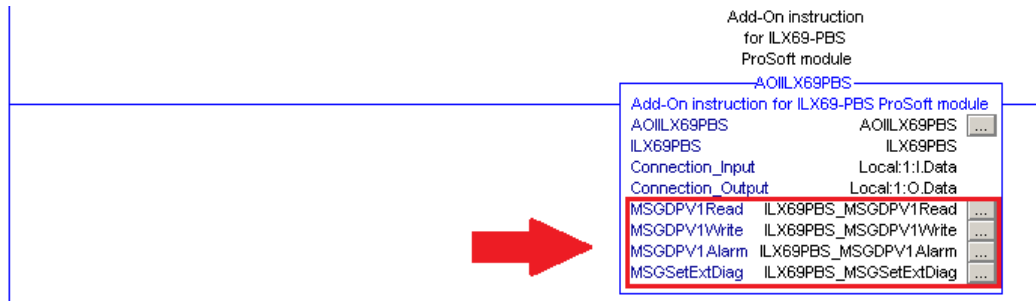

- 2 To edit a MSG instruction, click on the "..." box to open the *Message Configuration* window.

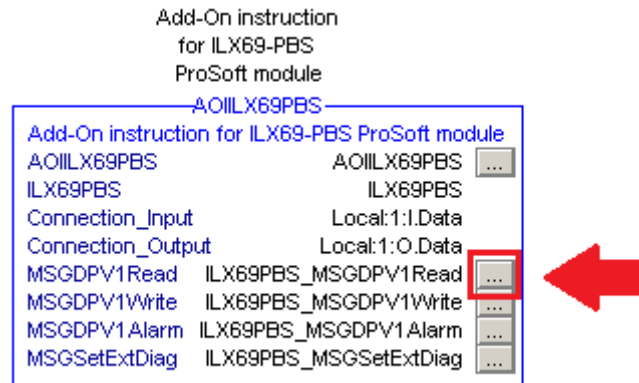

- 3 Select the **COMMUNICATION** tab at the top of the window. Click **BROWSE...** to open the *Message Path Browser* window.

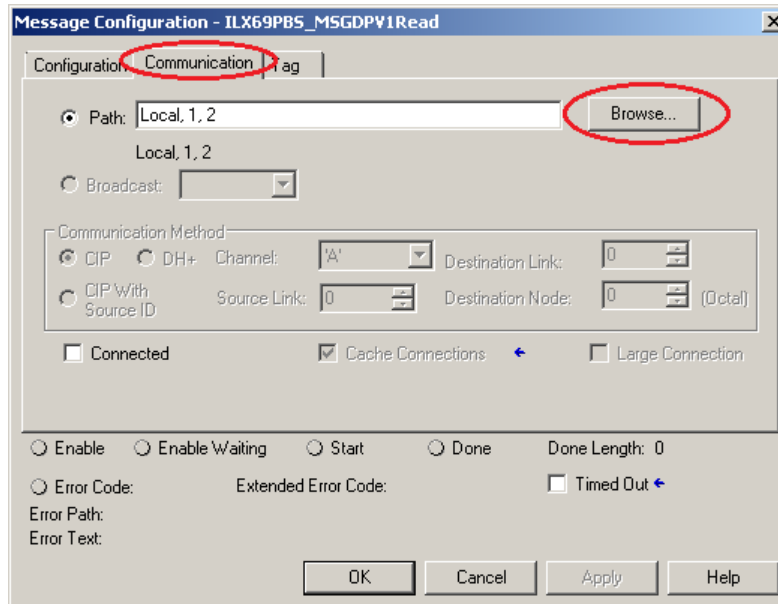

- 4 In the *Message Path Browser* window, select the slot location of the ILX69-PBS. The *Path* field updates when the module is selected. Click **OK**.

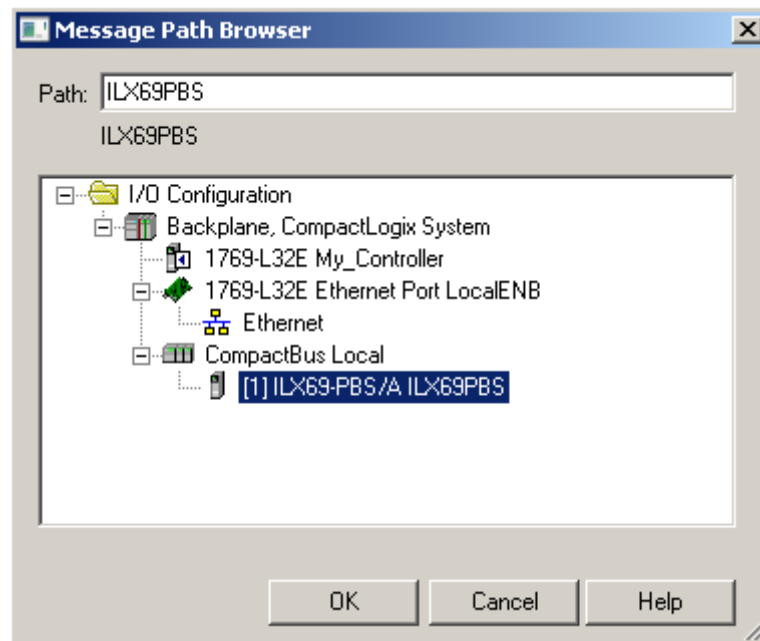

- 5 Back In the *Message Configuration* window, the *Path* field shows the ILX69-PBS properly in place. Click **APPLY**, then click **OK**.

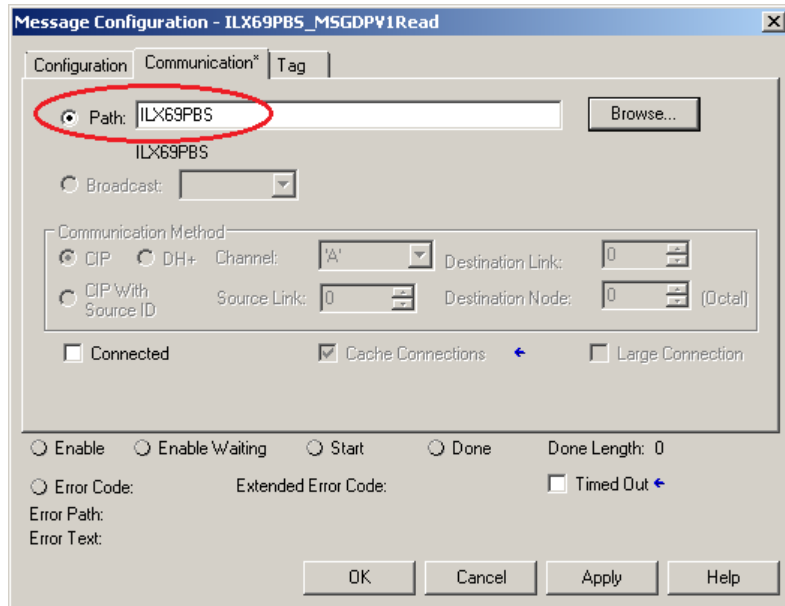

- 6 Repeat these steps for each MSG instruction in the ILX69-PBS AOI.
- 7 Save the project. It is ready to be downloaded to the CompactLogix™ controller.

## 5.2 Slave Configuration

The following section details the basics the ILX69-PBS configuration.

There are two ways to configure the ILX69-PBS:

- **Configuration by Master**  
With the PROFIBUS master and ILX69-PBS connected on the network, the slave configuration is sent from the master to the ILX69-PBS during PROFIBUS network start-up.
- **Configuration by Controller Application**  
The slave configuration can be loaded via configuration parameters from the CompactLogix™ PLC program to the ILX69-PBS.

### 5.2.1 GSD File

A GSD (Generic Station Description) file is an electronic datasheet used for a particular PROFIBUS slave device. The ILX69-PBS GSD file contains the information that is specific to the ILX69-PBS.

The ILX69-PBS GSD file is named "PSFT0EE1.GSD". It is located on the ILX69-PBS webpage at [www.prosoft-technology.com](http://www.prosoft-technology.com). You must provide this file to the PROFIBUS master configuration software. Refer to the master's documentation of how to import GSD files.

### 5.2.2 Configuration by Master

Configuration by Master is the easiest way to configure the slave. The ILX69-PBS sample ladder and AOI contains the use of this method. This example is described in section Studio 5000 Example Program.

During the network startup phase, the PROFIBUS master sends the expected slave configuration over the network to compare it with the real configuration of the slaves connected to the bus. The ILX69-PBS automatically takes over the configuration which is sent by the master during its comparison of the configuration. This method is activated by default, since the parameter "Force User Config" in the configuration area is set to 0. The only setting required by the user is setting the Address rotary switches on the front of the ILX69-PBS.



**Note:** The PROFIBUS DP master can send a new configuration to the slave at any time. This can cause inconsistency if the new configuration does not match to the controller application. A safer method can be done by "Configuration by Controller Application" located in the next section. With this method, the slave module does not start any communication as long as the slave configuration and the master configuration do not match to each other.

### 5.2.3 Configuration by Controller Application

The second option to configure the ILX69-PBS is through the controller application. If you're unable to install the AOP due to company policy or other reasons, you will need to manually configure the module through the controller application.

The "Force User Config" parameter in this array must be set to 1. With this method, the ILX69-PBS will not start any network communication unless the master and ILX69-PBS configuration match. The following table outlines the mapping of the configuration data image.

Word Offset	Configuration word	Data type	Low/High Byte	Description	Valid values
0	Local:1:C.Data[0]	INT	LOW Byte	Reconfiguration Event 0	Reserved, set to 0
			HIGH Byte	Reconfiguration Event 1	
1	Local:1:C.Data[1]	INT	LOW Byte	Reconfiguration Event 2	Reserved, set to 0
			HIGH Byte	Reconfiguration Event 3	
2	Local:1:C.Data[2]	INT	LOW Byte	Bus Address	0 to 125 0 = ForceMasterConfig 1 = ForceUserConfig
			HIGH Byte	Force User Configuration	
3	Local:1:C.Data[3]	INT		Reserved	
4	Local:1:C.Data[4]	INT		Watchdog Time	0 to FFFFh
5	Local:1:C.Data[5]	INT		Number of valid config bytes (starting with Local:1:C.Data[8])	2 to 48
6	Local:1:C.Data[6]	INT		Reserved	
7	Local:1:C.Data[7]	INT		Reserved	
8	Local:1:C.Data[8]	INT	LOW Byte	Module 1 Type	
			HIGH Byte	Module 1 Length	
9	Local:1:C.Data[9]	INT	LOW Byte	Module 2 Type	
			HIGH Byte	Module 2 Length	
	...			...	
	...			...	
31	Local:1:C.Data[31]	INT	LOW Byte	Module 24 Type	
			HIGH Byte	Module 24 Length	
32	Local:1:C.Data[32]	BOOL	-	IP Config flags 1, Static or Dynamic	0 or 1
33	Local:1:C.Data[33]	BOOL	-	IP Config flags 2, Static or Dynamic	0 or 1
34	Local:1:C.Data[34]	INT	-	IP Configuration	0 = BOOTP 1 = DHCP 2 = FIXED IP
35	Local:1:C.Data[35]	SINT	LOW Byte	IP Address	00.00.00.00 through FF.FF.FF.FF
			...		
			...		
			HIGH Byte		

Word Offset	Configuration word	Data type	Low/High Byte	Description	Valid values
37	Local:1:C.Data[37]	SINT	LOW Byte	Net Mask	00.00.00.00 through FF.FF.FF.FF
			...		
			HIGH Byte		
39	Local:1:C.Data[39]	SINT	LOW Byte	Gateway Address	00.00.00.00 through FF.FF.FF.FF
			...		
			HIGH Byte		
41	Local:1:C.Data[41]	-	-	Reserved	Set to 0

### 5.2.4 Configuration Parameters

#### Bus Address

The ILX69-PBS has two rotating address switches to set the network address from 0 to 99. If you need to assign the ILX69-PBS to an address above 99, set both address switches to 0. The module will take the address parameter from the configuration data array.

Address Switches	Configuration Address Parameter	Active Bus Address	Description
1 to 99	N/A	1 to 99	Address switches are valid
0	0 to 125	0 to 125	Configuration parameter is valid
0	> 125	N/A	Invalid (will cause an initialization error)

#### Force User Configuration

If this value is set to 1, the ILX69-PBS will not start network communication until the master and slave configurations match.

If this value is set to 0, the slave accepts the configuration sent from the master.

Watchdog Timeout

The ILX69-PBS supervises its I/O exchange with the controller within a specific time frame. If the controller does not update the output data within this time, the slave stops the cyclic data exchange with the master and goes into a safe state.

If the 'ForceUserConfiguration' parameter is set to 0, the ILX69-PBS automatically calculates a timeout value by the RPI (Requested Packet Intervall). The calculated watchdog calculates to 2x the RPI (+/- 5ms). The smallest watchdog value is 15 ms. The module rounds the watchdog value to multiples of 5 ms.

$$\text{WATCHDOG\_TIME (ms)} = \text{MAX} ( 2 \times \text{RPI} )$$

If the "ForceUserConfiguration" parameter is set to 1, the ILX69-PBS will take the watchdog value from the configuration array. Make sure the watchdog value is not smaller than the RPI. The ILX69-PBS rounds the watchdog to multiples of 5ms.

Number of Valid Configuration Bytes

This parameter holds the number of valid configuration bytes that define PROFIBUS Input/Output modules.

Module Type / Module Length

The ILX69-PBS offers a flexible, modular composition of its I/O data. Parts of the input and output image can be viewed as single modules. The master can put the different modules from the ILX69-PBS to different locations in its I/O area. The individually configured modules are mapped linearly in the I/O area of the ILX69-PBS. It is possible to configure up to 24 I/O modules. A module is defined by a Module Type and its Module Length:

Parameter	Data Type	Valid values	Description
Module Type	SINT	0 = IN Byte 1 = IN Word 2 = OUT Byte 3 = OUT Word 4 = IN Byte con 5 = IN Word con 6 = OUT Byte con 7 = OUT Word con 8 = Blank space	Input Byte without consistence Input Word without consistence Output Byte without consistence Output Word without consistence Input Byte with consistence Input Word with consistence Output Byte with consistence Output Word with consistence Blank space
Module Length	SINT	0 1 2 3 4 5 6 7 8 9	1 Byte/Word 2 Byte/Word 3 Byte/Word 4 Byte/Word 8 Byte/Word 12 Byte/Word 16 Byte/Word 20 Byte/Word 32 Byte/Word 64 Byte/Word





**Note:** Please notice the definition of Input/Output modules and do not confuse them with the input and output area of the ILX69-PBS in the controller memory map.

Inputs and Outputs modules are always defined from viewpoint of the PROFIBUS master. If you configure an Output module, you will see this in the input area of the ILX69-PBS, because the input area of the controller memory map is the output area from point of view of a PROFIBUS master.

The same applies to an Input module. If you define an Input module, it is mapped in the output area of the controller memory map, because the output area of the ILX69-PBS is the input area from viewpoint of a PROFIBUS master.

The sample ladder and AOI can also be used as an example for a module configuration by the controller application. You only have to set the "ForceUserConfiguration" parameter from 0 to 1 in the configuration array. Section Studio 5000 Example Program explains the pre-defined configuration parameter of the sample ladder/AOI.

## 5.3 SD Card

### 5.3.1 Start-up Behavior with or without SD Card

The start-up behavior of the ILX69-PBS depends on whether an SD memory card is inserted in the module or not.

#### Start-up without Memory Card

On power-up, the ILX69-PBS and the firmware are started and the configuration data is loaded from the CompactLogix processor using the Local:x:C.Data array into the ILX69-PBS internal flash memory. Depending on the amount of stored configuration data, this can last for approximately 4 seconds.

#### Start-up with Memory Card

The ILX69-PBS supports firmware upgrade utilizing an optional SD card. Contact ProSoft technical support to obtain this firmware image. Firmware can also be loaded via the ILX69-PBS webpage. Configuration of the module is always obtained from the Local:x:C.Data array from the CompactLogix processor.

On power-up, the firmware data are restored from the SD memory card flash image into the ILX69-PBS internal flash memory only when the ILX69-PBS is not connected over the backplane to a CompactLogix processor. The following is the power-up sequence:

- After return of power, the SYS LED indicates a fast blinking in green for approximately 10 seconds. During this time the SD memory card can be removed from the module to prevent the data transfer.
  - After 10 seconds, the following files are transferred from the SD memory card into the non-volatile flash memory of the ILX69-PBS:
    - Firmware \*.nxf
    - Web pages

This operation takes (typically) up to 30 seconds. During this operation the SYS LED is static yellow.

- When complete, the new firmware starts automatically and the ILX69-PBS boots with the new configuration. The COM LED illuminates or blinks as described in section Communication Status. Connection over the backplane to the CompactLogix processor can then be restored.

### 5.3.2 **STARTUP.INI File**

The STARTUP.INI file contains the following:

```
1 [Global]
2 Notify=10
3 Restore=always
4 RestorePoint=SDMMC:/backup
```

**Notify=10:** The value for 'Notify' is '10'. It takes 10 seconds to copy the files from the SD memory card to the internal flash of the ILX69-PBS.

**Restore=always:** The second stage bootloader copies the files in any case.

**RestorePoint=SDMMC:/backup:** All data stored under the backup folder is copied to the SD memory card.



**Note:** The STARTUPINI file is automatically created if 'Store' and

Write to SD Card

are used. The user does not need to create this file.

### 5.3.3 **Reset Device to Factory Settings with Memory Card**

Using a memory card that has the basic firmware stored on it, the ILX69-PBS can be restored back to factory settings.

- 1 Copy the STARTUP.INI file and the backup directory (including all subdirectories) from the ILX69-PBS webpage at [www.prosoft-technology.com](http://www.prosoft-technology.com) into the root directory of an empty memory card.
- 2 Prepare the memory card and reset the module to the factory settings as described in section Steps for Project File Backup and SD Card Handling.

## 6 Communication

### In This Chapter

- ❖ Studio 5000 PROFIBUS Data Values .....51
- ❖ I/O Communication and Memory Map .....52
- ❖ Acyclic Messaging .....60

### 6.1 Studio 5000 PROFIBUS Data Values

The ILX69-PBS PROFIBUS network data values (input and output) are located in the Controller Tags of Studio 5000.

#### 6.1.1 PROFIBUS Network Input Data

PROFIBUS network Input data is sent from the slave to the Master. This data is stored in the *ILX69PBS.PROFIBUSDATA.INPUT* array.

[-] ILX69PBS	{ ... }
[-] ILX69PBS.PROFIBUSDATA	{ ... }
[+] ILX69PBS.PROFIBUSDATA.Output	{ ... }
[-] ILX69PBS.PROFIBUSDATA.Input	{ ... }
[+] ILX69PBS.PROFIBUSDATA.Input[0]	0
[+] ILX69PBS.PROFIBUSDATA.Input[1]	0
[+] ILX69PBS.PROFIBUSDATA.Input[2]	0
[+] ILX69PBS.PROFIBUSDATA.Input[3]	0
[+] ILX69PBS.PROFIBUSDATA.Input[4]	0
[+] ILX69PBS.PROFIBUSDATA.Input[5]	0

### 6.1.2 PROFIBUS Network Output Data

PROFIBUS network Output data is sent from the Master to the slave. This data is stored in the `ILX69PBS.PROFIBUSDATA.OUTPUT` array.

[-] ILX69PBS	{...}
[-] ILX69PBS.PROFIBUSDATA	{...}
[-] ILX69PBS.PROFIBUSDATA.OUTPUT	{...}
[+] ILX69PBS.PROFIBUSDATA.OUTPUT[0]	0
[+] ILX69PBS.PROFIBUSDATA.OUTPUT[1]	0
[+] ILX69PBS.PROFIBUSDATA.OUTPUT[2]	0
[+] ILX69PBS.PROFIBUSDATA.OUTPUT[3]	0
[+] ILX69PBS.PROFIBUSDATA.OUTPUT[4]	0

## 6.2 I/O Communication and Memory Map

The following sections contain the I/O memory mappings of the ILX69-PBS. The I/O area is used for communication status and cyclic I/O data.

### 6.2.1 I/O Arrays Overview

#### Input Array

Below is a summary of the register layout of the input area of the ILX69-PBS. The offset values are defined in bytes.

Offset	Register Type	Name
0	Device Status Register	Status Bits
1	Reserved	Reserved
2	Reserved	Reserved
3	Reserved	Reserved
4	Firmware Revision	Minor Version
5	Firmware Revision	Major Version
6 to 7	Reserved	Reserved
8 to 9	Slave Status Information	ExtStaSelect
10 to 11	Slave Status Information	ExtStaLen
12 to 13	Slave Status Information	Baudrate
14	Slave Status Information	Busaddress
15	Slave Status Information	UserFlags
16 to 17	Slave Status Information	Ident
18 to 19	Slave Status Information	TaskState
20 to 21	Slave Status Information	InputDataLen

Offset	Register Type	Name
22 to 23	Slave Status Information	OutputDataLen
24 to 25	Slave Status Information	ErrorCount
26	Slave Status Information	LastError
27	Slave Status Information	Reserved
28 to 29	Slave Status Information	WatchdogTime
30 to 31	Slave Status Information	IrqCounter
32 to 37	Slave Status Information	Dpv1StatusRegister
38 to 39	Slave Status Information	Reserved
40 to 135	Slave Status Information	ExtStatusInfo[96]
136 to 379	PROFIBUS Output Area	PBOutputData

### Output Array

Below is a summary of the register layout of the output area of the ILX69-PBS. The offset values are defined in bytes.

Offset	Register Type	Name
0	Device Command Register	Command Bits
1	Device Command Register	Reserved
2	Device Command Register	Reserved
3	Device Command Register	ExtStaSelect
4 to 248	PROFIBUS Input Area	PBInputData, 244 bytes

## 6.2.2 Input Array

### Status Registers

The ILX69-PBS uses the first 4 bytes of the PLC input area to transfer device status register information. The *Status Registers* contain the ILX69-PBS communication status and command status. The mapping is shown in the table below.

#### Device State Register

Byte Offset	Structure Member	Data Type	Description
0	MSB	SINT	Module Status Bits, see table below
1	Reserved	SINT	Reserved
2	BTO	SINT	Block Transfer Out
3	BTI	SINT	Block Transfer In

**MSB - Module Status Bits**

Bit Offset	Structure Member	Data Type	Description
0	Reserved	BOOL	Reserved, set to 0
1	Reserved	BOOL	Reserved, set to 0
2	Reserved	BOOL	Reserved, set to 0
3	Reserved	BOOL	Reserved, set to 0
4	Reserved	BOOL	Reserved, set to 0
5	COM	BOOL	Communication - When this bit is set, the communication has started and the module is engaged in cyclic data exchange with the master. 0 = Not communicating, 1 = Communicating
6	RUN	BOOL	Run - When this bit is set, the module is ready for communication. Otherwise, an initialization error or incorrect parameterization has occurred. 0 = Not running, 1 = Running
7	RDY	BOOL	Ready - When this bit is set, the module is operational. The RDY bit should always be set by the module. If this bit is not set, a system error has occurred and the communication between controller and module is not active. 0 = Not ready, 1 = Ready

*Firmware Revision*

This data field contains the current *Firmware Revision* of the ILX69-PBS. The Minor revision is the low byte and the Major revision is the high byte. The mapping is shown below.

Byte Offset	Structure Member	Data Type	Description
4	FwMinor	SINT	Firmware Minor Revision
5	FwMajor	SINT	Firmware Major Revision
6 to 7	Reserved	-	Reserved

**Example:**

If FwMajor = 10 and FwMinor = 1 then the firmware revision is 10.1.

Due to a different internal firmware numbering scheme than Major/Minor version, the following method is used to utilize this information to support requirements for a major revision/minor revision of the CompactLogix controller. Because the first release of the ILX69-PBS internal firmware will start with at least V01.000, the first firmware version in Major Minor scheme will be at least 10.00. Details are provided in the table below.

FW Revision	FW Major	FW Minor
V01.000	10	00
V01.001	10	01
...		

Slave Status

A 128 byte *Slave Status* field is transferred to the user program via the input data area image. It contains the ILX69-PBS status, beginning with byte 8 of the input region. The status information encompasses 32 bytes of static information and 96 bytes reserved for the extended status field. The content of the extended status is controlled by the command "ExtStaSelect" byte in the Device Command Register in the user program (byte offset 8 to 9).

Byte Offset	Structure member	Data type	Description	Valid Values
8 to 9	ExtStaSelect	INT	Shows the extended status information that is currently transmitted in the field "Extended Status Information"	0 = No extended status information 1 = Firmware version 2 = Slave configuration 3 = Master configuration 4 = Parameter data 6 = Reserved
10 to 11	ExtStaLen	INT	Number of valid bytes in the region "Extended Status Information"	Depends on the selected extended status 0 = 0 Byte 1 = 32 Byte 2 = 49 Byte 3 = 49 Byte 4 = 33 Byte 6 = 80 Byte
12 to 13	Baudrate	INT	Baud Rate on PROFIBUS network	12000 = 12 MBaud 6000 = 6 MBaud 3000 = 3 MBaud 1500 = 1.5 MBaud 500 = 500 kBaud 187 = 187.5 kBaud 93 = 93.75 kBaud 9 = 9.6 kBaud 0 = Not detected
14	Busaddress	SINT	Bus Address of the slave	0 to 125
15	UserFlags	SINT	User Flags	D0 = Parameter data changed D1 = Configuration data changed D2 to D7 = Not Applicable
16 to 17	Ident	INT	Slave identification number	0EE1h
18 to 19	Reserved	INT	Reserved	Set to 0
20 to 21	InputDataLen	INT	Length of input data(*)	0 to 244
22 to 23	OutputDataLen	INT	Length of output data(*)	0 to 244
24 to 25	Reserved	INT	Reserved	Set to 0
26	Reserved	SINT	Reserved	Set to 0
27	Pad	SINT	Reserved	Set to 0
28 to 29	Watchdog Time	INT	Current watchdog time	5 to 65535 ms
30 to 31	IrqCounter	INT	Indication of bus activity	0 to 0xFFFF
32 to 37	Dpv1StatReg	INT	DPV1 Status Register	See following section
38 to 39	Reserved	SINT	Reserved	Reserved
40 to 135	ExtStatusInfo	SINT[96]	Extended Status Information	See following section



**(\*) Note:** The status information 'InputDataLen' and 'OutputDataLen' are related to the definition of inputs and outputs from point of view of a PROFIBUS master.

Example: If the 'OutputDataLen' indicates a value of 4 Bytes, then it is related to the input area of the ILX69-PBS, because the input area of the ILX69-PBS are outputs from point of view of a PROFIBUS master. The same relation applies to the status 'InputDataLen' and the output area of the ILX69-PBS.

### DPV1 Status Registers

The controller application program uses the DPV1 status registers as an indication that the network master has sent an unsolicited DPV1 Read/Write request. The first will contain two bits which indicate if a read or write needs to be processed. If this register contains a non-zero value, the slave's user program must create an appropriate response to this request by using a CIP MSG command (shown in Messaging section). The table below contains the mapping of these registers.

Byte Offset	Structure Member	Data Type	Data Type	Description
32	RWInd	SINT	Read/Write Indication	A Read/Write Request has been received
33	RWIndCnt	SINT	Read/Write Indication Counter	Increments on every new DPV1 request
34	MasterAdr	SINT	Master Address	Address of Requesting Master
35	Slot	SINT	Slot number	Requested Slot Number
36	Index	SINT	Index	Requested Index
37	DataLen	SINT	Date Length	Requested Data Length

### DPV1 Read/Write Indication Status Bits

Bit Offset	Structure Member	Data Type	Description
0	ReadReq	BOOL	1 = Indicates a Read Request
1	WriteReq	BOOL	1 = Indicates a Write Request
2	Reserved	BOOL	Reserved
3	Reserved	BOOL	Reserved
4	Reserved	BOOL	Reserved
5	Reserved	BOOL	Reserved
6	Reserved	BOOL	Reserved
7	Reserved	BOOL	Reserved





**Note:** Every DPV1 read or write request must be acknowledged by the PLC application program. Otherwise, the PROFIBUS master shuts down communication for both channels, V0 (cyclic IO data) and V1 (non-cyclic messages). This can cause unexpected lost of data between the master and the ILX69-PBS.

**Extended Status Information**

Via the extended status area, the ILX69-PBS is ready to transfer 96 bytes of extended status information to the controller application. The information transferred depends on the parameter "ExtStaSelect" in the "Device Command Register". This can be controlled by the application program.

If the controller application selects a specific extended status, it will be acknowledged by the ILX69-PBS in the status region in "ExtStaSelect".

If the ILX69-PBS does not acknowledge this selection, the extended information is invalid. The number of bytes within the extended status area depends on the selected status. The number of valid bytes are shown in the status area in "ExtStaLen".

**Extended Status 0: (Length 0 Byte):**

No extended status information transferred.

**Extended Status 1: Firmware (Length 32 Byte)**

Structure member	Data type	Description
FwName	SINT[8]	Firmware Name
FwType	SINT[8]	Firmware Type
FwVersion	SINT[8]	Firmware Version
FwDate	SINT[8]	Firmware Date

**Extended Status 2: Slave Configuration (Length 49 Byte)**

Structure member	Data type	Description
CfgLength	SINT	Number of valid configuration bytes
CfgByte1	SINT	Configuration byte 1
CfgByte2	SINT	Configuration byte 2
CfgByte3	SINT	Configuration byte 3
CfgByte4	SINT	Configuration byte 4
....	....	....
CfgByte48	SINT	Configuration byte 48

**Extended Status 3: Master Configuration (Length 49 Byte)**

Structure member	Data type	Description
CfgLength	SINT	Number of valid configuration bytes
CfgByte1	SINT	Configuration byte 1
CfgByte2	SINT	Configuration byte 2
CfgByte3	SINT	Configuration byte 3
CfgByte4	SINT	Configuration byte 4
....	....	....
CfgByte48	SINT	Configuration byte 48

**Extended Status 4: Parameter Data (Length 33 Byte)**

Structure member	Data type	Description
PrmLength	SINT	Number of valid parameter bytes
PrmByte1	SINT	Parameter byte 1
PrmByte2	SINT	Parameter byte 2
PrmByte3	SINT	Parameter byte 3
PrmByte4	SINT	Parameter byte 4
....	....	....
PrmByte32	SINT	Parameter byte 32

**Extended Status 5: DPV1-C1-Diag (Length 80 Byte)**

Structure member	Data type	Description
StaReqUsr	DINT	Status Request from User
StaMsgSen	DINT	Status Messages Sent
NegStaCnf	DINT	Negative Status Confirmations to User
DiagReqUsr	DINT	Diagnostic Requests from User
DiagMsgSen	DINT	Diagnostic Messages Sent
NegDiagCnf	DINT	Negative Diagnostic Confirmations to User
AlaReqUsr	DINT	Alarm Request from User
AlaMsgSen	DINT	Alarm Messages Sent
PosAlaCnf	DINT	Positive Alarm Confirmations to User
NegAlaCnf	DINT	Negative Alarm Confirmations to User
Requests	DINT	Requests
ImmNegCnf	DINT	Immediate Negative Confirmations
RW_Ind	DINT	Read/Write Indications to User
PosRWResp	DINT	Positive Read/Write Responses from User
NegRWResp	DINT	Negative Read/Write Responses from User
AlaAckInd	DINT	Alarm Acknowledge Indications

Structure member	Data type	Description
AlaAckResp	DINT	Alarm Acknowledge Responses
AlaAckErr	DINT	Alarm Acknowledge Errors
ErrRespUsr	DINT	Erroneous Responses from User
UnxRespUsr	DINT	Unexpected Responses from User

***ILX69-PBS Input Data (PROFIBUS Network Output Data)***

Starting at byte 136, the remainder of the ILX69-PBS input array is used for the PROFIBUS network output data sent from the master to the ILX69-PBS. The data is then transferred from the ILX69-PBS to the controller via the AOI. The maximum size of PROFIBUS network output data is 244 bytes.

**6.2.3 Output Array**

***Device Command Register***

The *Device Command Register* is transferred from the controller to the ILX69-PBS via the output data image. This register lies in the first 4 bytes of the output image.

**Device Command Register**

Byte Offset	Structure Member	Data type	Description
0	MCB	SINT	Module Command Bits, see table below
1	Reserved	SINT	Reserved
2	Reserved	SINT	Reserved
3	ExtStaSelect	SINT	Extended Status Information Select, see table below

**MCB - Module Command Bits**

Bit Offset	Structure Member	Data type	Description
0	Reserved	BOOL	Reserved
1	Reserved	BOOL	Reserved
2	Reserved	BOOL	Reserved
3	Reserved	BOOL	Reserved
4	Reserved	BOOL	Reserved
5	NRDY	BOOL	Not ready - With this bit, the user program can make a controlled start or stop of the ILX69-PBS communications with the PROFIBUS master.
6	INIT	BOOL	Initialization - With this bit, the user program can execute a Reset (Warmboot) of the ILX69-PBS.
7	RST	BOOL	Reset - With this bit, the user program can execute a Reset (Coldboot) of the ILX69-PBS.



**Important:** Using the RST Reset command will cause an immediate interruption in bus communication. The connection to the network master will be closed.

**ExtStaSelect - Extended Status Select**

This byte selects the extended status information to appear in the ExtStatusInfo Input area. See the previous section for more information of the structure.

Value	Meaning	Description
1	Firmware	Returns the Firmware Version structure to the Extended Status Information
2	Slave Configuration	Returns the Slave configuration structure to the Extended Status
3	Master Configuration	Returns the Master Configuration structure to the Extended Status
4	Parameter Data	Returns the Parameter Data structure to the Extended Status Information
5	Reserved	Reserved
6 and higher	Reserved	Reserved

ILX69-PBS Output Data (PROFIBUS Network Input Data)

Starting at byte 4, the remainder of the ILX69-PBS output array is used for the PROFIBUS network input data to be sent to the master.

**6.3 Acyclic Messaging**

PROFIBUS DP acyclic services are supported by the Studio 5000 programming tool by means of CIP messages using the "MSG" instruction.

**6.3.1 Supported PROFIBUS DP Messages**

Below are the PROFIBUS DP message functions supported by the ILX69-PBS.

Service	Cmd Code	Group	Description
DPS Diagnostic Request	0x040E		This service enables the user to send a single diagnostics request to a master.
DPV1 Class 1 Read Response	0x0485	DPV1	With this service, the slave module can respond to a DPV1 Read Request from the PROFIBUS master. This service works by utilizing the master address, Data size, Slot and Index indicated within the DPV1 Status Registers.
DPV1 Class 1 Write Response	0x0487	DPV1	With this service, the slave module can respond to a DPV1 Write Request from the PROFIBUS master. . This service works by utilizing the master address, Data size, Slot and Index indicated within the DPV1 Status Registers.
DPV1 Class 1 Alarm Request	0x0480	DPV1	This service is used to send a DPV1 Alarm Request message to a PROFIBUS master.



**Note:** The ILX69-PBS sample ladder and AOI contains an example for each of these services.

### 6.3.2 Standard Messaging

This section contains the description of the Standard Message supported by the ILX69-PBS.

#### DPS Diagnostic Request

The Diagnostic Request command can be used by the controller user application to generate a single diagnostic request to a master. The MSG instruction Request/Confirmation format is as follows.

#### FSPMS Set Slave Diag Request

Offset	Variable	Type	Description
0	ulSta	UINT32	Status = 0 (S_OK)
4	ulCmd	UINT32	Request = 0x040E
8	fExtDiagOverflow	UINT8	Set the bit to indicate that more diagnostic data are available as diagnostic data can be transferred with abExtDiagData[ ]
9	fExtDiagFlag	UINT8	If set, diagnostic is sent as extended diagnostic.
10	bRes[2]	UINT8	Reserved padding bytes, set to 0
11	bRes[2]	UINT8	Reserved padding bytes, set to 0
12	abExtDiagData[ ]	UINT8[237]	Diagnostic data block to be transferred

#### FSPMS Set Slave Diag Confirmation

Offset	Variable	Type	Description
0	ulSta	UINT32	Status 0 = Set Slave Diag successful 0 != Set Slave Diag failed
4	ulCmd	UINT32	Request = 0x040F

Status Code	Name	Description
0xC0000009	TLR_E_INVALID_PARAMETER	The parameter of the "SetSlaveDiag" request is invalid. Check if the length and consistency of the ExtDiagData[] are correct.

The content of `abExtDiagData[ ]` follows the PROFIBUS decoding of extended diagnostic data. The `abExtDiagData[ ]` can contain one or more diagnostic blocks. If the content does not follow these rules, the confirmation will be returned with an error. Following table describes the PROFIBUS-specified extended diagnostic blocks.

Extended Diag Block	Byte 0	Byte 1	Byte 2	Byte 3	Byte 4 to n	Note
Alarm Block	Header	Alarm Type	Slot Number	Alarm Specifier	DiagUserData[59 ]	2*
Status Block	Header	Status Type	Slot Number	Status Specifier	DiagUserData[59 ]	1*
Device-related Block	Header	User data	User data	User data	User data	2*
Module-related Block	Header	Module0...7	Module8...15	Module16...23	Module24...255	1*
Channel-related Block	Header	Channel	Error	-	-	1*

**Note:** The `FSPMS_SetSlaveDiag` service only sends the *Status*, *Module* and *Channel-related* Blocks.

The *Alarm* and the *Device-related* diagnostic blocks are listed here only to give an overview of PROFIBUS-defined Extended Diagnostic Blocks. These blocks cannot be sent with the service “`FSPMS_SetSlaveDiag`”. The *Alarm* Block will be transferred separately with the service “`FSPMS_C1_Alarm_Notification`”. The *Device-related* Block is reserved for DPV0 Slaves only.

**Example:**

The following example shows how to transmit an extended diagnostic with two blocks; one channel-related and one status block. The channel diagnostic reports an “Overload”. The status block reports a user-specific status with the string “HELP” in Slot1.

- FSPMSDiagReq	{...}	{...}		FSPMS_DPVO_SL...
+ FSPMSDiagReq.ulSta	16#0000_0000		Hex	DINT
+ FSPMSDiagReq.ulCmd	16#0000_040e		Hex	DINT 0x040E
+ FSPMSDiagReq.fExtDiagOverflow	16#00		Hex	SINT
+ FSPMSDiagReq.fExtDiagFlags	16#01		Hex	SINT
+ FSPMSDiagReq.bRes1	16#00		Hex	SINT
+ FSPMSDiagReq.bRes2	0		Decimal	SINT
- FSPMSDiagReq.abExtDiagData	{...}	{...}	Hex	SINT[238]
+ FSPMSDiagReq.abExtDiagData[0]	16#83		Hex	SINT Channel Diag: In Module 3
+ FSPMSDiagReq.abExtDiagData[1]	16#81		Hex	SINT Channel Diag: Output In Channel 2
+ FSPMSDiagReq.abExtDiagData[2]	16#24		Hex	SINT Channel Diag: Overload (1Bit)
+ FSPMSDiagReq.abExtDiagData[3]	16#08		Hex	SINT Status Diag: With 8 Bytes
+ FSPMSDiagReq.abExtDiagData[4]	16#a0		Hex	SINT Status Diag: Vendor Specific
+ FSPMSDiagReq.abExtDiagData[5]	16#00		Hex	SINT Status Diag: In Slot 1
+ FSPMSDiagReq.abExtDiagData[6]	16#00		Hex	SINT Staus Diag: No differentiation
+ FSPMSDiagReq.abExtDiagData[7]	'H'		ASCII	SINT Staus Diag: Data
+ FSPMSDiagReq.abExtDiagData[8]	'E'		ASCII	SINT Staus Diag: Data
+ FSPMSDiagReq.abExtDiagData[9]	'L'		ASCII	SINT Staus Diag: Data
+ FSPMSDiagReq.abExtDiagData[10]	'P'		ASCII	SINT Staus Diag: Data

It will use the following Message Instruction configuration:

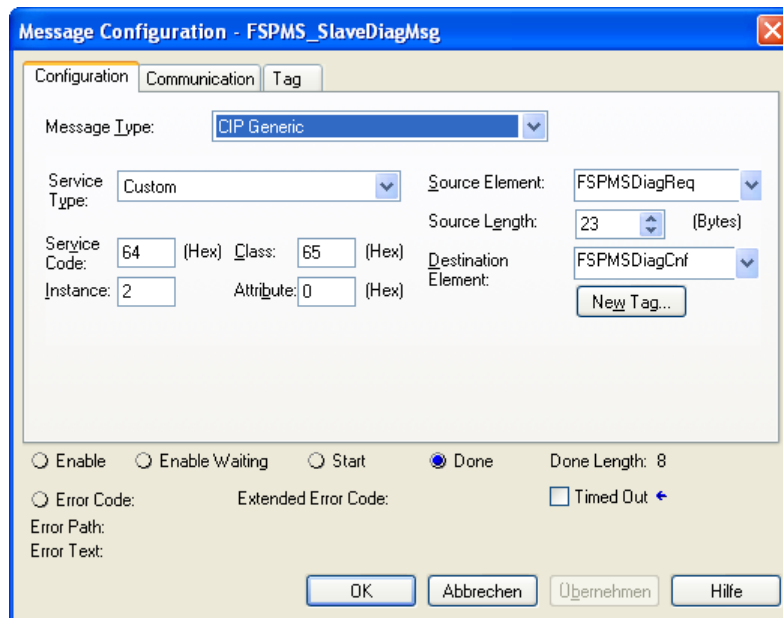

### 6.3.3 DPV1 Messaging

This section describes DPV1 messaging functions supported by the ILX69-PBS.



**Note:** Every DPV1 read or write request must be acknowledged by the PLC application program. Otherwise, the PROFIBUS master shuts down communication for both channels, V0 (cyclic IO data) and V1 (non-cyclic messages). This can cause unexpected lost of data between the master and the ILX69-PBS.

#### DPV1 Read

The DPV1 Class 1 Read Response message is used by the slave to reply to a Master DPV1 Read Request. The MSG instruction Response/Return format is as follows.

#### ILX69PBS.CONTROL.DPV1.Read.Response

Parameter	Data Type	Value	Description
.Status	DINT	0x0000	Status of Response message
.Command	DINT	0x0485	Command code
.SlotNumber	SINT	0 to 255	Slot number of data to be read
.Index	SINT	0 to 255	Index number of data to be read
.Length	SINT	0 to 240	Data length, 1 to 240 bytes
.Reserved1	SINT	0	Reserved
.ErrorDecode	SINT		Error code
.ErrorCode1	SINT		Detailed error code
.ErrorCode2	SINT		User-specific error code
.Reserved2	SINT	0	Reserved



Parameter	Data Type	Value	Description
.Data	SINT[240]		Read Response Data

**ILX69PBS.CONTROL.DPV1.Read.Return**

Offset	Data Type	Value	Description
.Status	DINT	0x0000	Status of Return message
.Command	DINT	0x0485	Command code
.SlotNumber	SINT	0 to 255	Slot number of data to be read
.Index	SINT	0 to 255	Index number of data to be read
.Length	SINT[240]	0 to 240	Data length
.Reserved1	SINT	0	Reserved byte

DPV1 Write

The DPV1 Class 1 Write Response is used by the slave to reply to a master DPV1 write request. The MSG instruction Request/Response format is as follows.

**ILX69PBS.CONTROL.DPV1.Write.Request**

Parameter	Data Type	Value	Description
.Status	DINT	0x0000	Status of Request message
.Command	DINT	0x0487	Command code
.SlotNumber	SINT	0 to 255	Slot number of data to be written
.Index	SINT	0 to 255	Index number of data to be written
.Length	SINT	0 to 240	Data length, 1 to 240 bytes
.Reserved1	SINT	0	Reserved
.ErrorDecode	SINT		Error code
.ErrorCode1	SINT		Detailed error code
.ErrorCode2	SINT		User-specific error code
.Reserved2	SINT	0	Reserved
.Data	SINT[240]		Write Request Data

**ILX69PBS.CONTROL.DPV1.Write.Response**

Parameter	Data Type	Value	Description
.Status	DINT	0x0000	Status of Request message, 0 = OK
.Command	DINT	0x0487	Command code
.SlotNumber	SINT	0 to 255	Slot number of data to be written
.Index	SINT	0 to 255	Index number of data to be written
.Length	SINT	0 to 240	Data length, 1 to 240 bytes

Parameter	Data Type	Value	Description
.Reserved1	SINT	0	Reserved
.ErrorDecode	SINT		Error code
.ErrorCode1	SINT		Detailed error code
.ErrorCode2	SINT		User-specific error code
.Reserved2	SINT	0	Reserved

DPV1 Alarm

The DPV1 Class 1 Alarm Request is used to indicate a DPV1 Alarm to the master. The MSG instruction Request/Response format is as follows.

**ILX69PBS.CONTROL.DPV1.Alarm.Request**

Parameter	Data Type	Value	Description
.Status	DINT	0x0000	Status of Alarm Request message
.Command	DINT	0x0221C	Command code
.SlaveAddress	SINT		Slave address
.AlarmType	SINT		Type of received alarm specified
.SlotNumber	SINT	0 to 255	Slot number module causing alarm
.Specifier	SINT		Alarm specifier
.Function	SINT		
.Reserved	SINT	0	Reserved

**ILX69PBS.CONTROL.DPV1.Alarm.Response**

Parameter	Data Type	Value	Description
.Status	DINT	0x0000	Status of Alarm Request message, 0 = OK
.Command	DINT	0x0221C	Command code
.SlaveAddress	SINT		Slave address
.AlarmType	SINT		Type of received alarm specified
.SlotNumber	SINT	0 to 255	Slot number module causing alarm
.Specifier	SINT		Alarm specifier
.Function	SINT		
.ErrorDecode	SINT		Error code
.ErrorCode1	SINT		Detailed error code

Parameter	Data Type	Value	Description
.ErrorCode2	SINT		User-specific error code

DPV1 Error Codes

Below are the PROFIBUS DPV1 error codes.

**Error Code 1**

Bit 7	Bit 6	Bit 5	Bit 4	Bit 3	Bit 2	Bit 1	Bit 0
				Error Code (see below)			
Error Class (see below)							

Error Class	Description	Error Code
0 to 9	Reserved	
10	Application	0 = Read Error 1 = Write Error 2 = Module Failure 3 to 7 = Reserved 8 = Version Conflict 9 = Feature not Supported 10 to 15 = User Specific
11	Access	0 = Invalid Index 1 = Write Length Error 2 = Invalid Slot 3 = Type Conflict 4 = Invalid Area 5 = State Conflict 6 = Access Denied 7 = Invalid Range 8 = Invalid Parameter 9 = Invalid Type 10 to 15 = User Specific

Error Class	Description	Error Code
12	Resource	0 = Read Constrain Conflict 1 = Write Constrain Conflict 2 = Resource Busy 3 = Resource Unavailable 4 to 7 = Reserved 8 to 15 = User Specific
13 to 15	User Specific	

**Error Code 2**

An error code 2 is application specific.

**6.3.4 CIP Messaging Error Codes**

This section includes errors codes and conditions that can occur when using the CIP messaging commands.

Your application should be constructed in a manner in which it catches the two possible error cases:

- CIP Message instruction failed
- The requested command returns an error in its request confirmation



**Note:** Some CIP error codes are public and can be generated also by the controller. Make sure the error was not generated by the controller.

CIP Status	Extended Status	Meaning	Cause	Help
02 hex	00CA hex	Resources unavailable Out of segments	System has no segments left to execute the command	
02 hex	03E8 hex	Resources unavailable Out of CIP com buffer	System has no CIP communication buffer left to execute the command	Check the number of parallel CIP messages send to the module. The module can process 5 CIP messages in parallel. Note that RSLinx can already consume 2 of this CIP com buffers if the online browser is active.
02 hex	0519 hex	Resources unavailable Out of command buffer	System has no command buffer left to execute the command	Call support

CIP Status	Extended Status	Meaning	Cause	Help
08 hex	0000 hex	Service not supported	The service code of the requested object is not supported	Check parameter of the CIP Message
14 hex	0000 hex	Attribute not supported	The attribute of the requested object is not supported	Check parameter of the CIP Message
13 hex	0000 hex	Insufficient data	Too little data was transferred with the CIP Message	Check the "Source Length" parameter in the parameter dialog of the CIP Message and check the consistency of all length parameter within the requested command.
15 hex	0000 hex	Configuration data size too large	Too much data transferred with the CIP Message	Check if the overall length of the requested command send with the CIP message and the consistency of all length parameter within the requested command is correct.
16 hex	0000 hex	Object not supported	The requested object does not exist within the module.	
FE hex	0000 hex	Message Timeout	No answer message was received.	
FF hex	0514 hex	General Error Non-specified error occurred		Call support
FF hex	0517 hex	General Error Unknown command / Invalid Parameter	The values in Requested Command is unknown or the parameter of the requested command are invalid	The value Req.Command must be initialized, For Read/Write Response request check if you answer with proper Slot, Index etc. from Dpv1StatusRegister



## 7 Diagnostics and Troubleshooting

### *In This Chapter*

- ❖ Web Page .....71
- ❖ Hardware LEDs .....84
- ❖ Troubleshooting .....87

This chapter details the diagnostics and troubleshooting procedures for the ILX69-PBS.

### 7.1 Web Page

You can access the ILX69-PBS web pages for general device, diagnostics information, and firmware upgrades.

#### Access to the Web Pages

- 1 Enter the IP address of the ILX69-PBS in an internet browser to access the homepage.

**ProSoft**  
TECHNOLOGY

**FUNCTIONS**

- ▶ [Module Status](#)
- ▶ [Network Status](#)
- ▶ [Firmware Update](#)

---

▶ [Technical Support](#)

▶ [Homepage](#)

### PROFIBUS Adapter Module for CompactLogix

#### ILX69-PBS

Module Name	ILX69-PBS
Ethernet Address (MAC)	00-0D-8D-A5-00-04
IP Address	10.11.5.67
Product Revision	V1.0.0.0
Firmware Version Date	2014-8-29
Serial Number	20005

**RESOURCES**

- [ProSoft Technology](#)
- [Rockwell Automation](#)



### 7.1.1 General Device and Diagnostics Information

#### Homepage

To display the ILX69-PBS homepage, click **FUNCTIONS > Homepage**.

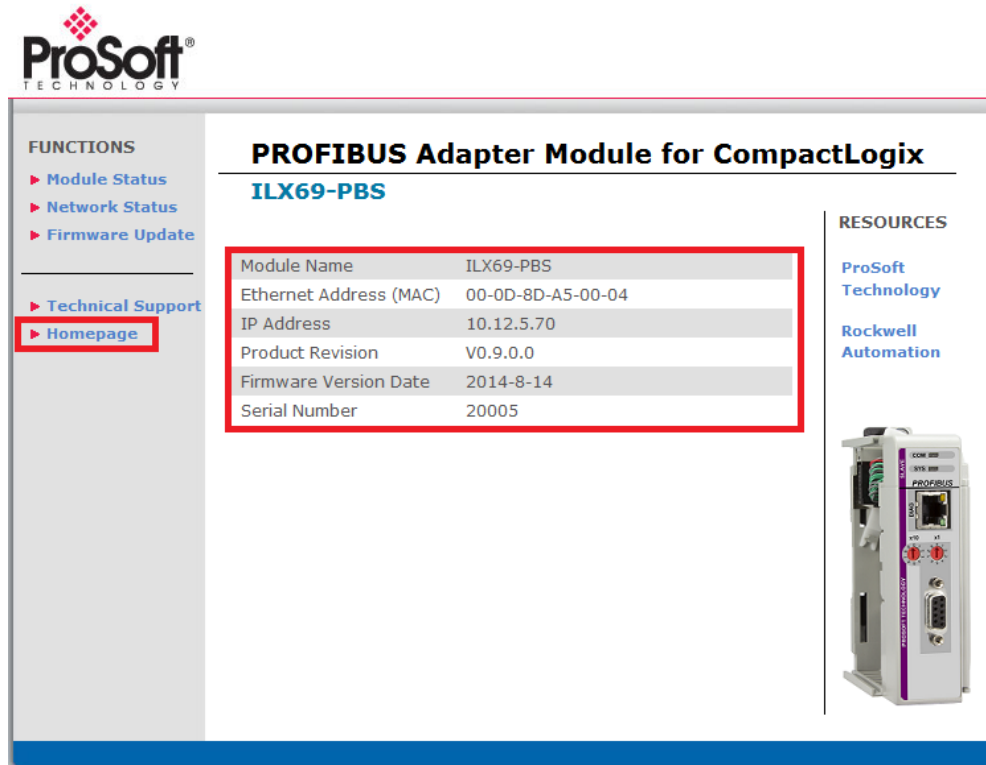

Parameter	Description	Range of Value/Value
Module Name	Name of the device as character string defined by the manufacturer	ILX69-PBS
Ethernet Address (MAC)	The MAC Address (=MAC-ID) is the unique (physical) Ethernet address of the device fixed by the manufacturer	Assigned MAC Address
IP Address	IP address of the ILX69-PBS that can be set via the ProSoft fdt Configuration Manager. The IP address must be unique. The IP address 0.0.0.0 indicates that no IP address has been configured yet.	Valid IP address
Product Revision	Revision of the ILX69-PBS firmware	V1.0.0.0 to VX.X.x.x
Firmware Version Date	Time stamp of the firmware	Year-Month-Day
Serial Number	Serial number of the ILX69-PBS	0 to 65535



Module Status

To display the ILX69-PBS status page, click **FUNCTIONS > Module Status** to access the device status and diagnostics information.

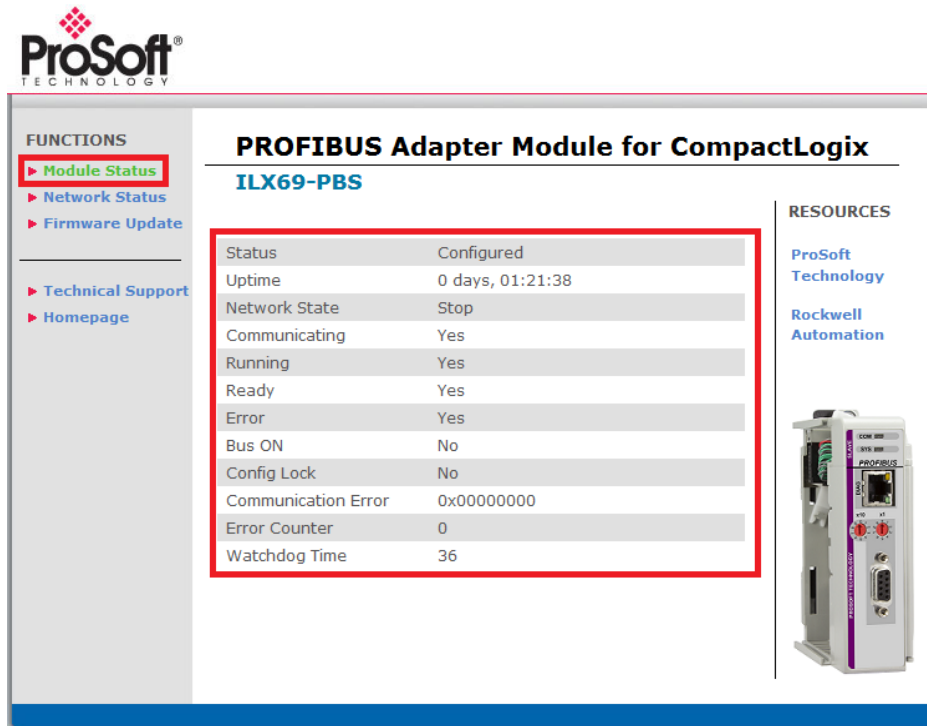

Parameter	Description	Range of Value/Value
<b>Configuration State</b>		
Status	Shows whether the ILX69-PBS is configured or not.	Configured, Not configured
Uptime	Counts up the time from the last Reset/Power On.	Days, hours, minute, seconds
<b>Network State</b>		
Network State	<p>Current status of the ILX69-PBS</p> <p><b>Operate:</b> Shows whether the ILX69-PBS is in OPERATION state, e.g. in data exchange in cyclic communication. In a cyclic data exchange, the input data or the output data of the ILX69-PBS are transmitted to the slave.</p> <p><b>Idle:</b> Shows whether the ILX69-PBS is in IDLE state.</p> <p><b>Stop:</b> Shows whether the ILX69-PBS is in STOP state, e.g. no cyclic data exchange is performed. The ILX69-PBS was stopped by the CompactLogix program or it changed to the STOP state because of a bus error.</p> <p><b>Offline:</b> Shows whether the ILX69-PBS is not in OPERATION state, e.g. no cyclic communication is performed. The ILX69-PBS is in OFFLINE state as long as it does not have a valid configuration.</p>	Operate, Idle, Stop, Offline

Parameter	Description	Range of Value/Value
<b>Device State</b>		
Communicating	Shows whether the PROFIBUS DP master executes the network communication. <b>Yes:</b> In COMMUNICATION state. The ILX69-PBS exchanges input/output data with at least one slave. <b>No:</b> Not in COMMUNICATION state. The ILX69-PBS does not exchange input/output data with slaves.	Yes, No
Running	Shows whether the ILX69-PBS has been configured correctly. <b>Yes:</b> Configuration OK <b>No:</b> Configuration not OK	Yes, No
Ready	Shows whether the ILX69-PBS has been started correctly. The ILX69-PBS waits for a configuration. <b>Yes:</b> Device is ready <b>No:</b> Device is not ready	Yes, No
Error	Shows whether the ILX69-PBS has detected an error. <b>Yes:</b> Error has been detected <b>No:</b> No error has been detected	Yes, No
<b>Configuration State</b>		
Bus ON	Shows whether the bus communication was started or stopped by the CompactLogix program. <b>Yes:</b> Bus communications have started <b>No:</b> Bus communications have not started	Yes, No
Config Lock	Configuration locked shows whether the ILX69-PBS configuration is locked, i.e. the configuration is protected against changes. <b>Yes:</b> Configuration is locked <b>No:</b> Configuration is not locked	Yes, No
<b>General Diagnostics</b>		
Communication Error	Shows the communication error code. If the cause of the error is resolved, the value will be set to zero again. All possible numbers are listed in [1].	0x00000000 to 0xFFFFFFFF
Error Counter	Counter; counts up for each error event.	0x00000000 to 0xFFFFFFFF
Watchdog Time	The Watchdog time determines the time frame in which the device watchdog must be re-triggered from the CompactLogix program while the CompactLogix program monitoring is activated. When the watchdog time value is equal to 0, the watchdog is deactivated and the CompactLogix program monitoring is deactivated also.  The permissible range of values of the watchdog time is 20 to 65535 ms. The default watchdog time is 1000 ms. With a watchdog time, the software watchdog is deactivated.	20 to 65535 ms Default: 1000 ms

Network Status

To display the ILX69-PBS network status page, click **FUNCTIONS > Network Status**. This page contains network status and diagnostics information.

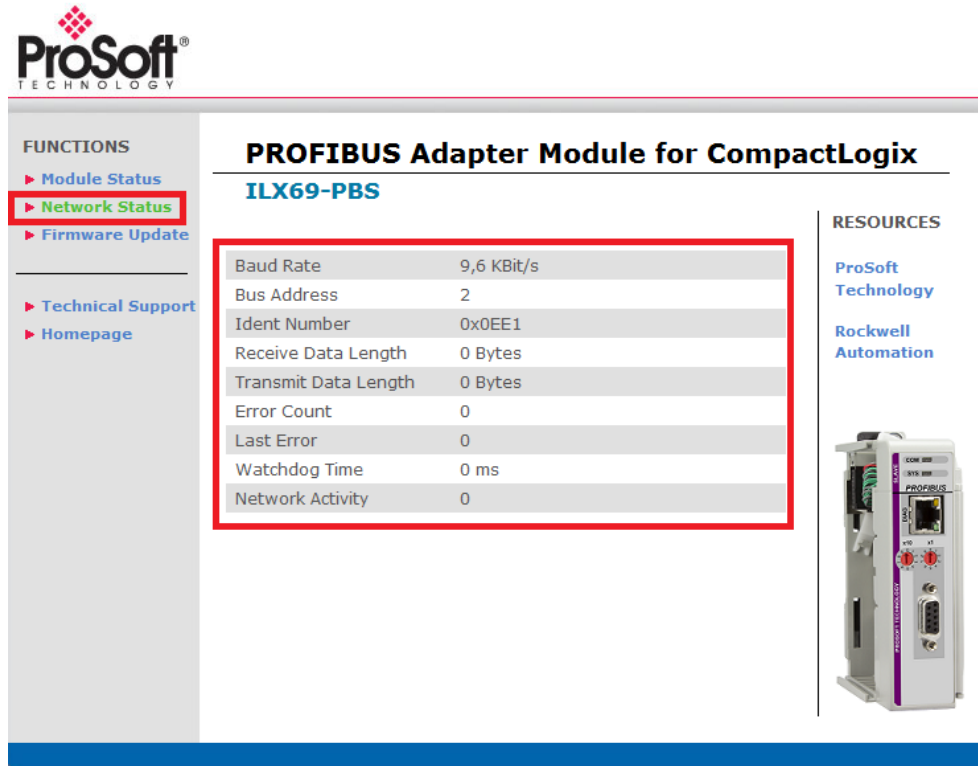

Parameter	Meaning	Range of Value/Value
Baud Rate	PROFIBUS Network Baud Rate	9.6 kBit/s 19.2 kBit/s 93.75 kBit/s 187.5 kBit/s 500 kBit/s 1.5 MBit/s 3 MBit/s 6 MBit/s 12 MBit/s 31.25 kBit/s 45.45 kBit/s Default: 9.6 kBit/s
Bus Address	PROFIBUS Network address of the ILX69-PBS	0 to 126
Ident Number	PROFIBUS identification number	0x00000000 to 0x0000FFFF (hex), Default: 0x0EE1
Receive Data Length	Total of the input identifier bytes of the modules 5 to 8	0 to 244
Transmit Data Length	Total of the output identifier bytes of the modules 1 to 4	0 to 244

Parameter	Meaning	Range of Value/Value
Error Count	This field holds the total number of errors detected since power-up. The protocol stack counts all of errors in this field no matter whether they were network related or caused internally.	0 to 65535 (rollover possible)
Last Error	Last occurred error (see appropriate Application Programming Manual)	
Watchdog Time	Shows the watchdog time in milliseconds	20 to 65535 ms Default: 1000 ms
Network Activity	Shows whether the bus communication was started or stopped. i.e. Whether the slave is active on the bus or no bus communication to the slave is possible and no response messages are sent.	

### 7.1.2 Firmware Update

Click **FUNCTIONS > Firmware Update** to access the firmware update page.

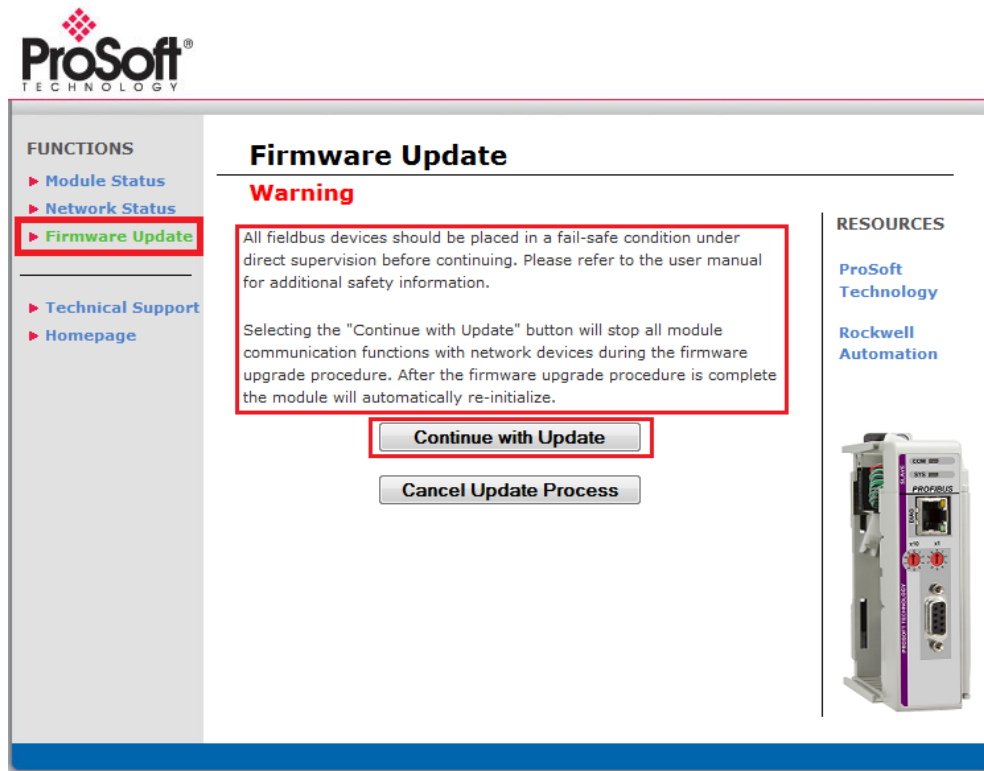

#### **⚠ WARNING**

- All fieldbus devices should be placed in a fail-safe condition under direct supervision before continuing.
- Selecting the **Continue with Update** button will stop all module communication functions with network devices during the firmware upgrade procedure.
- Stop the PLC program before you start the firmware update.

After the firmware upgrade procedure is complete, the module will automatically re-initialize. To continue the firmware update click **Continue with Update**. The firmware file prompt displays.

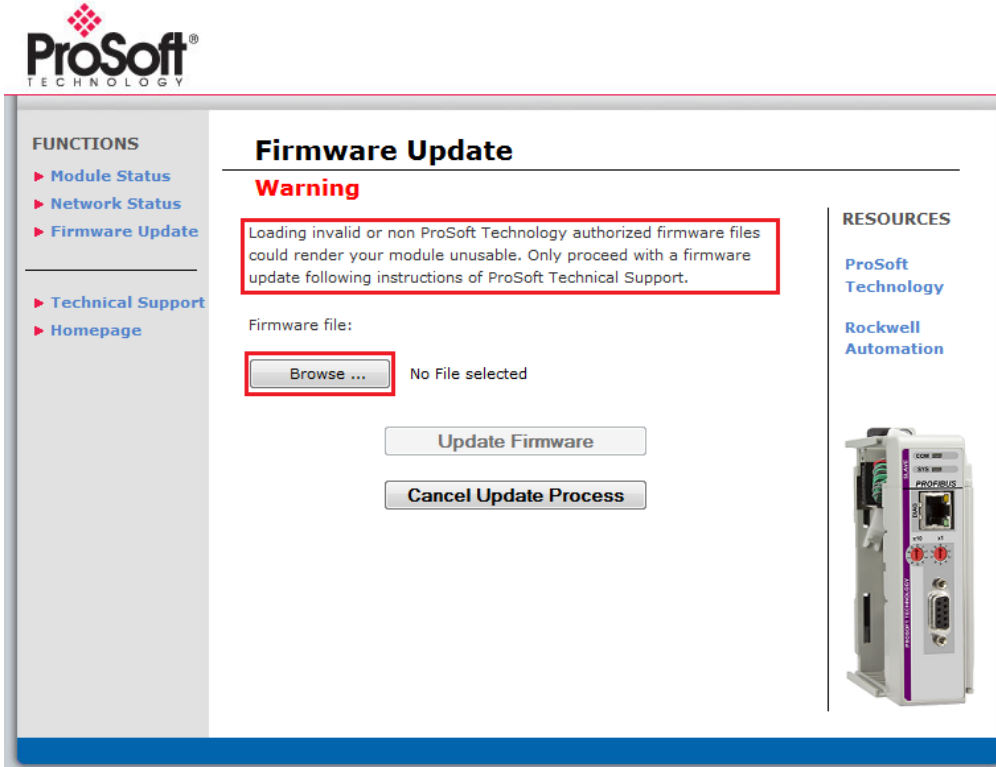

### NOTICE

- Loading invalid or non-ProSoft Technology authorized firmware files could render your module unusable. Only proceed with a firmware update following instructions of ProSoft Technical Support.

- 1 Click **Browse ...** and enter 'User name' = 'admin' and 'Password' = 'admin' to the Authorization window, and then select the firmware file.

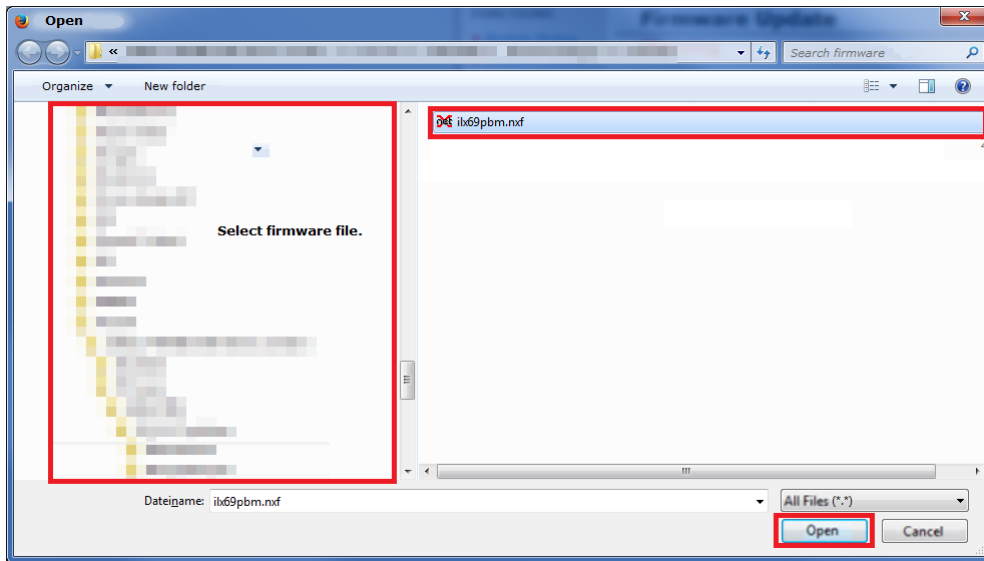

- 2 Click **Open**. The name of the selected firmware file displays.

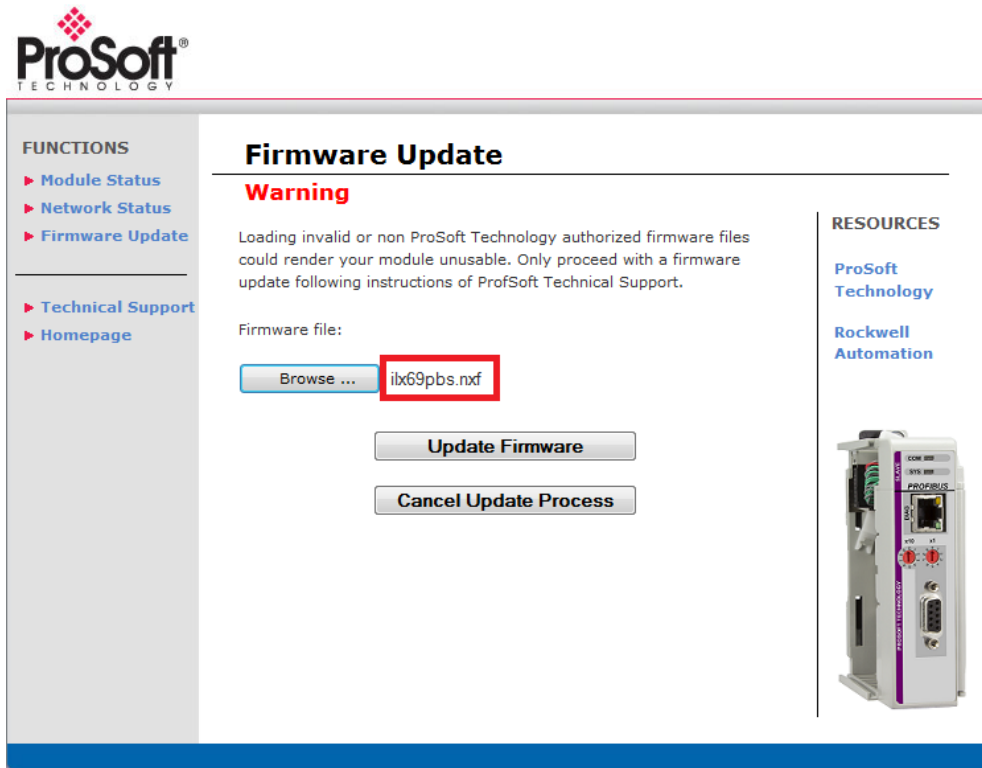

3 Click **Update Firmware**.

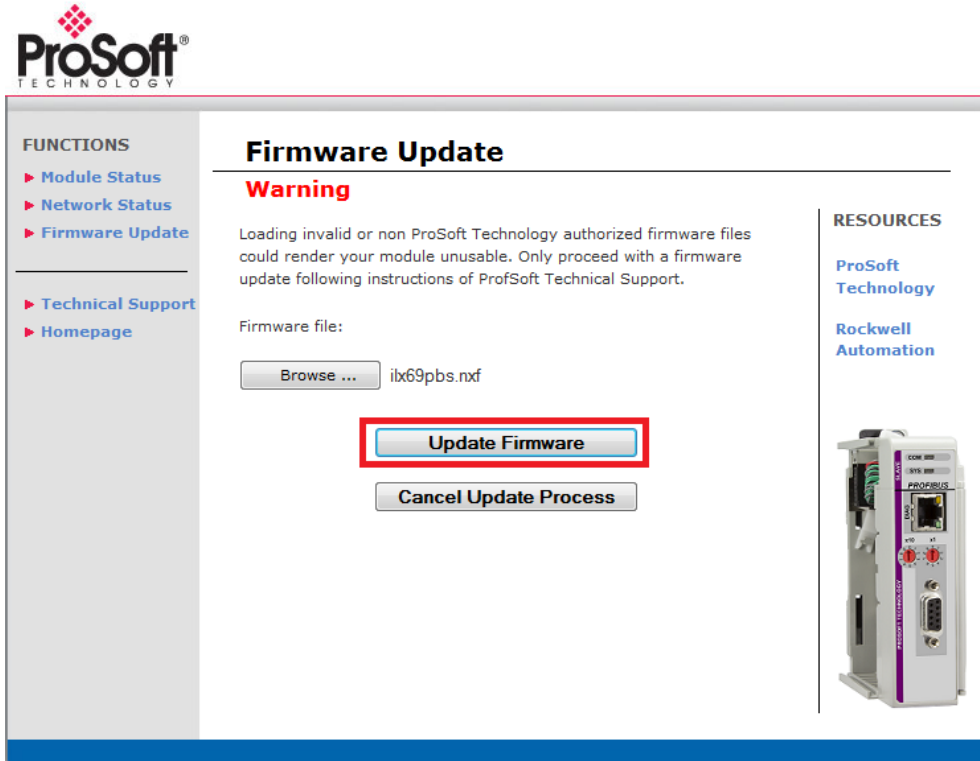

If the firmware update fails, the page shows an error message: *Firmware update error: Invalid device class.*

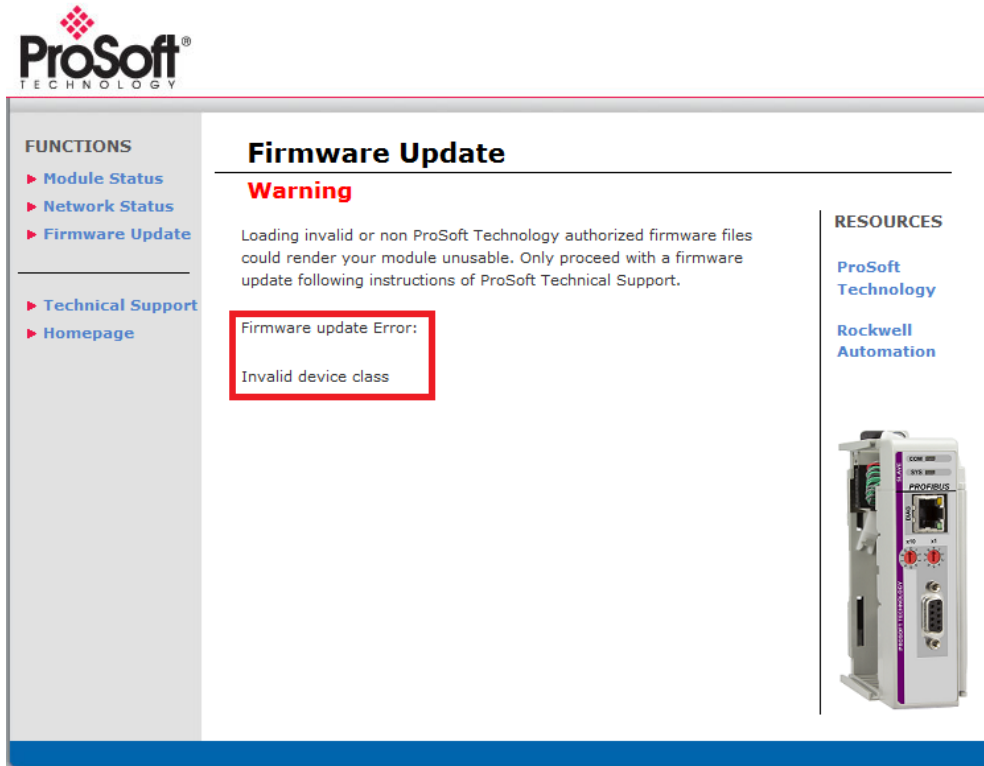



- 4 If the firmware update is successful, 'Firmware update OK' is displays. To complete the update process, click **Reset Device**.

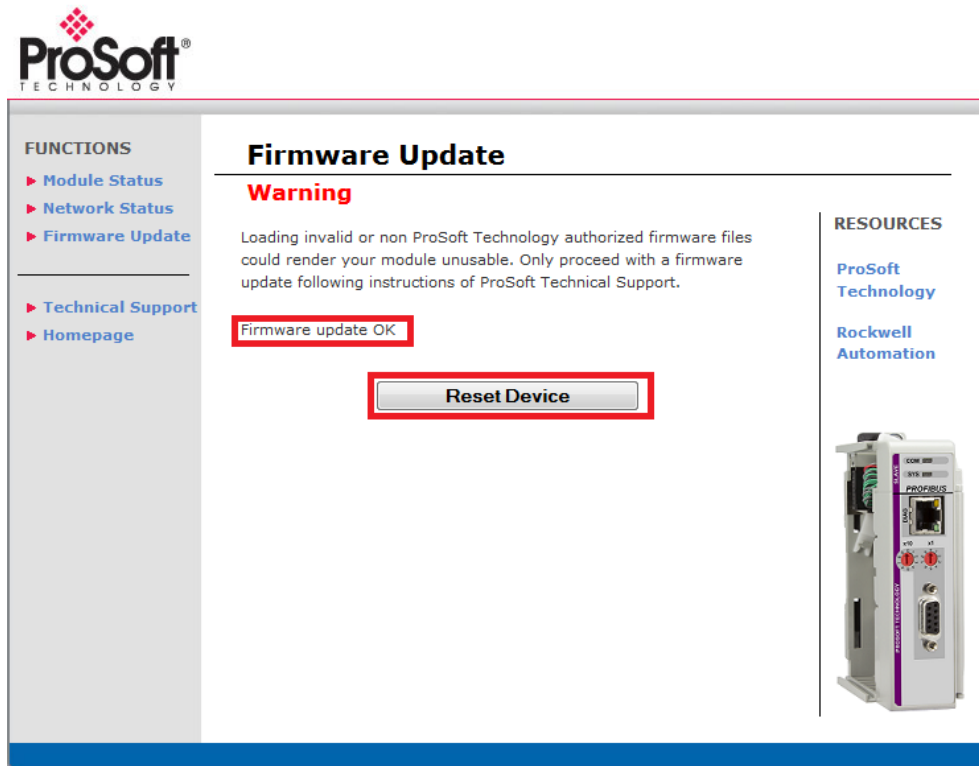

- Initiating a device reset causes the device reboot. A reboot will let the device **stop all communication** immediately. Established connections will drop.
- Non-volatile device parameters that have not been saved, such as a temporary IP address, will be lost during the reset.
- Before you initiate a reset, make sure your system is in an idle state and operating under maintenance conditions. This will prevent personal injury or system damages.

5 Check the **Please confirm you want to reset the device** box

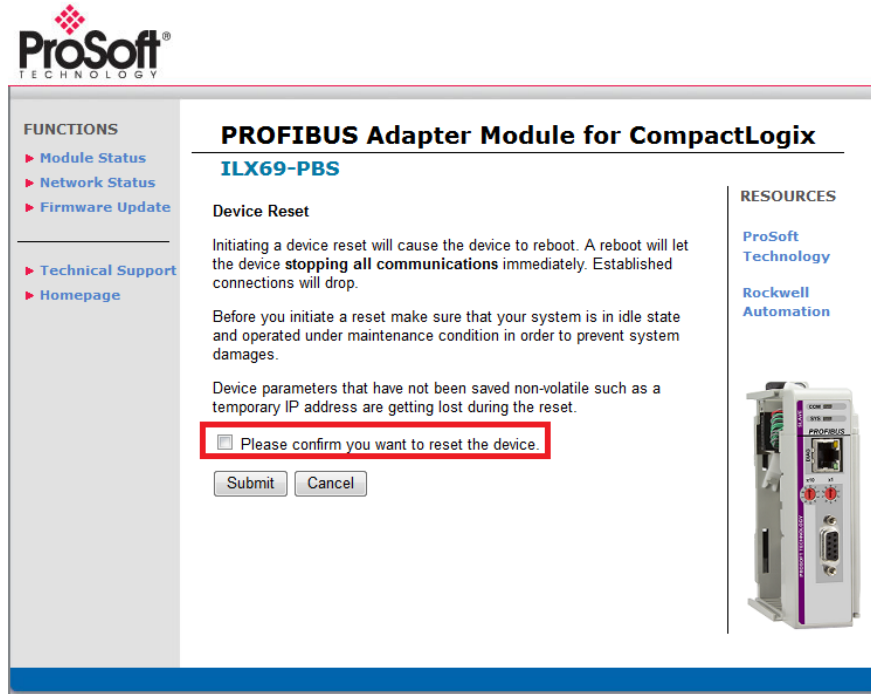

6 Click **Submit**.

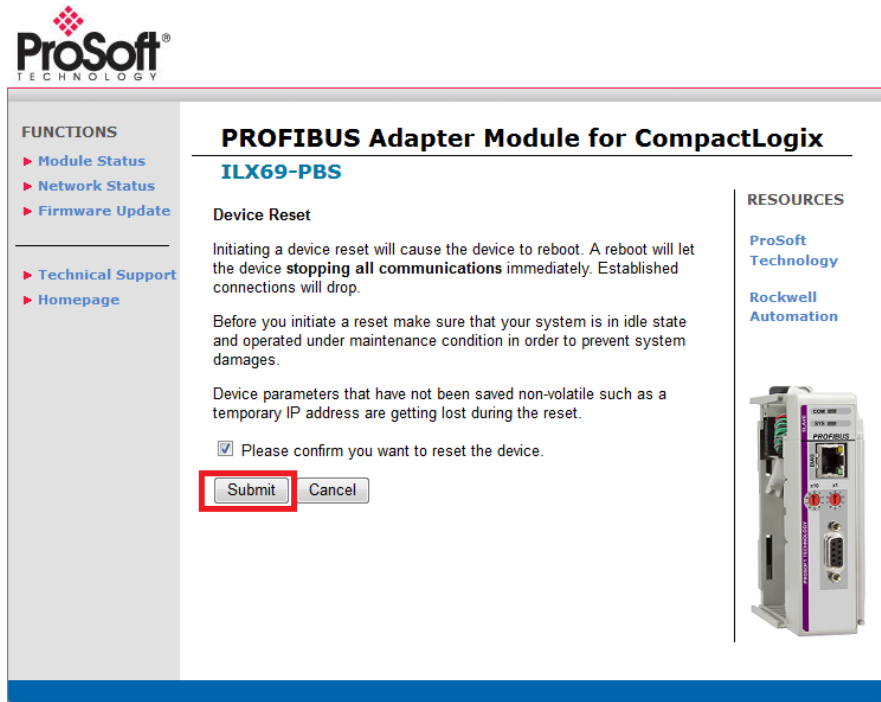

When complete, the following dialog will display:

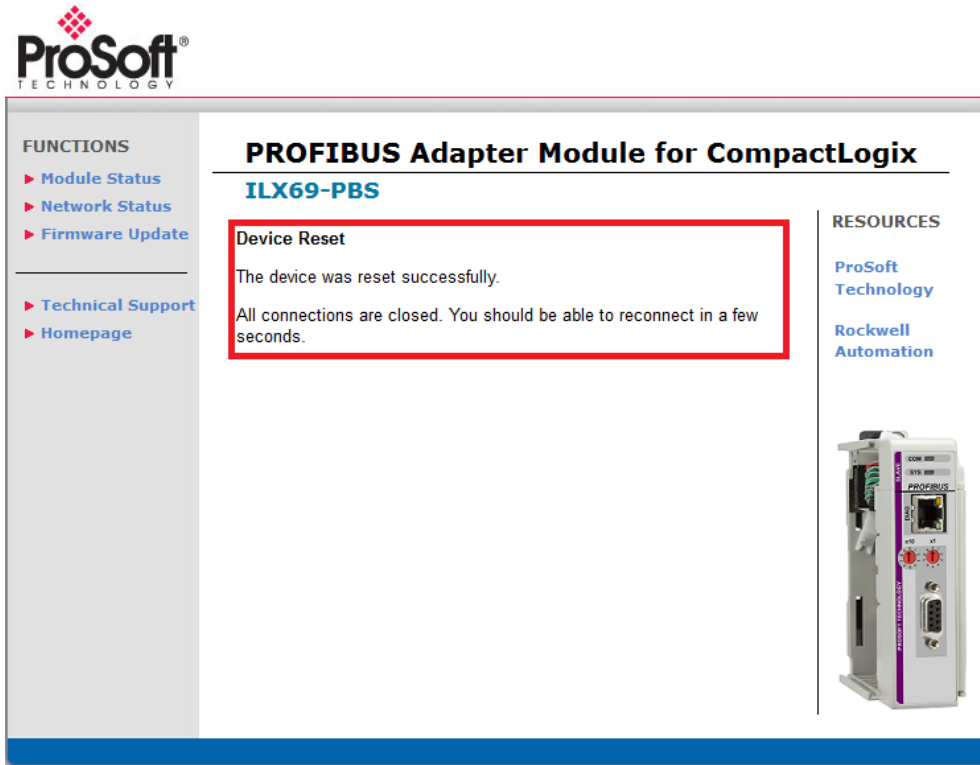













## 7.2 Hardware LEDs

The following section contains LED descriptions for the CompactLogix™ controller and the ILX69-PBS.

### 7.2.1 CompactLogix LEDs

The CompactLogix™ PLC LEDs are described below.

LED	Color	State	Description
<b>RUN</b>	 (Green)	On	One or more tasks are running; controller is in Run mode.
	 (Off)	Off	No task(s) running; controller is in Program mode.
<b>FORCE</b>	 (Amber)	Flashing	One or more input or output addresses have been forced to an On or Off state, however the forces have not been enabled.
	 (Amber)	Amber	Forces enabled
	 (Off)	Off	No forces enabled
<b>OK</b>	 (Green)	On	Controller OK
	 (Red)	Flashing	Recoverable controller fault
	 (Red)	On	Non-recoverable controller fault: Cycle power. The OK LED should change to flashing red. If OK LED remains solid red, replace the controller.
	 (Off)	Off	No power applied
<b>I/O</b>	 (Green)	On	Communicating to all devices
	 (Green)	Flashing	One or more devices not responding
	 (Red)	Flashing	Not communicating to any devices Controller faulted
	 (Off)	Off	No activity; no I/O or communications configured





LED State	Description
On	The indicator is constantly on
Off	The indicator is constantly off
Blinking	The indicator turns on and off cyclically

## 7.2.2 ILX69-PBS LEDs

The ILX69-PBS LEDs indicate the status information. Each LED has a specific function during Run, configuration download, and error indications.





### Communication Status

The ILX69-PBS PROFIBUS DP **COM** LED status is described below.

LED	Color	State	Meaning
<b>COM</b>	Duo LED red/green		
	 (Green)	On	RUN, cyclic communication
	 (Red)	Flashing cyclic	STOP, no communication, connection error
	 (Red)	Flashing acyclic	Not configured
	 (Red)	On	Wrong configuration at ILX69-PBS PROFIBUS DP slave





### PROFIBUS System Status

The **SYS** PROFIBUS network status LED is described below.

LED	Color	State	Description
<b>SYS</b>	Duo LED yellow/green		
	 (Green)	On	Operating system running
	 (Green/Yellow)	Blinking Green/Yellow	Second stage bootloader is waiting for firmware
	 (Yellow)	Static	Bootloader netX (= romloader) is waiting for second stage bootloader
	 (Off)	Off	Power supply for the device is missing or hardware defect

### Diagnostic Status

The **DIAG** Ethernet Status LEDs are described below.

LED	Color	State	Description
<b>LINK</b>	LED Green		
	 (Green)	On	The device is linked to the Ethernet network
	 (Off)	Off	The device has no link to the Ethernet network
<b>ACT</b>	LED Yellow		
	 (Yellow)	Flickering (load dependant)	The device is sending/receiving Ethernet frames
	 (Off)	Off	The device is not sending/receiving Ethernet frames

Error Sources and Reasons

This section describes the typical problems and sources of error that come up while commissioning the ILX69-PBS.

Behavior	Significance	Typical Reason	Help
CompactLogix™ I/O LED is flashing green	No communication with the ILX69-PBS (or other modules)	- Modules slot number in Studio 5000 program does not match with the physical slot of the module - Configured Input / Output / Configuration array size is wrong	- Check modules slot number in Studio 5000 project - Compare configured Input / Output size with required values
ILX69-PBS COM LED is off SYS LED flashing irregular green	Configuration missing or faulty	No configuration or faulty stored	- Check initialization values of the configuration array - Check the value "LastError" in SlaveStatusField to determine the error reason
	Watchdog expired	Watchdog value in configuration is smaller than RPI (Requested Packet Intervall)	- Increase Watchdog value in configuration array - Module has to be reset
ILX69-PBS COM LED is off and SYS LED flashing cyclic fast green	Application is not ready	- PLC is not in RUN mode - PLC application has set the NRDY bit - PLC has no I/O communication with the module	- Bring PLC into RUN Mode. - Check that the PLC application has deleted the NRDY bit. - Check PLC's I/O LED
	Master and slave Configuration mismatch	The configuration of the master which wants to communicate with the module don't match to the configuration of the slave module	- Use the ExtStaInfo in SlaveStatusField to compare what the expected configuration is from the master and the modules configuration
	Network problem	No physical network connection No master present who wants to communicate	- Check if the slave module is properly connected to the PROFIBUS Network - Check if bus activity can be detected in "IrqCounter" in SlaveStatusField - Check if a master is present who wants to communicate to the module and check if the slave address is correct
Master output data can not be found in Studio 5000 program	Input array mismatch	Configured input size in Studio 5000 to small	Check if the configured input size in Studio 5000 covers the mandatory size of 136 byte status data plus the size of the outputs configured.
Inputs are not transferred to master although PROFIBUS is running	Output array mismatch	Configured output size in Studio 5000 to small	Check if the configured output size in Studio 5000 covers the mandatory size of 4 byte status data plus the configured PROFIBUS input data

## 7.3 Troubleshooting

Troubleshooting of the system is done by examining the LEDs on the front panel of the PLC and the LEDs on the front of the module. The following can help with troubleshooting.

### LINK-LED

- Check the LINK LED status to see if a connection to the Ethernet is established. See section Ethernet Status (page 85).

### Cable

- Check the pin assignment of each connector on the PROFIBUS cable.
- Check if the bus termination resistors are switched on at each end of the cable, and switched off at all other connectors in between.





## 8 Technical Data

### *In This Chapter*

- ❖ Technical Data - ILX69-PBS .....89
- ❖ Technical Data - PROFIBUS .....92

### 8.1 Technical Data - ILX69-PBS



**Note:** All technical data can be altered without notice.

ILX69-PBS	Parameter	Value
General	Description	PROFIBUS DP slave module
	Function	PROFIBUS slave slot extension module for Rockwell CompactLogix™ 1769 system which allows the PLC to control exchange data on a PROFIBUS network.
	Memory card	SD and SDHC card. Both types are supported if the card features a SPI interface. The FAT12/16/32 formats are supported. The exFAT format is not supported. Capacity: Max. 4 GByte Refer to section Removable Memory Card
Communication Controller	Type	netX 100 processor
Integrated Memory	RAM	8 MB SDRAM
	FLASH	16 MB serial Flash EPROM
	SD Card Connector	e.g. FPS009-2405-0 push/push
	Host Interface	1769 Backplane
PROFIBUS Communication	Supported communication protocol	PROFIBUS DP slave
PROFIBUS Interface	Transmission rate	9.6 kBit/s, 19.2 kBit/s, 31.25 kBit/s, 45.45 kBit/s, 93.75 kBit/s, 187.5 kBit/s, 500 kBit/s, 1.5 MBit/s, 3 MBit/s, 6 MBit/s, 12 MBit/s
	Interface Type	RS-485, according EN 50170, refer to section PROFIBUS Interface
	Galvanic Isolation	Isolated
	Isolation Voltage	500 VDC (from backplane)

ILX69-PBS	Parameter	Value
	Connector	D-Sub female Connector, 9 pin
Ethernet Interface (Diagnostics Interface)	Transmission rate	100 MBit/s, 10 MBit/s (depending on loaded firmware)
	Interface Type	100 BASE-TX, 10 BASE-T
	Galvanic Isolation	Isolated
	Isolation Voltage	500 VDC (from backplane)
	Half duplex/Full duplex	Supported (at 100 MBit/s)
	Auto-Negotiation	Supported
	Auto-Crossover	Supported
	Connector	RJ45 Socket
Display	LED Display	<b>COM</b> Communication status <b>SYS</b> System status <b>LED yellow, green</b> RJ45 for Ethernet Link and Activity status Refer to section Hardware LEDs (page 84)
Power supply	Supply Voltage	+5 VDC ±5 %, refer to section Power Supply for ILX69-PBS
	Maximum Current at 5 V (typically)	570 mA
	Power distance rating	2 slots
	Connector	Backplane
Environmental Conditions	Operating temperature range*	0 °C (32°F) to +60°C (140°F)
	Storage temperature range	-40 °C (-40°F) to +85 °C (185°F)
	Humidity	5% to 95% relative humidity, no condensation permitted
	Environment	For UL compliant usage: The device must be used in a pollution degree 2 environment.
Device	Dimensions (L x W x H)	131.6 x 92.1 x 39.3 mm
	Mounting/Installation	Rockwell backplane interface, refer to section ILX69-PBS Hardware Installation (page 23)
	RoHS	Yes
	Weight	152 g
Power supply	Supply Voltage	+5 VDC ±5 %, refer to section Power Supply for ILX69-PBS
	Maximum Current at 5 V (typically)	570 mA
	Power distance rating	2 slots
	Connector	Backplane
Environmental Conditions	Operating temperature range*	0 °C (32°F) to +60°C (140°F)
	Storage temperature range	-40 °C (-40°F) to +85 °C (185°F)
	Humidity	5% to 95% relative humidity, no condensation permitted
	Environment	For UL compliant usage: The device must be used in a pollution degree 2 environment.
Device	Dimensions (L x W x H)	131.6 x 92.1 x 39.3 mm

ILX69-PBS	Parameter	Value
	Mounting/Installation	Rockwell backplane interface, refer to section ILX69-PBS Hardware Installation (page 23)
	RoHS	Yes
	Weight	152 g
UL Certification (in Preparation)	The device is certified according to UL 508	UL/cUL Class 1 Div 2
PROFIBUS conformance		PROFIBUS PI certification pending
Configuration	Configuration software slave	Master configuration software or CompactLogix™ PLC program

### Environmental Specifications

Environmental Specifications Type	Measurements	Norm
Emission	Radiated Emission E-Field	DIN EN 61131-2; CISPR 16, EN 55011
	Conducted Emission	DIN EN 61131-2; CISPR16, EN55011
Immunity	Immunity to Electrostatic Discharge (ESD)	DIN EN 61131-2; IEC 61000-4-2
	Immunity to Burst	DIN EN 61131-2; IEC 61000-4-4
	Immunity to Surge	DIN EN 61131-2; IEC 61000-4-5
	Immunity to Radiated Electromagnetic Field	DIN EN 61131-2; IEC 61000-4-3
	Immunity to Conducted RF	DIN EN 61131-2; IEC 61000-4-6
Climate Test	Dry Heat Withstand	DIN EN 61131-2; Clause 6.2, DIN EN 60068; -2-2 Bb
	Cold Withstand	DIN EN 61131-2; Clause 6.2, DIN EN 60068; -2-1 Ab
	Dry Heat Immunity	DIN EN 61131-2; Cl. 12.1.5 / 11.6, DIN EN 60068; -2-2 Bd
	Cold Immunity	DIN EN 61131-2; Cl. 12.1.5 / 11.6, DIN EN 60068; -2-1 Ad
Mechanical Test	Vibration Sinusoidal	DIN EN 61131-2; Clause 6.3.1, DIN EN 60068; -2-6 Fc
	Shock Test	DIN EN 61131-2; Clause 6.3.2, DIN EN 60068; -2-27 Ea

## 8.2 Technical Data - PROFIBUS

Parameter	Description
Maximum number of cyclic input data	244 bytes
Maximum number of cyclic output data	244 bytes
Maximum number of acyclic data (read/write)	240 bytes/telegram
Maximum number of modules	24
Configuration data	Max. 244 bytes
Parameter data	237 bytes application specific parameters
Acyclic communication	DP V1 Class 1 Read/Write DP V1 Class 1 Alarm DP V1 Class 2 Read/Write/Data Transport
Baud rate	9.6 kBits/s, 19.2 kBits/s, 31.25 kBits/s, 45.45 kBits/s, 93.75 kBits/s, 187.5 kBits/s, 500 kBits/s, 1.5 MBits/s, 3 MBits/s, 6 MBits/s, 12 MBit/s Auto baudrate detection is supported
Data transport layer	PROFIBUS FDL
Limitations	SSCY1S – Slave to slave communication state machine not implemented. Data exchange broadcast not implemented. Configuration by database not implemented yet. I&M LR services other than Call-REQ/RES are not supported yet.
Reference to firmware/stack version	V2.7.x.x

## 9 Annex

### In This Chapter

❖ PROFIBUS Functionality .....	93
❖ Disposal of Electronic Equipment Waste .....	95
❖ References .....	95
❖ Glossary.....	96

### 9.1 PROFIBUS Functionality

#### 9.1.1 DPV0 Services

PROFIBUS DPV0 services refer to the cyclic data exchange mechanism between a class 1 master and a slave. PROFIBUS DP defines two types of masters:

- A class 1 master handles data communication with slaves assigned to it
- A class 2 master is used for commissioning purposes

In a PROFIBUS message, class 1 masters and slaves transmit up to 244 bytes. Valid station addresses on a PROFIBUS network range from 0 to 126.

#### Fail Safe Mode

For safety reasons, the PROFIBUS DP master informs the slaves of its current control status at certain intervals using a "Global Control" message. If the master goes to Clear Mode, the Fail Safe enabled slaves will switch to a Fail Safe state. Slaves capable of the Fail Safe state can be configured to either to hold the last state of the outputs or set its outputs to "0". Slaves that do not support the Fail Safe state set their outputs to "0".

#### Global Control

With the Global Control message, the master can send unsolicited commands like Sync/Unsync, Freeze/Unfreeze and Clear Data to a slave or a group of slaves for synchronization purposes. Group membership is defined in the master during PROFIBUS network start-up.

### Sync and Freeze

Sync and Freeze are optional commands and slaves do not need to support them. The slaves must be able to process the Global Control message. With a Freeze command, the master prompts a slave or a group of slaves to "freeze" their inputs to the current state. A Sync command causes the current output data to latch at their current state until the next Sync message arrives. Unfreeze and Unsync cancel each corresponding state.

### Extended Device Diagnosis

Using diagnostics messages, the slave informs the network master of its current state in a high-priority message. The first 6 bytes of the diagnostics message are comprised of information such as its identity code ("Ident Number") and correct/incorrect configuration. The remaining bytes of this message are referred to as Extended Device Diagnostics, containing information that is specific to the particular slave.

### Watchdog

Using the Watchdog functionality, a network slave is able to monitor bus traffic. This ensures that the network master is still active, with process data still being updated. The Watchdog time is configured in ProSoft fdt Configuration Manager and is transmitted from the master to the slave during the network start-up phase. If the Watchdog timeout has been reached, the slaves go to their Fail Safe state (if supported) or set their outputs to "0".

## **9.1.2 DPV1 Services**

As an addition to cyclic DPV0 services, acyclic services called Read, Write and Alarm were added to PROFIBUS. These services are referred to as DPV1. With DPV1, it is possible to address individual slaves within the network. In addition, DPV1 services allow the transfer of non-time critical data to slaves. DPV1 data exchange takes place after cyclic data exchange in a PROFIBUS network cycle.

### Read Request

With a Read Request message, the class 1 master can read data addressed by slot and index within the data range of a slave device. This may take several DPV0 cycles. If the master discovers a timeout, it aborts both DPV1 and DPV0 communication with the slave. The communication to the slave must be re-established. The master initiates the Read Request service.

### Write Request

With a Write Request message, the class 1 master can write data to a slave, addressed by slot and index. The timeout handling is identical to the Read Request. The master initiates the Write Request service.

### Alarm Indication

DPV1 Alarm handling is an addition to the Device Diagnostics function in a PROFIBUS message. Alarms are reported to the master as device-specific diagnostics information. The slave initiates an Alarm Indication. Other than Device Diagnostics messages, Alarms must be acknowledged by the master.

### Start/Stop Communication

PROFIBUS communications can be started/stopped by using the "NRDY" (NotReady) Bit. When this bit is set, the communication between the ILX69-PBS and all slaves is stopped. All slaves will clear their outputs and the master will be in stop mode. This control bit allows the user program to make a controlled start of the communication with the PROFIBUS network.

## 9.2 Disposal of Electronic Equipment Waste

As a consumer, you are legally obliged to dispose of all electronic equipment waste according to national and local regulations.



### **Waste Electronic Equipment**

- This product must not be treated as household waste.
- This product must be disposed of at a designated waste electronic equipment collecting point.

## 9.3 References

- [1] PROFIBUS DP Slave Protocol API Manual, Revision 19, Hilscher GmbH 2013
- [2] PROFIBUS DP Slave Protocol API Manual, Revision 15, Hilscher GmbH 2013

## 9.4 Glossary

### **Baud rate**

Data transmission speed of a communication channel or interface.

### **Boot loader**

Program loading the firmware into the memory of a device in order to be executed.

### **Device Description File**

A file containing configuration information about a device being a part of a network that can be read out by the master for system configuration. Device Description Files use various formats that depend on the communication system.

### **DHCP**

Dynamic Host Configuration Protocol. This is a protocol simplifying the configuration of IP networks by automatically assigning IP addresses.

### **DP**

Decentralized Periphery

### **DPM**

Dual-Port Memory

### **DTM**

The Device Type Manager (DTM) is a software module with a graphical user interface for the configuration or for diagnostics of device.

### **Ethernet**

A networking technology used both for office and industrial communication via electrical or optical connections. It provides data transmission with collision control and allows various protocols. As Ethernet is not necessarily capable for real-time application, various real-time extensions have been developed.

### **FDL**

Fieldbus Data Link defines the PROFIBUS communication on layer 2, identical for DP and FMS

### **FDT**

Field Device Tool (FDT) specifies an interface in order to be able to use DTM (Device Type Manager) in different applications of different manufacturers.

### **Firmware**

Software providing the basic functionality of this device. The firmware is stored permanently in the flash memory circuit of the device. It can be updated by a firmware download.

### **GSD / GSE**

**Generic Station Description / English, Device description file**



**GSD file**

A special kind of Device Description File used by PROFIBUS (GSD = Generic Station Description).

**IP Address**

Address within IP (the Internet Protocol, part of TCP/IP).

An IP address is an address identifying a device or a computer within a network using the IP protocol. IP addresses are defined as a 32-bit number. For ease of notation, the IP address is divided into four 8 bit numbers which are represented in decimal notation and separated by points:

a.b.c.d

where a.b.c.d are each integer values between 0 and 255.

Example: 192.168.30.15

However, not all combinations are allowed, some are reserved for special purposes.

The IP address 0.0.0.0 is defined as invalid.

**PROFIBUS Adapter**

PROFIBUS DP slave module

**PROFIBUS Scanner**

PROFIBUS DP master module

**ProSoft fdt Configuration Manager**

FDT/DTM based configuration and diagnostics software by ProSoft Technology, Inc.

**RJ45**

A connector type often used for Ethernet connection. It has been standardized by the Federal Communications Commission of the USA (FCC).

**RSLogix™ 5000**

PLC design and configuration software from Rockwell Automation

**Studio 5000**

Logix Designer for PowerFlex Drives from Rockwell Automation

**Second Stage Boot Loader (SSL)**

Loads an operating systems or parts of it as soon as the boot loader has finished

**Watchdog Timer**

A watchdog timer provides an internal supervision mechanism of a communication system. It monitors an event occurrence within a given time frame (adjustable) and causes an alarm otherwise. Usually this is accomplished by changing the operational state of the communication system to a safe state.



## 10 Support, Service & Warranty

### In This Chapter

- ❖ Contacting Technical Support.....99
- ❖ Warranty Information .....100

### 10.1 Contacting Technical Support

ProSoft Technology, Inc. is committed to providing the most efficient and effective support possible. Before calling, please gather the following information to assist in expediting this process:

- 1 Product Version Number
- 2 System architecture
- 3 Network details

If the issue is hardware related, we will also need information regarding:

- 1 Module configuration and associated ladder files, if any
- 2 Module operation and any unusual behavior
- 3 Configuration/Debug status information
- 4 LED patterns
- 5 Details about the serial, Ethernet or Fieldbus devices interfaced to the module, if any.

**Note:** For technical support calls within the United States, ProSoft's 24/7 after-hours phone support is available for urgent plant-down issues. Detailed contact information for all our worldwide locations is available on the following page.

---

<b>Internet</b>	Website: <a href="http://www.prosoft-technology.com">www.prosoft-technology.com</a> E-mail address: support@prosoft-technology.com
<b>Asia Pacific</b> (location in Malaysia)	Tel: +603.7724.2080 E-mail: asiapc@prosoft-technology.com Languages spoken include: Chinese, English
<b>Asia Pacific</b> (location in China)	Tel: +86.21.5187.7337 x888 E-mail: asiapc@prosoft-technology.com Languages spoken include: Chinese, English
<b>Europe</b> (location in Toulouse, France)	Tel: +33 (0) 5.34.36.87.20 E-mail: support.EMEA@prosoft-technology.com Languages spoken include: French, English
<b>Europe</b> (location in Dubai, UAE)	Tel: +971-4-214-6911 E-mail: mea@prosoft-technology.com Languages spoken include: English, Hindi
<b>North America</b> (location in California)	Tel: +1.661.716.5100 E-mail: support@prosoft-technology.com Languages spoken include: English, Spanish
<b>Latin America</b> (Oficina Regional)	Tel: +1-281-2989109 E-Mail: latinam@prosoft-technology.com Languages spoken include: Spanish, English
<b>Latin America</b> (location in Puebla, Mexico)	Tel: +52-222-3-99-6565 E-mail: soporte@prosoft-technology.com Languages spoken include: Spanish
<b>Brasil</b> (location in Sao Paulo)	Tel: +55-11-5083-3776 E-mail: brasil@prosoft-technology.com Languages spoken include: Portuguese, English

---

## 10.2 Warranty Information

For complete details regarding ProSoft Technology's TERMS & CONDITIONS OF SALE, WARRANTY, SUPPORT, SERVICE AND RETURN MATERIAL AUTHORIZATION INSTRUCTIONS please see the documents at:  
[www.prosoft-technology/legal](http://www.prosoft-technology/legal)

Documentation is subject to change without notice.

## Index

### 1

1769 Programmable Controller Functionality • 8

### A

About the ILX69-PBS • 17  
About the User Manual • 7  
Acyclic Messaging • 60  
Alarm Indication • 95  
Annex • 93

### B

Bus Address • 47

### C

CIP Messaging Error Codes • 68  
Communication • 51  
Communication Status • 85  
Communication Stop During Firmware Update • 12  
CompactLogix LEDs • 84  
Configuration and Start-Up • 27  
Configuration by Controller Application • 35, 46  
Configuration by Master • 45  
Configuration Parameters • 47  
Consideration when planning the system • 23  
Contacting Technical Support • 99  
Creating a Module in the Project Using an Add-On Profile • 28  
Creating a New Project • 35  
Creating the Module in an RSLogix 5000 Project • 27

### D

Device Command Register • 59  
Device Destruction by Exceeding Allowed Signaling Voltage • 13  
Device Destruction by Exceeding Allowed Supply Voltage • 13  
Device Destruction if ILX69-PBS is Installed to Powered PLC • 13  
Device Drawing ILX69-PBS • 17  
Diagnostics and Troubleshooting • 71  
Disposal of Electronic Equipment Waste • 95  
DPS Diagnostic Request • 61  
DPV0 Services • 93  
DPV1 Alarm • 66  
DPV1 Error Codes • 67  
DPV1 Messaging • 64  
DPV1 Read • 64  
DPV1 Services • 94  
DPV1 Write • 65

### E

Electrical Shock Hazard • 12  
Electrostatically sensitive devices • 13  
Error Sources and Reasons • 86  
Ethernet Connection Data • 21  
Ethernet Interface • 20  
Ethernet Pin Assignment at the RJ45 Socket • 20  
Ethernet Status • 85, 87  
Extended Device Diagnosis • 94

### F

Fail Safe Mode • 93  
Firmware Revision • 54  
Firmware Update • 76  
Force User Configuration • 47

### G

General Device and Diagnostics Information • 72  
General Information ILX69-PBS • 7  
General Note • 11  
Global Control • 93  
Glossary • 96  
GSD File • 45

### H

Hardware LEDs • 84, 90  
Hardware Requirements • 9  
Homepage • 72

### I

I/O Arrays Overview • 52  
I/O Communication and Memory Map • 52  
ILX69-PBS Hardware Installation • 24, 90, 91  
ILX69-PBS Input Data (PROFIBUS Network Output Data) • 59  
ILX69-PBS LEDs • 85  
ILX69-PBS Output Data (PROFIBUS Network Input Data) • 60  
Important Safety Information • 2  
Importing the Ladder Rung • 39  
Input Array • 52, 53  
Installation • 23  
Installing an Add-On Profile • 28  
Installing the ILX69-PBS Module • 24  
Intended Audience • 7  
Introduction • 7

### L

Labeling of Safety Messages • 14

### M

Manually Creating a Module in the Project • 35  
Module Properties 1 • 37  
Module Properties 2 • 38  
Module Status • 73

Module Type / Module Length • 48

## N

Network Status • 75  
Number of Valid Configuration Bytes • 48

## O

Output Array • 53, 59

## P

Personnel Qualification • 11  
Power Supply • 13, 21  
PROFIBUS Functionality • 93  
PROFIBUS Interface • 18  
PROFIBUS Network Input Data • 52  
PROFIBUS Network Output Data • 51  
PROFIBUS System Status • 85  
ProSoft Technology® Product Documentation • 2

## R

Read Request • 42, 94  
Reference Systems • 8  
References • 95  
Removable Memory Card • 21  
Requirements • 9  
Reset Device to Factory Settings with Memory Card •  
50

## S

Safety • 11  
Safety Instructions to Avoid Personal Injury • 11  
Safety Instructions to Avoid Property Damage • 12  
Safety Precautions • 24  
Safety References • 12, 13, 14, 15  
SD Card • 49  
Slave Configuration • 45  
Slave Status • 55  
Software Requirements • 9  
Standard Messaging • 61  
Start/Stop Communication • 95  
Start-up Behavior with or without SD Card • 49  
STARTUP.INI File • 50  
Status Registers • 53  
Studio 5000 PROFIBUS Data Values • 51  
Support, Service & Warranty • 99  
Supported PROFIBUS DP Messages • 60  
Sync and Freeze • 94

## T

Technical Data • 89  
Technical Data - ILX69-PBS • 89  
Technical Data - PROFIBUS • 92  
Troubleshooting • 87

## U

Uninstalling ILX69-PBS Hardware • 25  
Using an Add-On Profile • 31

## W

Warranty Information • 100  
Watchdog • 94  
Watchdog Timeout • 48  
Web Page • 71  
Wiring Instructions • 18  
Write Request • 94

## Y

Your Feedback Please • 2